

OPEL FRONTERA

Owner's Manual



Contents

| | |
|---|-----|
| Introduction..... | 2 |
| Getting To Know Your Vehicle..... | 4 |
| Seats, Restraints..... | 16 |
| Storage..... | 36 |
| Dashboard Instruments And Controls... | 40 |
| Infotainment System..... | 62 |
| Lighting..... | 76 |
| Climate Control..... | 83 |
| Driving And Operating..... | 89 |
| Advanced Driving Assistance Systems..... | 116 |
| Vehicle Care..... | 137 |
| Service And Maintenance..... | 163 |
| Technical Data..... | 165 |
| Customer Information..... | 171 |

Introduction

| | |
|-------------------------------------|---|
| Vehicle Specific Data..... | 2 |
| Using This Manual..... | 2 |
| Symbols..... | 3 |
| Propulsion Types..... | 3 |
| Internal Combustion Engine | |
| Vehicle (ICE)..... | 3 |
| Hybrid 48 V Vehicle..... | 3 |
| Battery Electric Vehicle (BEV)..... | 3 |
| Danger, Warnings and Cautions..... | 3 |

Your vehicle is a designed combination of advanced technology, safety, environmental friendliness and economy.

This Owner's Manual provides you with all the necessary information to enable you to drive your vehicle safely and efficiently.

Some functions are only operational when ignition is switched on, when combustion engine is running or when electric engine is ready.

Make sure your passengers are aware of the possible risk of accident and injury which may result from improper use of the vehicle.

You must always comply with the specific laws and regulations of the country that you are in. These laws may differ from the information in this Owner's Manual. Disregarding the description given in this manual may affect your warranty.

When this Owner's Manual refers to a workshop visit contact a qualified workshop that has the required technical information, skills and equipment. We recommend your Opel Service Partner. The customer literature pack should always be kept ready to hand in the vehicle.

We wish you many hours of pleasurable driving.

Your Opel Team

Vehicle Specific Data

Please refer to the sections "Maintenance And Vehicle Care", "Technical data", the vehicle's identification plate and national registration documents.

Using This Manual

- This manual describes all options and features available for this model. **Certain descriptions, including those for display and menu functions, may not apply to your vehicle due to model variant, country specifications, special equipment or accessories.**
- The table of contents at the beginning of this manual and within each section shows where the information is located.
- The index will enable you to search for specific information.
- This Owner's Manual depicts lefthand drive vehicles. Operation is similar for right-hand drive vehicles.
- The Owner's Manual uses the engine identifier code. The corresponding

sales designation and engineering code can be found in the section "Technical data".

- Directional data, e.g. left or right, or front or back, always relate to the direction of travel.
- Displays may not support your specific language.
- Display messages and interior labelling are written in **bold** letters.

Symbols



Environmental protection feature

Page references are indicated with ⇨.
⇨ means "see page".

Page references and index entries refer to the indented headings given in the section table of content.

Propulsion Types

Internal Combustion Engine Vehicle (ICE)

An ICE vehicle is propelled by an internal combustion engine - diesel or petrol - only.

Hybrid 48 V Vehicle

A Hybrid 48 V vehicle is propelled by a combination of an ICE and an electric engine. The electric engine supports the ICE but can also propel the vehicle by itself. The 48 V battery is mainly charged by engine braking.

Battery Electric Vehicle (BEV)

A BEV is propelled by an electric engine only. The high voltage battery is charged using a charging cable and additionally by engine braking.

Danger, Warnings and Cautions

Danger

Text marked **Danger** provides information on risk of fatal injury. Disregarding this information may endanger life.

Warning

Text marked **Warning** provides information on risk of accident or injury.

Disregarding this information may lead to injury.

Caution

Text marked **Caution** provides information on possible damage to the vehicle. Disregarding this information may lead to vehicle damage.

Getting To Know Your Vehicle

| | |
|--|----|
| Keys..... | 4 |
| Replacement Keys..... | 4 |
| Key With Foldaway Key Section..... | 5 |
| Lock Cylinders..... | 5 |
| Remote Control Function..... | 5 |
| Central Locking System..... | 6 |
| Child Lock..... | 7 |
| Doors..... | 7 |
| Tailgate..... | 8 |
| Opening..... | 8 |
| Closing..... | 8 |
| General Hints For Operating Tailgate..... | 8 |
| Vehicle Security..... | 8 |
| Anti-Theft Locking System..... | 8 |
| Anti-Theft Alarm System..... | 9 |
| Exterior Mirrors..... | 10 |
| Convex Shape..... | 10 |
| Electric Adjustment..... | 10 |
| Folding Mirrors..... | 11 |
| Heated Mirrors..... | 11 |
| Interior Mirrors..... | 12 |
| Interior Mirror Adjustment..... | 12 |
| Manual Anti-Dazzle..... | 12 |
| Automatic Anti-Dazzle..... | 12 |
| Windows..... | 12 |
| Windscreen..... | 12 |
| Power Windows..... | 13 |
| Manual Windows..... | 14 |

| | |
|-------------------------|----|
| Heated Rear Window..... | 15 |
| Sun Visors..... | 15 |

Keys

Caution

Do not attach heavy or bulky items to the ignition key.

Danger

Never remove the key from ignition switch during driving as this will cause steering wheel lock.

Replacement Keys

The key number is specified on a detachable tag.

The key number must be quoted when ordering replacement keys as it is a component of the immobilizer system.

Locks ⇨ page 160

Starting the engine ⇨ page 90

Remote control function ⇨ page 5

The code number of the adapter for the locking wheel nuts is specified on a card. It must be quoted when ordering a replacement adapter.

Wheel changing ⇨ page 153

Key With Foldaway Key Section

Caution

Never remove the key from ignition switch during driving as this will cause, depending on version, steering wheel lock.

Press button to extend. To fold the key, first press the button.

Lock Cylinders

Remote Control Function



 : unlocks the vehicle

 : locks the vehicle

Caution

The electronic components inside the key may be damaged if the key is subjected to strong shocks. In order to ensure complete efficiency of the electronic devices inside the key, it should never be exposed to direct sunlight.

- central locking system ⇒ page 6
- anti-theft locking system ⇒ page 8
- anti-theft alarm system ⇒ page 9
- tailgate unlocking ⇒ page 6
- power windows ⇒ page 13
- mirrors folding ⇒ page 11

Replacing Battery In Remote Control

Replace the battery as soon as the system no longer operates properly or the range is reduced.



Batteries do not belong in household waste. They must be disposed of at an appropriate recycling collection point.



1. To unclip the cover insert a small screwdriver between the back cover and the remote control.
2. Remove the back cover.
3. Extract the flat battery from its location.
4. Replace battery with a battery of the same type. Pay attention to the installation position.
5. Clip the cover in place.

Fault

If the central locking system cannot be operated with the radio remote control, the cause may be one of the following:

- Fault in radio remote control.

- Electronic key is out of reception range.
- The battery voltage is too low.
- The battery voltage is too high.
- Frequent, repeated operation of the radio remote control while not in range.
- Overload of the central locking system by operating at frequent intervals, the power supply is interrupted for a short time.
- Interference from higher-power radio waves from other sources.

Manual unlocking ⇒ page 6

Central Locking System

Central Locking Button

Locks or unlocks all doors, the load compartment and fuel filler flap from inside the passenger compartment.



Press  to lock. The LED in the button illuminates.

Press  again to unlock. The LED in the button extinguishes.

Automatic Locking After Driving Off

This system allows automatic locking as soon as the speed of the vehicle exceeds 10 km/h.

If the vehicle is not closed properly, the automatic locking does not take place. This is signalled by the sound of the locks rebounding, accompanied by illumination of  in the cluster, an audible signal and the display of an alert message.

Activation or deactivation



With the ignition on, press  and a corresponding message is displayed. The state of the system stays in memory when switching off the ignition.

Automatic Relock After Unlocking

This feature automatically relocks the vehicle a short time after unlocking with the remote control or electronic key, provided vehicle has not been opened.

Operation With The Key In Case Of A Central Locking System Fault

In case of a fault, e.g. vehicle battery or remote control / electronic key battery is discharged, the vehicle can be locked or unlocked with the mechanical key.

Manual Unlocking



Manually unlock the left door by inserting and turning counterclockwise the key in the lock cylinder.

By switching on the ignition, the antitheft locking system is deactivated.

The other doors can be opened by pulling the interior handle. The load compartment and fuel filler flap will possibly not be unlocked.

Manual Locking



Manually lock the left front door by inserting and turning the key in the lock cylinder. With working central locking system the vehicle will be locked.

Child Lock

Warning

Use the child locks whenever children are occupying the rear seats.



Turn the red child lock in the rear doors to the horizontal position by using a key. The door cannot be opened from the inside.

To deactivate, turn the child lock to the vertical position.

Doors

Caution

The sill panel must not be used as a step.

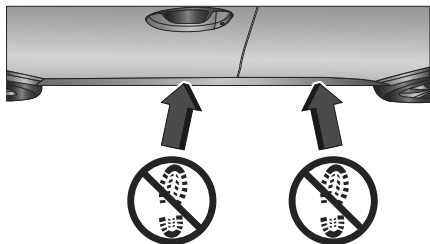

Tailgate

Opening

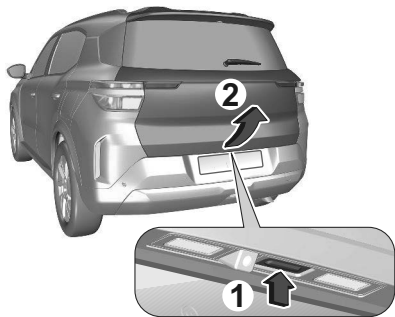

1. Press the tailgate button.
2. Open the tailgate.

Closing



Use the interior handle.
Do not push the tailgate button whilst closing as this will open the tailgate again.
Central locking system ⇒ page 6

General Hints For Operating Tailgate

Danger

Do not drive with the tailgate open or ajar, e.g. when transporting bulky objects, since toxic exhaust gases, which cannot be seen or smelled, could enter the vehicle.

This can cause unconsciousness and even death.

Caution

Before opening the tailgate, check overhead obstructions, e.g. a garage door, to avoid damage to the tailgate. Always check the moving area above and behind the tailgate.

Note

The installation of certain heavy accessories onto the tailgate may affect its ability to remain open.

Note

At low outside temperatures the tailgate may not open fully by itself. In this case lift the tailgate manually to its normal end position.

Vehicle Security

Anti-Theft Locking System

Warning

Do not use the system if there are people in the vehicle! The doors cannot be unlocked from the inside.

The system deadlocks all the doors.

All doors must be closed otherwise the system cannot be activated.

Unlocking the vehicle disables the mechanical anti-theft locking system.

This is not possible with the central locking button.

Activation



Press  on the radio remote control twice within five seconds.

Anti-Theft Alarm System

The anti-theft alarm system is combined with the anti-theft locking system. It monitors:

- doors, tailgate, bonnet
- passenger compartment including adjoining load compartment

- vehicle inclination, e.g. if it is raised
- ignition

Activation

All doors, the load compartment and the engine compartment must be closed.

The system is self-activated 45 seconds after locking the vehicle.

If a door, the tailgate or the bonnet is not properly closed, the vehicle is not locked. However, the anti-theft alarm is self-activated after 45 seconds.

Note

The automatic vehicle locking function does not activate the antitheft alarm system.

To activate the anti-theft alarm system, lock the vehicle by using the radio remote control.

Central locking system ⇒ page 6

Note

Changes to the vehicle interior such as the use of seat covers and open windows, could impair the function of passenger compartment monitoring.



Activation Without Monitoring Of Passenger Compartment And Vehicle Inclination

Switch off the monitoring of passenger compartment and vehicle inclination when animals are being left in the vehicle, because of high volume

ultrasonic signals and because movements could trigger the alarm. Also switch off when the vehicle is on a ferry or train.

1. Close tailgate, bonnet, windows.



2. Press  LED in the button  illuminates for a maximum of ten minutes.
3. Close doors.
4. Activate the anti-theft alarm system.

Indication

LED in the  button flashes if the anti-theft alarm system is activated.

Seek the assistance of a workshop in the event of faults.

Deactivation

Radio remote control: Unlocking the vehicle by pressing  deactivates the anti-theft alarmsystem.

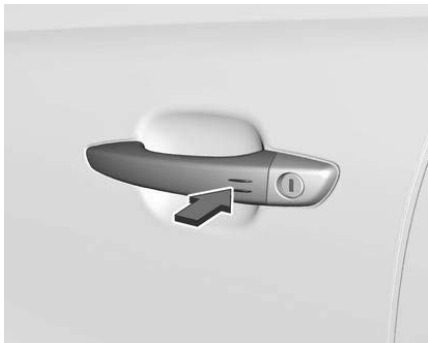

The system is not deactivated by unlocking the driver's door with the key or with the central locking button in the passenger compartment.

Alarm

When triggered, the alarm siren sounds and the hazard warning lights flash simultaneously. The number and duration of alarm signals are stipulated by legislation.

The anti-theft alarm system can be deactivated by pressing  or switching on the ignition.

A triggered alarm, which has not been interrupted by the driver, will be indicated by the hazard warning lights. They will flash quickly four times the next time the vehicle is unlocked with the radio remote control.

If the vehicle's battery is to be disconnected (e.g. for maintenance work), the alarm siren must be deactivated as follows: switch the ignition on then off, then disconnect the vehicle's battery within 15 seconds.

If the battery has been reconnected (e.g. after maintenance work), wait for ten minutes to restart the engine.

Fault

If the LED in the button  illuminates permanently when switching on the ignition, seek the assistance of a workshop.

Lock the vehicle by locking the front door with the key.

Immobilizer

The system is part of the ignition switch and checks whether the vehicle is allowed to be started with the key being used. The immobilizer is activated automatically.

Note

Radio Frequency Identification (RFID) tags may cause interference with the key.

Do not have it placed near the key when starting the vehicle.

Note

The immobilizer does not lock the doors. Always lock the vehicle after leaving it
Central locking system ⇒ page 6
Switch on the anti-theft alarm system ⇒ page 9

Exterior Mirrors

Convex Shape

The shape of the mirror makes objects appear smaller, which will affect the ability to estimate distances.
Side blind spot alert ⇒ page 123

Electric Adjustment

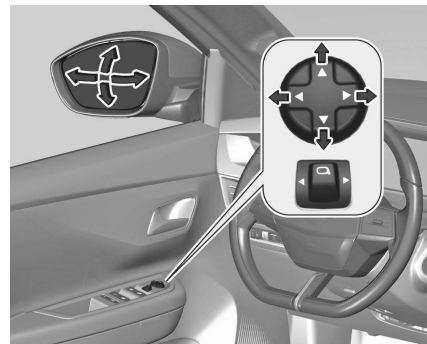

Select the relevant exterior mirror by moving the switch to the left or right.

Then use the 4-way control to adjust the mirror.

Folding Mirrors

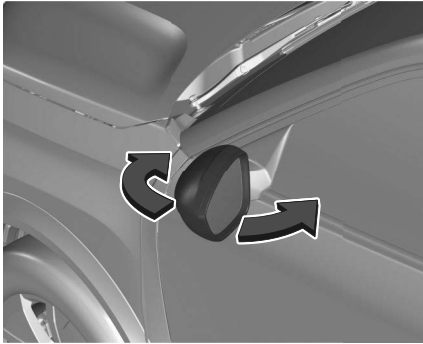

For pedestrian safety, the exterior mirrors will swing out of their normal mounting position if they are struck with sufficient force. Reposition the mirror by applying slight pressure to the mirror housing.

Manual Electric Folding

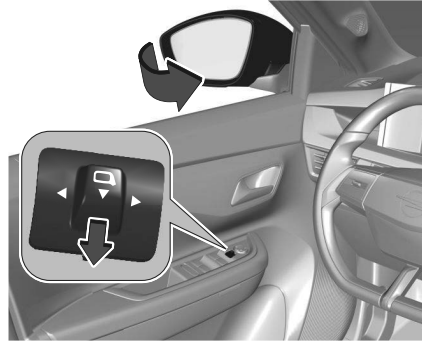

Move the switch to the centre position. Pull it rearwards. Both exterior mirrors are folded.

Pull it rearwards again. Both exterior mirrors return to their original position. If an electrically folded mirror is manually unfolded, pulling the switch rearwards will only unfold the other mirror electrically.

Automatic Electric Folding

When the vehicle is unlocked, the mirrors swing to their normal mounting position. When the vehicle is locked, the mirrors are folded down.

To enable or disable automatic folding of the exterior mirrors, consult a workshop.

Heated Mirrors



Press  to activate the heating of the exterior mirrors.

The LED in the button illuminates to indicate activation. Press  again to switch off the function.

The heating switches off automatically after a certain time depending on the outside temperature.

When the ignition is switched off, the function is deactivated.

Depending on climate control system, the button can be located at a different position.

Heated rear window ⇒ page 15.

Interior Mirrors

Interior Mirror Adjustment

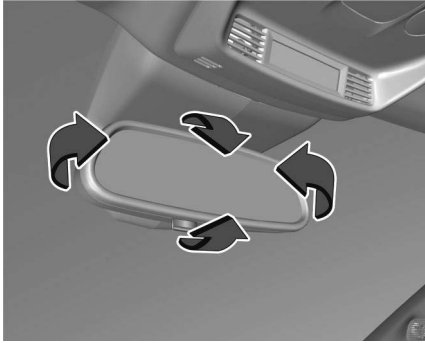

To adjust the mirror, move the mirror housing in the desired direction.

Manual Anti-Dazzle

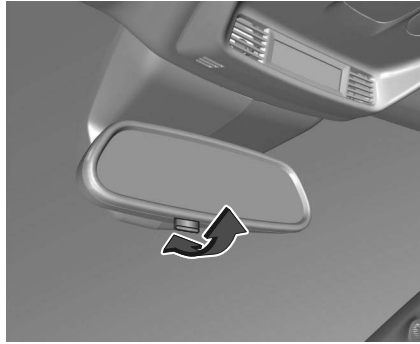

To reduce dazzle, pull the lever on the underside of the mirror housing.

Automatic Anti-Dazzle



Dazzle from following vehicles is automatically reduced, when driving in the dark.

Windows

Windscreen

Windscreen Stickers



Do not attach stickers such as toll road stickers or similar on the windscreen in the area of the interior mirror. Keep the sensor free from dust, dirt and ice. Otherwise, the detection zone of the rain sensor / light sensor and the view area of the camera in the mirror housing could be restricted.



Windscreen Replacement

Caution

If the vehicle has a front-looking camera sensor for the driver assistance systems, it is very important that any windscreen replacement is performed accurately according to Opel specifications. Otherwise, these systems may not work properly and there is a risk of unexpected behaviour and / or messages from these systems.

Heated Windscreen



Press  to activate the function. The LED in the button illuminates to indicate activation. Press  again to switch off the function.

The heating works only with freezing outside temperatures and switches off automatically after a certain time depending on the outside temperature. When the ignition is switched off, the function is deactivated. Depending on the climate control system, this button can be located at a different position.



Power Windows

Warning

Take care when operating the power windows. Risk of injury, particularly to children. If there are children on the rear seats, switch on the child safety system for the power windows. Keep a close watch on the windows when closing them. Ensure that nothing becomes trapped in them as they move.

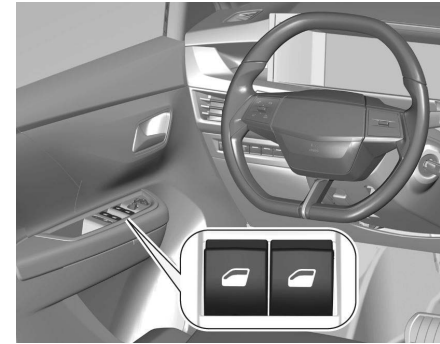
Switch on the ignition to operate the power windows.



Operate  for the respective window by pushing to open or pulling to close. Long pushing or pulling: the window moves up or down completely when the switch is released. Short pushing or pulling: the window moves up or down as long as  is operated.

Safety Function

Depending on version, on driver side only: if the window glass encounters resistance above the middle of the window during automatic closing, it is immediately stopped and opened again.

Override Safety Function

In the event of closing difficulties due to frost or the like, switch on the ignition,

then pull the switch to the first detent and hold. The window moves up without safety function enabled.

To stop movement, release the switch.

Child Safety System For Rear Windows



Press the button to deactivate the rear door power windows; the LED illuminates. To activate, press again.

Operating Windows From Outside

The windows can be operated remotely from outside the vehicle.

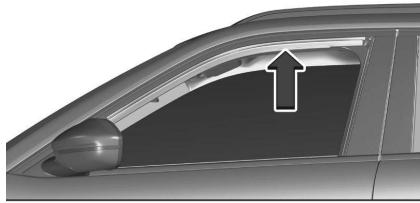

Press and hold  to close the windows. Release the button to stop window movement.

If the windows are fully closed, the hazard warning lights will flash twice.

Overload

If the windows are repeatedly operated within short intervals, the window operation is disabled for some time.

Initialising The Power Windows

If the windows cannot be closed automatically (e.g. after disconnecting the vehicle battery), a warning message is displayed on the cluster

Activate the window electronics as follows:

1. Close the doors.

2. Switch on the ignition.
3. Pull the switch until the window is closed and keep pulling for additional two seconds.
4. Push the switch until the window is completely open and keep pushing for additional two seconds.
5. Repeat for each window.

Fault

In some circumstances, the power windows will be opened repeatedly or may not operate correctly.

Proceed as follows:



1. Close the doors.
2. Switch on the ignition.
3. Pull the switch three times in less than ten seconds to trigger the safety function.
4. The safety function is not active anymore. Pull the switch a fourth time until the window is completely closed.

Manual Windows

The rear door windows can be opened or closed manually with the window cranks.

Heated Rear Window



Press  to activate the function. The LED in the button illuminates to indicate activation. Press  again to switch off the function. The heating switches off automatically after a certain time depending on the outside temperature. When the ignition is switched off, the function is deactivated. Depending on climate control system, the button can be located at a different position. Heated exterior mirrors ⇨ page 11

Sun Visors

The sun visors can be folded down or swivelled to the side to prevent dazzling.

If the sun visors have integral mirrors, the mirror covers should be closed when driving. A ticket holder is located on the backside of the sun visor.

Seats, Restraints

| | |
|--|----|
| Head Restraints..... | 16 |
| Head Restraint Position..... | 16 |
| Front Head Restraints..... | 16 |
| Rear Head Restraints..... | 17 |
| Refitting A Head Restraint..... | 17 |
| Front Seats..... | 17 |
| Seat Position..... | 17 |
| Manual Seat Adjustment..... | 18 |
| Heated Seats..... | 19 |
| Rear Seats..... | 19 |
| Folding The Backrest Second Row..... | 19 |
| Folding The Backrest Third Row..... | 19 |
| Repositioning The Backrest..... | 19 |
| Seat Belts..... | 20 |
| Seat Belt Reminder..... | 20 |
| Belt Force Limiters..... | 20 |
| Belt Pretensioners..... | 20 |
| Three-Point Seat Belt..... | 21 |
| Airbag System..... | 22 |
| Child Restraint Systems On Front Passenger Seat With Airbag Systems..... | 22 |
| Front Airbag System..... | 24 |
| Side Airbag System..... | 25 |
| Curtain Airbag System..... | 25 |
| Airbag Deactivation..... | 25 |
| Child Restraints..... | 26 |
| Child Restraint Systems..... | 26 |
| Selecting The Right System..... | 28 |

| | |
|---|----|
| Child Restraint Installation Locations..... | 30 |
|---|----|

Head Restraints

Head Restraint Position



Warning

Only drive with the head restraint set to the proper position.

The upper edge of the head restraint should be at upper head level. If this is not possible for extremely tall people, set to highest position, and set to lowest position for small people.

Front Head Restraints

Height Adjustment

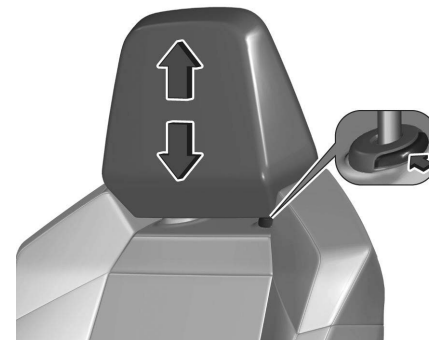

Press release button, adjust height, engage.

Rear Head Restraints

Height Adjustment

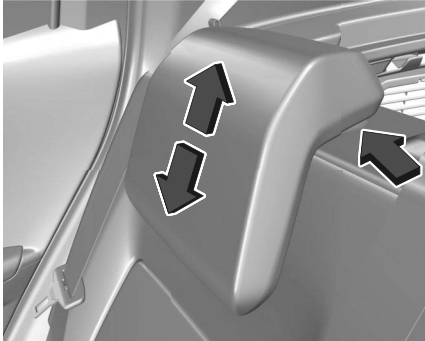

Pull the head restraint upwards or press the catch to release and push the head restraint downwards.

Remove

E.g. when using a child restraint system
⇒ page 26.

Pull the head restraint upwards, press the catch to release and pull the head restraint out.

Refitting A Head Restraint

- Insert the head restraint rods into the guides in the corresponding seat backrest.
- Push the head restraint fully down.
- Adjust the height of the head restraint.

Front Seats

Seat Position

⚠ Warning

Only drive with the seat correctly adjusted.

⚠ Danger

Do not sit closer than 25 cm to the steering wheel, to permit safe airbag deployment.

⚠ Warning

Never adjust seats while driving as they could move uncontrollably.

⚠ Warning

Never store any objects under the seats.



- Sit with buttocks as far back against the backrest as possible. Adjust the distance between the seat and the pedals so that legs are slightly angled when fully pressing the pedals. Slide the front passenger seat as far back as possible.
- Set the seat height high enough to have a clear field of vision on all sides and on instrument cluster. There should be at least one hand of clearance between head and the roof frame. Thighs should rest lightly on the seat without pressing into it.

- Sit with shoulders as far back against the backrest as possible. Set the backrest rake so that it is possible to easily reach the steering wheel with arms slightly bent. Maintain contact between shoulders and the backrest when turning the steering wheel. Do not angle the backrest too far back. We recommend a maximum rake of approx. 25°.
- Adjust the seat and the steering wheel in a way that the wrist rests on top of the steering wheel while the arm is fully extended and shoulders are on the backrest.
- Adjust the steering wheel ⇔.
- Adjust the head restraint ⇔ page 16.
- Adjust the thigh support so that there is a space approx. two fingers wide between the edge of the seat and the hollow of the knee.
- Adjust the lumbar support so that it supports the natural shape of the spine.

Manual Seat Adjustment

Drive only with engaged seats and backrests.

Longitudinal Adjustment



Pull handle, slide seat, release handle. Try to move the seat back and forth to ensure that the seat is locked in place.

Backrest Inclination

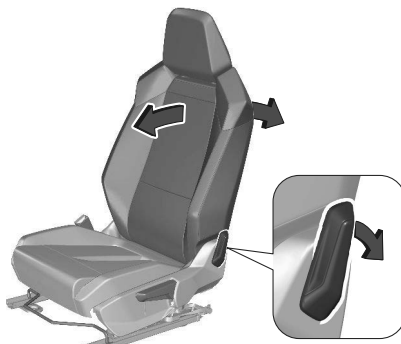

Push the lever backwards. Lean on the backrest to obtain the desired angle.

Seat Height

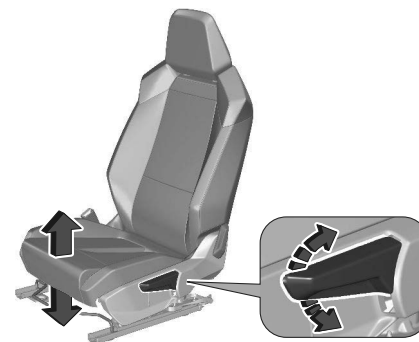

Lever pumping motion

| | |
|-------------|-------------|
| up | seat higher |
| down | seat lower |

Heated Seats



Adjust the heating to the desired setting by pressing the button for the respective seat one or more times. The control indicator in the button indicates the setting.

The heating works only when the outside temperature is below 20 °C.

Prolonged use of the highest setting for people with sensitive skin is not recommended.

Seat heating is operational when the engine is running.

During an Autostop, seat heating is also operational.

Rear Seats

Drive only with engaged seats and backrests.

Warning

Never adjust seats while driving as they could move uncontrollably.

Folding The Backrest Second Row

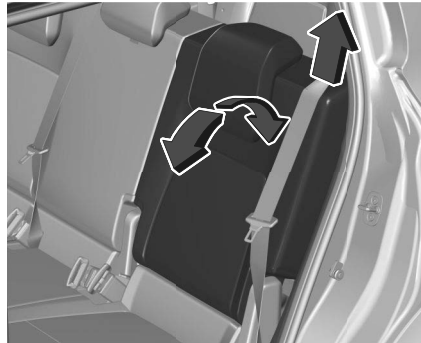

Pull the loop, adjust inclination and release the loop. Do not lean on the backrest when adjusting.

Folding The Backrest Third Row

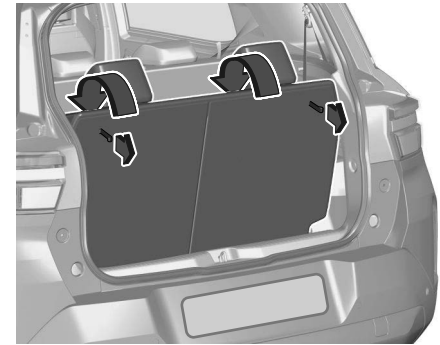

Pull the loop, adjust inclination and release the loop. Do not lean on the backrest when adjusting.

Repositioning The Backrest

Warning

First check that the outer seat belts are lying vertically flat alongside the backrest latching rings.

- Put the backrest in the upright position and push it firmly to latch it home.
- Check that the release strap has correctly returned to its position.

- Ensure that the outer seat belts were not trapped during the operation.

⚠ Warning

Please note: an incorrectly latched backrest compromises the safety of passengers in the event of sudden braking or an accident.

The contents of the boot may be thrown forwards - risk of serious injury!

Seat Belts



The seat belts are locked during heavy acceleration or deceleration of the vehicle, holding the occupants in the seat position. Therefore the risk of injury is considerably reduced.

⚠ Warning

Fasten seat belt before each trip. In the event of an accident, people not wearing seat belts endanger their fellow occupants and themselves.

Seat belts are designed to be used by only one person at a time.

Child restraint system ⇨ page 26

Periodically check all parts of the seat belt system for damage, soiling and proper functionality.

Have damaged components replaced.

After an accident, have the seat belts and triggered seat belt pretensioners replaced by a workshop.

Note

Make sure that the seat belts are neither damaged by shoes or sharp-edged objects nor trapped. Prevent dirt from getting into the seat belt retractors.

Note

Use the belt buckle intended for the respective seat belt when fastening in order to ensure proper functionality.

Seat Belt Reminder

Each seat is equipped with a seat belt reminder, indicated by a control indicator for the respective seat in the overhead console.

Seat belt reminder ⇨ page 47

Belt Force Limiters

Stress on the body is reduced by the gradual release of the seat belt during a collision.

Belt Pretensioners

In the event of a head-on, rear-end or side-on collision of a certain severity, the front seat belts and the outer rear seat belts are tightened by seat belt pretensioners.

⚠ Warning

Incorrect handling (e.g. removal or fitting of seat belts) can trigger the belt pretensioners.

The deployment of the belt pretensioners is indicated by continuous illumination of the control indicator.

Airbag and belt pretensioners ⇨ page 20

Triggered belt pretensioners must be replaced by a workshop. Belt pretensioners can only be triggered once.

Note

Do not affix or install accessories or other objects that may interfere with the operation of the belt pretensioners. Do not make any modifications to belt pretensioner components as this will invalidate the vehicle operating permit.

Three-Point Seat Belt

Fasten

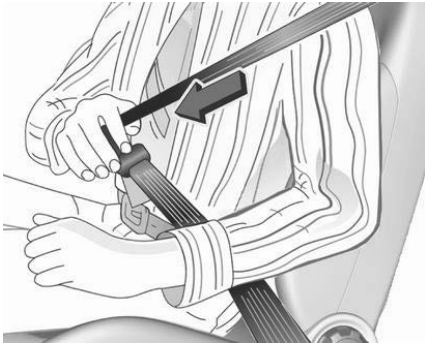

Withdraw the seat belt from the retractor, guide it untwisted across the body and insert the latch plate into the buckle. Make sure the seat belt lies across the shoulder and fits tightly to the body while driving.

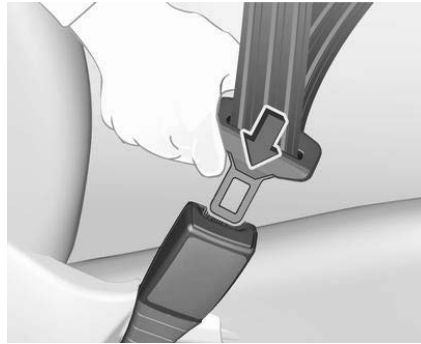

Loose or bulky clothing prevents the seat belt from fitting snugly. Do not place objects such as handbags or mobile phones between the seat belt and your body.

Warning

The seat belt must not rest against hard or fragile objects in the pockets of your clothing.

Seat belt reminder ⇒ page 47

Unfasten

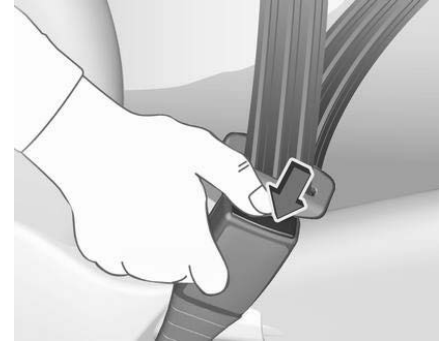

To release seat belt, press red button on seat belt buckle and guide the seat belt back.

Using The Seat Belt While Pregnant



⚠ Warning

The lap seat belt must be positioned as low as possible across the pelvis to prevent pressure on the abdomen.

Airbag System

The airbag system consists of a number of individual systems depending on the scope of equipment.

When triggered, the airbags inflate within milliseconds. They also deflate so quickly that it is often unnoticeable during the collision.

⚠ Warning

The airbag system deploys in an explosive manner, repairs must be performed by skilled personnel only.

⚠ Warning

Adding accessories that change the vehicle frame, bumper system, height, front end or side sheet metal, may keep the airbag system from working properly. The operation of the airbag system can also be affected by changing any parts of the front seats, seat belts, airbag sensing and

diagnostic module, steering wheel, instrument panel, inner door seals including the speakers, any of the airbag modules, ceiling or pillar trim, front sensors, side impact sensors or airbag wiring.

⚠ Warning

Keep the area in which the airbag inflates clear of obstructions.

Note

The airbag systems and belt pretensioner control electronics are located in the centre console. Do not put any magnetic objects in this area.

Do not affix any objects onto the airbag covers and do not cover them with other materials. Have damaged covers replaced by a workshop.

Each airbag is triggered only once.

Have deployed airbags replaced by a workshop. Furthermore, it may be necessary to have the steering wheel, the instrument panel, parts of the panelling, the door seals, handles and the seats replaced.

Do not make any modifications to the airbag system as this will invalidate the vehicle operating permit.

Control indicator for airbag systems ⇨ page 47

Child Restraint Systems On Front Passenger Seat With Airbag Systems



EN: NEVER use a rearward-facing child restraint on a seat protected by an ACTIVE AIRBAG in front of it; DEATH or SERIOUS INJURY to the CHILD can occur.

DE: Nach hinten gerichtete Kindersitze NIEMALS auf einem Sitz verwenden, der durch einen davor befindlichen AKTIVEN AIRBAG geschützt ist, da dies den TOD oder SCHWERE VERLETZUNGEN DES KINDES zur Folge haben kann.

FR: NE JAMAIS utiliser un siège d'enfant orienté vers l'arrière sur un siège protégé par un COUSSIN GONFLABLE ACTIF placé devant lui, sous peine

d'infliger des BLESSURES GRAVES, voire MORTELLES à l'ENFANT.

ES: NUNCA utilice un sistema de retención infantil orientado hacia atrás en un asiento protegido por un AIRBAG FRONTAL ACTIVO. Peligro de MUERTE o LESIONES GRAVES para el NIÑO.

RU: ЗАПРЕЩАЕТСЯ устанавливать детское удерживающее устройство лицом назад на сиденье автомобиля, оборудованном фронтальной подушкой безопасности, если ПОДУШКА НЕ ОТКЛЮЧЕНА! Это может привести к СМЕРТИ или СЕРЬЕЗНЫМ ТРАВМАМ РЕБЕНКА.

NL: Gebruik NOOIT een achterwaarts gericht kinderzitje op een stoel met een ACTIEVE AIRBAG ervoor, om DODELIJK of ERNSTIG LETSEL van het KIND te voorkomen.

DA: Brug ALDRIG en bagudvendt autostol på et forsæde med AKTIV AIRBAG. BARNET kan komme i LIVSFARE eller komme ALVORLIGT TIL SKADE.

SV: Använd ALDRIG en bakåtvänd barnstol på ett säte som skyddas med en framförvarande AKTIV AIRBAG. DÖDSFALL eller ALLVARLIGA SKADOR kan drabba BARNET.

FI: ÄLÄ KOSKAAN sijoita taaksepäin suunnattua lasten turvaistuinta istuimelle, jonka edessä on AKTIIVINEN

TURVATYYNY, LAPSI VOI KUOLLA tai VAMMAUTUA VAKAVASTI.

NO: Bakovervendt barnesikringsutstyr må ALDRI brukes på et sete med AKTIV KOLLISJONSPUTE foran, da det kan føre til at BARNET utsettes for LIVSFARE og fare for ALVORLIGE SKADER.

PT: NUNCA use um sistema de retenção para crianças voltado para trás num banco protegido com um AIRBAG ACTIVO na frente do mesmo, poderá ocorrer a PERDA DE VIDA ou FERIMENTOS GRAVES na CRIANÇA.

IT: Non usare mai un sistema di sicurezza per bambini rivolto all'indietro su un sedile protetto da AIRBAG ATTIVO di fronte ad esso: pericolo di MORTE o LESIONI GRAVI per il BAMBINO!

EL: ΠΟΤΕ μη χρησιμοποιείτε παιδικό κάθισμα ασφαλείας με φορά προς τα πίσω σε κάθισμα που προστατεύεται από μετωπικό ΕΝΕΡΓΟ ΑΕΡΟΣΑΚΟ, διότι το παιδί μπορεί να υποστεί ΘΑΝΑΣΙΜΟ ή ΣΟΒΑΡΟ ΤΡΑΥΜΑΤΙΣΜΟ.

PL: NIE WOLNO montować fotelika dziecięcego zwróconego tyłem do kierunku jazdy na fotelu, przed którym znajduje się WŁĄCZONA PODUSZKA POWIETRZNA.

Niezastosowanie się do tego zalecenia może być przyczyną ŚMIERCI lub POWAŻNYCH OBRAŻEŃ u DZIECKA.

TR: Arkaya bakan bir çocuk emniyet sistemini KESİNLİKLE önünde bir AKTİF HAVA YASTIĞI ile korunmakta olan bir koltukta kullanmayınız. ÇOCUK ÖLEBİLİR veya AĞIR ŞEKİLDE YARALANABİLİR.

UK: НІКОЛИ не використовуйте систему безпеки для дітей, що встановлюється обличчям назад, на сидінні з УВІМКНЕНОЮ ПОДУШКОЮ БЕЗПЕКИ, інакше це може призвести до СМЕРТІ чи СЕРЬОЗНОГО ТРАВМУВАННЯ ДИТИНИ.

HU: SOHA ne használjon hátrafelé néző biztonsági gyereklést előlről AKTÍV LÉGZSÁKKAL védett ülésen, mert a GYERMEK HALÁLÁT vagy KOMOLY SÉRÜLÉSÉT okozhatja.

HR: NIKADA nemojte koristiti sustav zadržavanja za djecu okrenut prema natrag na sjedalu s AKTIVNIM ZRAČNIM JASTUKOM ispred njega, to bi moglo dovesti do SMRTI ili OZBILJNJIH OZLJEDA za DIJETE.

SL: NIKOLI ne nameščajte otroškega varnostnega sedeža, obrnjenega v nasprotni smeri vožnje, na sedež z AKTIVNO ČELNO ZRAČNO BLAZINO, saj pri tem obstaja nevarnost RESNIH ali SMRTNIH POŠKODB za OTROKA.

SR: NIKADA ne koristiti bezbednosni sistem za decu u kome su deca okrenuta unazad na sedištu sa AKTIVNIM

VAZDUŠNIM JASTUKOM ispred sedišta zato što DEJE može da NASTRADA ili da se TEŠKO POVREDI.

MK: НИКОГАШ не користете детско седиште свртено наназад на седиште заштитено со АКТИВНО ВОЗДУШНО ПЕРНИЧЕ пред него, затоа што детето може ДА ЗАГИНЕ или да биде ТЕШКО ПОВРЕДЕНО.

BG: НИКОГА не използвайте детска седалка, гледаща назад, върху седалка, която е защитена чрез АКТИВНА ВЪЗДУШНА ВЪЗГЛАВНИЦА пред нея - може да се стигне до СМЪРТ или СЕРИОЗНО НАРАНЯВАНЕ на ДЕТЕТО.

RO: Nu utilizați NICIODATĂ un scaun pentru copil îndreptat spre partea din spate a mașinii pe un scaun protejat de un AIRBAG ACTIV în fața sa; acest lucru poate duce la DECESUL sau VĂTĂMAREA GRAVĂ a COPILULUI.

CS: NIKDY nepoužívejte dětský zádržný systém instalovaný proti směru jízdy na sedadle, které je chráněno před sedadlem AKTIVNÍM AIRBAGEM. Mohlo by dojít k VÁŽNĚMU PORANĚNÍ nebo ÚMRTÍ DÍTĚTE.

SK: NIKDY nepoužívajte detskú sedačku otočenú vzad na sedadle chránenom AKTÍVNÝM AIRBAGOM, pretože môže dôjsť k SMRTI alebo VÁŽNYM ZRANENIAM DIEŤAŤA.

LT: JOKIU BŪDU nemontuokite atgal atgręžtos vaiko tvirtinimo sistemas sėdynėje, prieš kurią įrengta AKTYVI ORO PAGALVĖ, nes VAIKAS GALI ŽŪTI arba RIMTAI SUSIŽALOTI.

LV: NEKĀDĀ GADĪJUMĀ neizmantojiet uz aizmuguri vērstu bērnu sēdekļīti sēdvietā, kas tiek aizsargāta ar tās priekšā uzstādītu AKTĪVU DROŠĪBAS SPILVENU, jo pretējā gadījumā BĒRNS var gūt SMAGAS TRAUMAS vai IET BOJĀ.

ET: ÄRGE kasutage tahapoole suunatud lapseturvaistet istmel, mille ees on AKTIIVSE TURVAPADJAGA kaitstud iste, sest see võib põhjustada LAPSE SURMA või TÕSISE VIGASTUSE.

MT: QATT tuża trażżin għat-ffal li jġares lejn in-naħa ta' wara fuq sit protett b'AIRBAG ATTIV quddiemu; dan jista' jikkawża l-MEWT jew ĠRIEHI SERJI lit-TFAL.

GA: Ná húsáid srian sábháilteachta linbh cúil RIAMH ar shuíochán a bhfuil mála aeir ag feidhmiú os a chomhair. Tá baol BÁIS nó GORTÚ DONA don PHÁISTE ag baint leis.

Additionally, for safety reasons a forward-facing child restraint system must only be used subject to the instructions and restrictions in the table ⇒ page 26.

The airbag label is located on both sides of the front passenger sun visor.

Airbag deactivation ⇒ page 25

Front Airbag System

The front airbag system consists of one airbag in the steering wheel and one on the cluster on the front passenger side. These can be identified by the word **AIRBAG**.

The front airbag system is triggered in the event of a front-end impact of a certain severity. The ignition must be switched on.

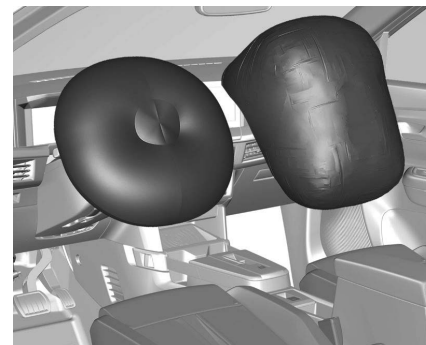

The inflated airbags cushion the impact, thereby reducing the risk of injury to the upper body and head of the front seat occupants considerably.

⚠ Warning

Optimum protection is only provided when the seat is in the proper position. Seat position ⇒ page 17
Keep the area in which the airbag inflates clear of obstructions. Fit the seat belt correctly and engage securely. Only then is the airbag able to protect.

Side Airbag System

The side airbag system consists of an airbag in each front seat backrest.

This can be identified by the word **AIRBAG**.

The side airbag system is triggered in the event of a side impact of a certain severity. The ignition must be switched on.



The inflated airbags cushion the impact, thereby reducing the risk of injury to the upper body and pelvis in the event of a side-on collision considerably.

Note

Only use protective seat covers that have been approved for the vehicle. Be careful not to cover the airbags.

Curtain Airbag System

The curtain airbag system consists of an airbag in the roof frame on each side. This can be identified by the word **AIRBAG** on the roof pillars.

The curtain airbag system is triggered in the event of a side-on impact of a certain severity. The ignition must be switched on.

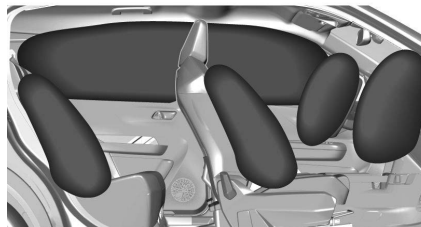

The inflated airbags cushion the impact, thereby reducing the risk of injury to the head in the event of a side-on impact considerably.

⚠ Warning

The hooks on the handles in the roof frame are only suitable for hanging up light articles of clothing, without coat hangers. Do not keep any items in these clothes.

Airbag Deactivation

The front passenger airbag system must be deactivated for child restraint system on the passenger seat according to the instructions in the table.

The side airbag and curtain airbag systems, the belt pretensioners and all driver airbag systems will remain active. The front passenger airbag system can be deactivated via a keyoperated switch on the passenger side of the cluster. Child Restraint Installation Locations ⇒ page 30



Use the ignition key to choose the position:

OFF  front passenger airbag is deactivated and will not inflate in the event of a collision. Control indicator illuminates continuously in the centre console

ON  front passenger airbag is active

Danger

Deactivate the passenger airbag only in combination with the use of a child restraint system, subject to the instructions and restrictions in the Child Restraints table.

Otherwise, there is a risk of fatal injury for a person occupying a seat with a deactivated front passenger airbag.



If the control indicator ON illuminates for approx. 60 seconds after the ignition is switched on, the front passenger airbag system will inflate in the event of a collision.

If the control indicator OFF illuminates after the ignition is switched on, the front passenger airbag system is deactivated. It stays on while the airbag is deactivated.

If both control indicators are illuminated at the same time, there is a system failure. The status of the system is not discernible, therefore no person is allowed to occupy the front passenger seat. Contact a workshop immediately.

Consult a workshop immediately if neither of the two control indicators are illuminated.

Change status only when the vehicle is stopped with the ignition off.

Control indicator for airbag deactivation
⇒ page 48.

Child Restraints

Child Restraint Systems

Danger

Make sure that children below sufficient size and weight are protected using a suitable child restraint system. Never place a child on the lap.

Danger

If using a rear-facing child restraint system on the front passenger seat, the airbag system for the front passenger seat must be deactivated. This also applies to certain forward-facing child restraint systems as indicated in the Child Restraints table.

Airbag deactivation ⇒ page 25

Airbag label ⇒ page 22

We recommend a child restraint system which is tailored specifically to the vehicle. For further information, contact your workshop.

In case of any interference of the child restraint system with the vehicle seat head restraint, adjust or remove the corresponding head restraint ⇒ page 16. When a child restraint system is being used, pay attention to the following usage and installation instructions and also those supplied with the child restraint system. The given restrictions in the table refer to a test body, which is the maximum envelope of all existing child restraint systems. Make sure that the front seats do not interfere with the used child restraint system.

Always comply with local or national regulations. In some countries, the use of child restraint systems is forbidden on certain seats.

Only drive with the driver seat correctly adjusted ⇒ page 17.

⚠ Danger

Extreme Hazard!
Do not use a rearward facing child restraint on a seat protected by an airbag in front of it.

Child restraint systems can be fastened with:

- Three-point seat belt
- ISOFIX brackets
- Top-tether anchors

Three-Point Seat Belt

Child restraint systems can be fastened by using a three-point seat belt. After fastening the child restraint system the seat belt has to be tightened ⇒ page 30.

"ISOFIX" Brackets



Fasten vehicle-approved ISOFIX child restraint systems to the ISOFIX brackets. Specific vehicle ISOFIX child restraint

system positions are marked in the child restraints table.

ISOFIX brackets are indicated by a label on the backrest. To get access to the ISOFIX brackets, first pull the zipper. An i-Size child restraint system is an universal ISOFIX child restraint system according to UN Regulation No. 129. All i-Size child restraint systems can be used on any vehicle seat suitable for i-Size, child restraint installation table ⇒ page 30.

When fastening ISOFIX child restraint systems on adjustable passenger seats, first incline the backrest as far as necessary backwards in order to get access to the ISOFIX brackets.

After the proper fastening of the ISOFIX child restraint system, incline the backrest forward again.

Either a Top-tether strap or a support leg must be used in addition to the ISOFIX brackets.

i-Size child seats and vehicle seats with i-Size approval are marked with i-Size symbol, see illustration.



Top-Tether Anchors



Top-tether anchors are marked with a symbol for child seat.

In addition to the ISOFIX brackets, fasten the Top-tether strap to the Top-tether anchors.

ISOFIX child restraint systems of universal category positions are marked in the table. → page 30

Selecting The Right System

The rear seats are the most convenient location to fasten a child restraint system. Children should travel facing rearwards in the vehicle as long as possible. This makes sure that the child's backbone, which is still very weak, is under less strain in the event of an accident.

Do not use forward facing child restraint system at all seats when child's weight is below 13 kg or child's size is less than 76 cm and up to the age of 15 months.

Suitable are child restraint systems that comply with valid UN ECE regulations. Check local laws and regulations for mandatory use of child restraint systems. The following child restraints are recommended for the following weight classes:

- Römer Baby-Safe 3 i-Size
Size: 40 - 83 cm
Age: from birth to 15 months
Weight: up to 13 kg
Recommended with its ISOFIX base.
Suitable for rearward facing installation only.
- RömerTriFix 2 i-Size
Size: 76 - 105 cm
Age: from 15 months to 4 years
Weight: from 9 to 22 kg
Installed with ISOFIX and Top-tether mountings.
Suitable for forward facing installation only.
- Römer Kidfix i-Size
Size: 100 - 150 cm
Age: from 3.5 to 12 years
Weight: from 15 to 36 kg
with or without ISOFIX mountings
The child is restrained by the seat belt.

Bought in Stellantis & You, Sales and Services.

We recommend using the child seat with the backrest.

If the backrest is removed for a child over 138 cm, the secure guard must also be removed.

Ensure that the child restraint system to be installed is compatible with the vehicle type.

Child seat at the front: Adjust the front passenger seat to the highest and fully back longitudinal position with the backrest straightened.

Child seat at the rear: Move the vehicle's front seat forward and straighten the backrest so that the legs of the child in the forward facing or the rearward facing child seat do not touch the vehicle's front seat.

In case of any interference of the child restraint system with the vehicle seat head rest, adjust or remove the corresponding vehicle seat head rest. Please follow the child restraint manufacturers instructions to install the corresponding child restraints in the vehicle.

For semi-universal or vehicle specific child restraint system (ISOFIX or belted child restraint system), see the vehicle list provided in the user manual of the child restraint system.

Ensure that the mounting location of the child restraint system within the vehicle is correct, see following table.

Allow children to enter and exit the vehicle only on the side facing away from the traffic.

When the child restraint system is not in use, secure the seat with a seat belt or remove it from the vehicle.

Note

Do not affix anything on the child restraint systems and do not cover them with any other materials. A child restraint system which has been subjected to stress in an accident must be replaced.

Child Restraint Installation Locations

5 Seaters

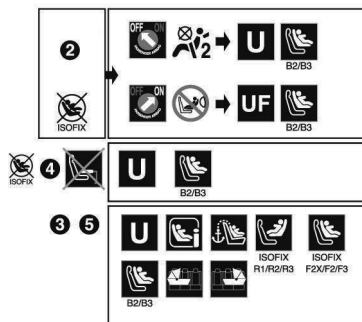
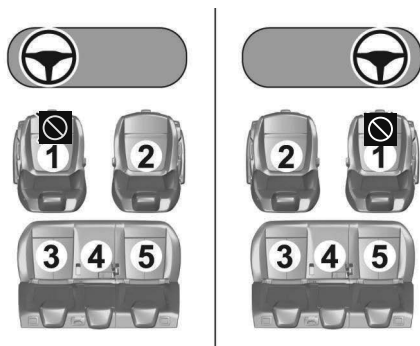

7 Seaters

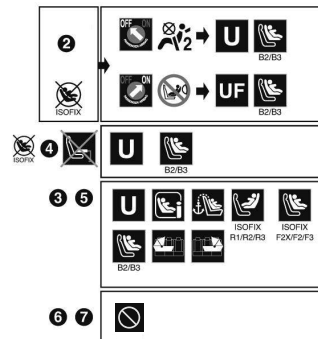
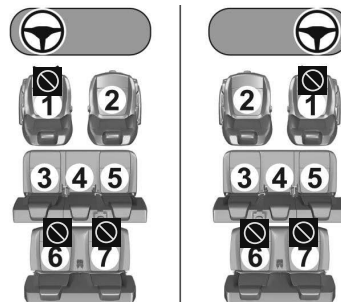

Key



Seat position where the installation of a child seat is forbidden.



Front passenger airbag **deactivated**.



Front passenger airbag **activated**.



Seat position suitable for the installation of a child seat secured using the seat belt and universally approved "**rearward facing**" and/or "**forward facing**" (U) for groups **0, 0+, 1, 2** or **3** or dedicated to children between 40 to 150 cm in size.



Seat position suitable for the installation of a child seat secured using the seat belt and **universally approved "forward facing"** (UF) for groups **1, 2** and **3**, or dedicated to children between 76 and 150 cm in size only.



Seat position authorised for the installation of an **i-Size** child seat.



Seat position not suitable for the installation of a child seat with support leg.



Presence of a **Top Tether** anchorage point at the rear of the backrest, authorising the installation of an **universal ISOFIX child seat**.



"Rearward facing" **ISOFIX** child seat:

- **R1: ISOFIX** child seat for a **baby**
- **R2: ISOFIX reduced size** child seat.
- **R3: ISOFIX** large size child seat



"Forward facing" **ISOFIX** child seat:

- **F2X: ISOFIX** child seat **for toddlers**.
- **F2: ISOFIX reduced height** child seat.

- **F3: ISOFIX full height** child seat.



Booster child seat, using seat belt or **ISOFIX** mountings:

- **B2: reduced width booster seat.**
- **B3: full width booster seat.**



Seat position where the installation of an **ISOFIX** child seat is forbidden.

For seat adjustments, refer to the summary table "**Installing universal, ISOFIX and i-Size child seats**".



ISOFIX "carrycot" type child seat:

- **L1** : left-hand facing.
- **L2** : right-hand facing.

As required by European regulations, this table gives the options for installing child seats secured using the seat belt and universally approved as well as the larger ISOFIX and i-Size child seats on seat positions equipped with ISOFIX mountings in the vehicle.

Yes : Suitable for fitment of the designated category of the child restraint system.

No : Not suitable for fitment of the designated category of the child restraint system.

Summary table for installation of universal, ISOFIX and i-Size child seats

| | Seat numbers | | | | | | | |
|---|----------------------------|-------------------------------------|----------------------------------|-----|--------------------|---------------------------------|----|----|
| | Front seats ^(b) | | Rear seats ^(b) row 2 | | | Rear seats ^(b) row 3 | | |
| | 1 | 2 | 3 | 4 | 5 | 6 | 7 | |
| Front passenger airbag | | Deactivated "OFF" ^(c) | Activated "ON" ^(d) | | | | | |
| Position compatible with a universal ^(a) child seat Rearward Facing ^(e) | no | yes ^(h) | no | yes | yes ⁽ⁱ⁾ | yes | no | no |
| Position compatible with a universal ^(a) child seat Forward Facing ^(f) | no | yes ^(h) | | yes | yes ⁽ⁱ⁾ | yes | no | no |
| Position compatible with an i-Size child seat Rearward Facing | no | no | yes | no | yes | no | no | no |
| Position compatible with an i-Size child seat Forward Facing | no | no | yes | no | yes | no | no | no |
| Position compatible with a TOP TETHER hook | no | no | yes | no | yes | no | no | no |
| " Carrycot " type of child seat (L1 / L2) | no | no | L2 ^(g) | no | L1 ^(g) | no | no | no |
| " Rearward facing " ISOFIX child seat (R1/R2/R3) | no | no | R3 ^(k) | no | R3 ^(k) | no | no | no |
| " Forward facing " ISOFIX child seat (F1/F2X/F3) | no | no | F3 ^(k) | no | F3 ^(k) | no | no | no |

| | Seat numbers | | | | | | |
|--|----------------------------|-------------------------------|---------------------------------|----------------------------------|-------------------|---------------------------------|----|
| | Front seats ^(b) | | Rear seats ^(b) row 2 | | | Rear seats ^(b) row 3 | |
| | 1 | 2 | 3 | 4 | 5 | 6 | 7 |
| "Booster" child seat (B2 / B3) ⁽ⁿ⁾ | no | B3 ^(h) (l) (k) (m) | B3 ^(k) | B3 ^(l) (j) (l) (k) | B3 ^(k) | no | no |

- (a) Universal child seat: child seat that can be installed in all vehicles using the seat belt.
- (b) Depending on version, refer to the legislation in force in your country before installing a child in this seat position.
- (c) To install a **"rearward facing"** child seat at this seat position, the front passenger airbag **MUST** be deactivated **"OFF"**.
- (d) Only a **"forward facing"** child seat is authorized at this seat position with the front passenger airbag activated **"ON"**.
- (e) For a **"rearward facing"** and/or **"forward facing"** universal child seat (U) for groups **0, 0+, 1, 2** or **3** or dedicated to children between 40 cm and 150 cm in height.
- (f) For a **"forward facing"** universal child seat (UF) in groups **1, 2** or **3**, or dedicated to children between 76 cm and 150 cm in height only.
- (g) If a lateral facing child restraint system is installed on the outer seat of the second row the use of the other seating positions in this row is excluded.
- (h) Adjust the front passenger seat to the fully rearward longitudinal position.
- (i) A child seat with a support leg must never be installed on the centre rear passenger seat.
- (j) If a booster child restraint system is installed on the center seat the left seating position **4** must not be occupied.
- (k) Adjust the headrest to the maximum height position or remove it if necessary.
- (l) Seats not fitted with ISOFIX compliant mountings.

-
- (m) For seats with integrated head restraint: in case of interference between child seat and integrated head restraint adjust the seat backrest to a less upright position.
- (n) It is not possible to install 3 booster child seats on the rear seats at the same time.

Rules:

- A position that is i-Size compatible is also compatible for R1, R2 and F2X, F2, B2.
- A position that is R3 compatible is also compatible for R1 and R2.
- A position that is R2 compatible is also compatible for R1.
- A position that is F3 compatible is also compatible for F2X and F2.
- A position that is B3 compatible is also compatible for B2.

Storage

| | |
|-------------------------------|----|
| Storage Compartments..... | 36 |
| Glove Box..... | 36 |
| Cupholders..... | 36 |
| Front Storage..... | 36 |
| Centre Console Storage..... | 36 |
| Door Panel Storage..... | 36 |
| Load Compartment..... | 37 |
| Load Compartment Cover..... | 37 |
| Rear Floor Storage Cover..... | 37 |
| Lashing Eyes..... | 38 |
| Warning Triangle..... | 38 |
| First Aid Kit..... | 38 |
| Roof Rack System..... | 38 |
| | 38 |
| Loading Information..... | 39 |

Storage Compartments



Warning

Do not store heavy or sharp objects in the storage compartments.

Glove Box

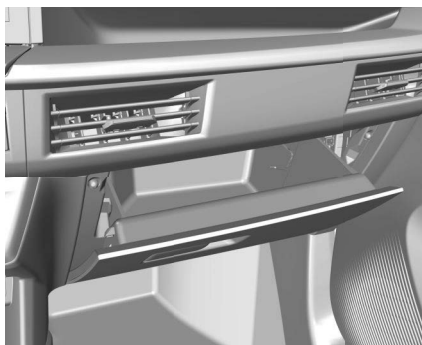

The glove box should be closed whilst driving.

Cupholders

Cupholders are located in the centre console.

Front Storage

Depending on version, one or two storage compartments are located at the instrument panel.

A storage compartment for inductive charging is located beneath the instrument panel → page 56

Centre Console Storage

The storage container can be used to store small items.

Depending on the version, the storage compartment is located under a cover.

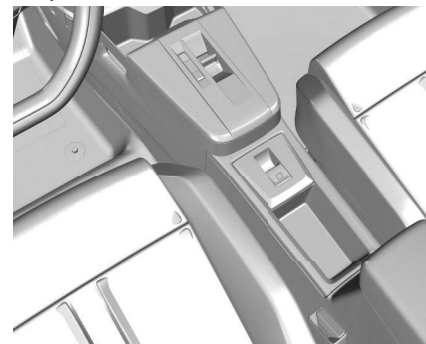

Door Panel Storage

A storage compartment is located in the front and rear door panels.



Load Compartment

The rear seat backrest is divided in two parts. Both parts can be folded down.

Warning

When folding up, ensure that backrests are securely locked in position before driving. Failure to do so may result in personal injury or damage to the load or vehicle in the event of hard braking or a collision.

Before folding rear seat backrests, execute the following if necessary:

- Remove the load compartment cover
⇒ page 37.

- Press and hold the catch to push the head restraints down ⇒ page 16

Rear seats ⇒ page 19

Load Compartment Cover

Do not place any objects on the cover.

Removing cover

To remove the cover:

- Unhook the two cords.
- Lift the cover, then remove it.

There are several ways of storing it:

- Either upright behind the front seats.
- Or flat on the bottom of the boot.

Stowing

The load compartment cover can be stored behind the rear seat backrests. Unhook retaining straps and lift the cover backwards until it unlatches. Then slide it down in the guides behind the seat backrests.

Fitting cover

Engage cover in side guides and fold downwards. Attach the retaining straps to the tailgate.

Rear Floor Storage Cover

Raise the cover at the recess to gain access to emergency breakdown equipment.

Tire repair kit ⇒ page 150

Spare wheel ⇒ page 154

Double Load Floor

The double load floor can be inserted in the load compartment in two positions:

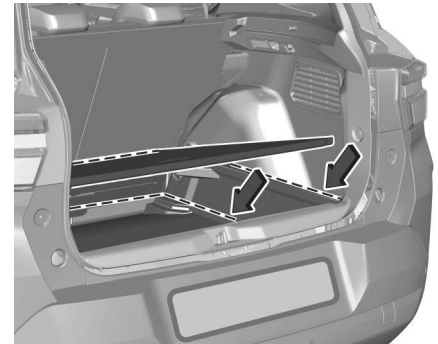

- lower position above the rear floor storage cover
- upper position interlocked

If mounted in the upper position, the space between the load floor and the spare wheel well cover can be used as a storage compartment.

In this position, if the rear seat backrests are folded forwards, an almost completely flat load bay is created. In the upper position, the double load floor is able to withstand a maximum load of 100 kg. In the lower position, the double load floor is able to withstand the maximum permissible load.

Lashing Eyes



The lashing eyes are designed to secure items against slippage, e.g. using lashing straps or luggage net.

Warning Triangle

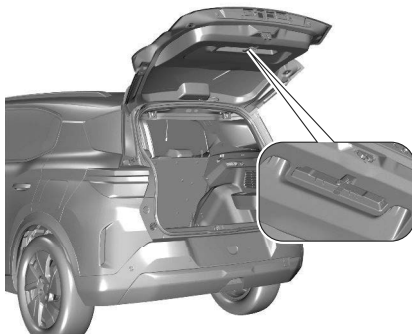

Stow the warning triangle in the space at the rear of the trunk door and secure it with the Velcro® fastener.

First Aid Kit

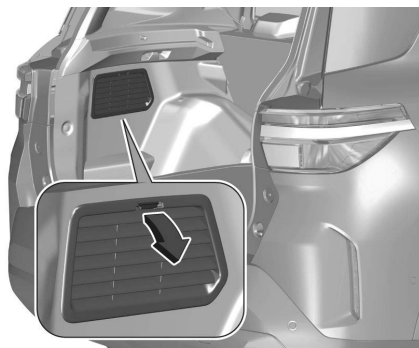

Fold down the cover on the left side of the load compartment. Stow the first aid kit in the storage compartment.

Roof Rack System

For safety reasons and to avoid damage to the roof, the vehicle approved roof rack system is recommended. Follow the installation instructions and remove the roof rack when not in use.

Mounting Roof Rack Without Rail

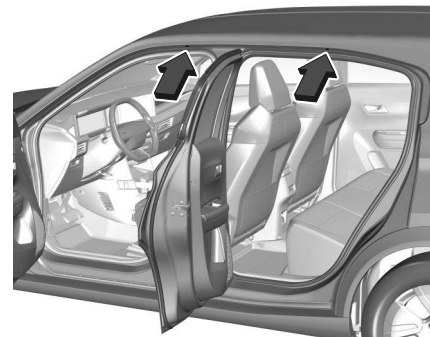

Open all doors. Mounting points are located in each door frame of the vehicle body. Fasten the roof rack according to the installation instructions delivered with the roof rack.

Mounting Roof Rack With Rail

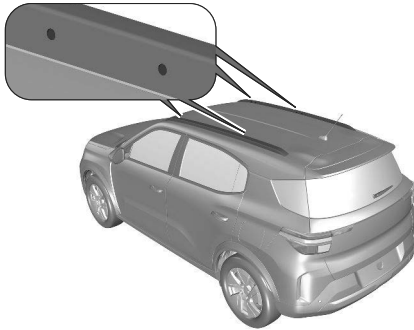

Markings at the roof rails indicate where the roof rack is to be installed.

Loading Information

Warning

Always make sure that the load in the vehicle is securely stowed. Otherwise objects can be thrown around inside the vehicle and cause personal injury or damage to the load or car.

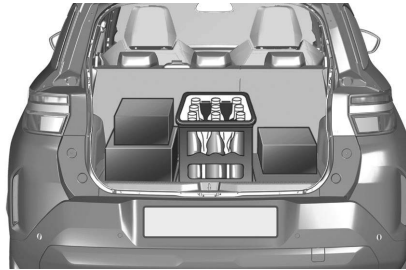

- Heavy objects in the load compartment should be placed against the seat backrests. Make sure that the backrests are securely engaged ⇒ page 37. If objects can be stacked, heavier objects should be placed at the bottom.
- Prevent sliding of loose objects by securing them with straps attached to the lashing eyes ⇒ page 38.
- Do not allow the load to protrude above the upper edge of the backrests.
- Do not place any objects on the load compartment cover or the cluster, and do not cover the sensor on top of the instrument panel.
- The load must not obstruct the operation of the pedals, parking brake

and gear selector, or hinder the freedom of movement of the driver. Do not place any unsecured objects in the interior.

- Do not drive with an open load compartment.
- The payload is the difference between the permitted gross vehicle weight (see identification plate ⇒ page 165) and the EC kerb weight.
To calculate the payload, enter the data for your vehicle in the weights table at the front of this manual.
The EC kerb weight includes weights for the driver (68 kg), luggage (7 kg) and all fluids (fuel tank 90% full).
Optional equipment and accessories increase the kerb weight.
- Driving with a roof load increases the sensitivity of the vehicle to cross-winds and has a detrimental effect on vehicle handling due to the vehicle's higher centre of gravity.
Distribute the load evenly and secure it properly with retaining straps. Adjust the tire pressure and vehicle speed according to the load conditions. Check and retighten the straps frequently. Do not drive faster than 120 km/h. The permissible roof load is 60 kg. The roof load is the combined weight of the roof rack and the load.

Dashboard Instruments And Controls

| | | | | | |
|-----------------------------------|----|--------------------------------------|----|---------------------------------|----|
| Instrument Panel Overview..... | 41 | Hybrid System Fault..... | 48 | Smart Card, Smart Key..... | 52 |
| | 42 | Brake System..... | 49 | Active Emergency Braking..... | 52 |
| Steering Wheel Adjustment..... | 42 | Electric Parking Brake..... | 49 | Fuel Gauge..... | 53 |
| Steering Wheel Controls..... | 43 | Electric Parking Brake Fault..... | 49 | High Voltage Battery Gauge..... | 53 |
| Horn..... | 43 | Antilock Brake System (ABS)..... | 49 | Power Indicator Gauge..... | 53 |
| Pedestrian Safety Alert..... | 43 | Gear Shifting..... | 49 | Vehicle Range..... | 54 |
| Windscreen Wiper and Washer..... | 43 | Power Steering..... | 49 | Digital Speedometer..... | 54 |
| Windscreen Wiper With | | Lane Keeping Assist..... | 49 | Odometer..... | 54 |
| Adjustable Wiper Frequency..... | 43 | Apply Footbrake..... | 50 | Trip Odometer..... | 54 |
| Windscreen Wiper With Rain | | Parking Assist..... | 50 | Engine Coolant Temperature | |
| Sensor..... | 44 | Electronic Stability Control and | | Gauge..... | 54 |
| Windscreen Washer..... | 44 | Anti-Slip Regulator (ASR)..... | 50 | Engine Oil Level Monitor..... | 55 |
| Rear Window Wiper And Washer..... | 45 | Electronic Stability Control and | | Service Display..... | 55 |
| Rear Window Wiper..... | 45 | Anti-Slip Regulator (ASR)..... | 50 | Inductive Charging..... | 56 |
| Rear Window Washer..... | 45 | Engine Coolant Temperature..... | 50 | 12 V Power Outlet..... | 56 |
| Outside Temperature..... | 45 | Preheating..... | 50 | USB Port..... | 57 |
| Warning And Control Indicator | | Exhaust Filter..... | 50 | Displays..... | 57 |
| Lights..... | 45 | Tire Deflation Detection System..... | 51 | Vehicle Messages..... | 58 |
| Overview..... | 45 | Engine Oil Pressure..... | 51 | Vehicle Customization..... | 59 |
| Turn Lights..... | 47 | Low Fuel..... | 51 | Telematics services..... | 59 |
| Seat Belt Reminder..... | 47 | Vehicle Ready..... | 51 | Opel Connect..... | 59 |
| Airbag And Belt Tensioners..... | 47 | Reduced Engine Power..... | 51 | Emergency Call..... | 60 |
| Airbag Deactivation..... | 48 | High voltage Battery | | GLONASS..... | 60 |
| Charging System..... | 48 | Temperature High..... | 51 | | |
| Malfunction Indicator Light..... | 48 | Autostop..... | 51 | | |
| Service Vehicle Soon..... | 48 | Exterior Light..... | 52 | | |
| Stop Engine..... | 48 | Low Beam..... | 52 | | |
| System Check..... | 48 | High Beam..... | 52 | | |
| | | High Beam Assist..... | 52 | | |
| | | Front Fog Lights..... | 52 | | |
| | | Rear Fog Light..... | 52 | | |
| | | Rain Sensor..... | 52 | | |
| | | Pedestrian Safety Alert Fault..... | 52 | | |

Instrument Panel Overview



- 1 Power windows ⇨ page 13
- 2 Exterior mirrors ⇨ page 10
- 3 Side air vents ⇨ page 87
- 4 High beam, headlight flash, turn lights, fog lights, parking lights ⇨ page 76
- 5 Cruise control, Speed limiter ⇨ page 131
- 6 Cluster ⇨ page 57
- 7 Infotainment controls ⇨ page 65
- 8 Windscreen wiper and washer, rear wiper and washer ⇨ page 43
- 9 Power button ⇨ page 91
- 10 Central locking button ⇨ page 6
- 11 Touch screen display ⇨ page 58
- 12 Centre air vents ⇨ page 87
- 13 Hazard warning flashers ⇨ page 78
- 14 Reading lights ⇨ page 81
- 15 Emergency call ⇨ page 60
- 16 Interior lights ⇨ page 81
- 17 Seat belt reminder, airbag deactivation ⇨ page 47
- 18 Interior mirror ⇨ page 12
- 19 Airbag deactivation ⇨ page 48
- 20 Glove box ⇨ page 36
- 21 Heated rear window, heated windscreen, heated seats, heated steering wheel, electronic climate control system ⇨ page 83
- 22 USB port ⇨ page 57
- 23 Front storage, wireless charging ⇨ page 36
- 24 Gear selection, selector lever ⇨ page 94
- 25 Parking brake ⇨ page 100
- 26 Steering wheel adjustment ⇨ page 42
- 27 Horn ⇨ page 43
- 28 Bonnet release lever ⇨ page 140
- 29 Headlight range adjustment ⇨ page 78
Electronic stability control and traction system ⇨ page 121
Lane keep assist ⇨ page 125
Traffic sign assist ⇨ page 134

Steering Wheel Adjustment

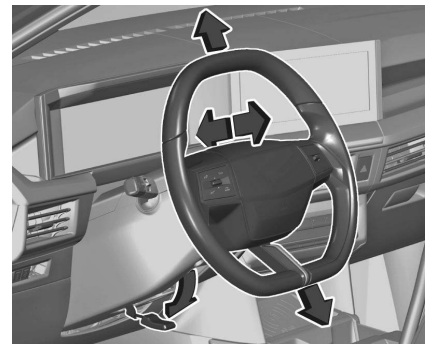

Unlock the lever, adjust the steering wheel, then engage the lever and ensure it is fully locked.

Do not adjust the steering wheel unless the vehicle is stationary and the steering wheel lock has been released.

Steering Wheel Controls



The cluster menu, some driver assistance systems, the Infotainment system and a connected mobile phone can be operated via the controls on the steering wheel.

Advanced driving assistance systems → page 116

Infotainment System → page 62

Horn



Pedestrian Safety Alert

The sound of the pedestrian safety alert is generated to indicate the vehicle presence to pedestrians. It is active up to 30 km/h.

Windscreen Wiper and Washer

Note

With the wiper lever in position AUTO or INT, 1 or 2 and the ignition switched on after more than one minute: When the outside temperature is below +3°C, the windscreen wiper activates only at

a speed above 10 km/h. When the outside temperature is above +3°C, the windscreen wiper activates immediately.

Note

In position 1 or 2, the wiping frequency is automatically reduced at a speed below 5 km/h and returns to the original frequency at a speed above 10 km/h.

Windscreen Wiper With Adjustable Wiper Frequency



- 2 : fast
- 1 : slow
- INT : interval wiping
- 0 : off
- x1 : single wipe

Do not use if the windscreen is frozen.

Switch off in car washes.

To activate interval wiping mode the next time the ignition is switched on, press the lever downwards to position OFF and back to INT.

Wiper frequency

Wiper lever in position **INT**, the wiping frequency is depending of the speed of the vehicle.

Windscreen Wiper With Rain Sensor

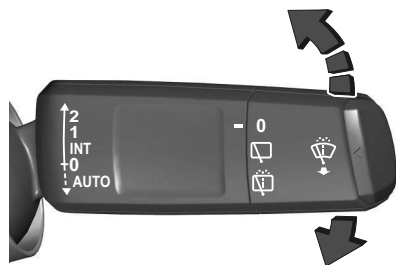

- 2** : fast
- 1** : slow
- INT** : interval wiping
- 0** : off

AUTO : automatic wiping with rain sensor

In **AUTO** position, the rain sensor detects the amount of water on the windscreen and automatically regulates the frequency of the windscreen wiper. If the ignition is switched off, automatic wiping mode is deactivated. To activate automatic wiping mode the next time the ignition is switched on, press the lever downwards to position **OFF** and back to **AUTO**.

Do not use if the windscreen is frozen.
Switch off in car washes.

Adjustable sensitivity of the rain sensor



Wiper lever in position **AUTO**.
In **AUTO** position, the rain sensor detects the amount of water on the

windscreen and automatically regulates the frequency of the windscreen wiper. The sensitivity can be adjusted with the switch on the stalk. Push upwards to increase and downwards to decrease sensitivity.

Make sure the sensor is not blocked ⇒ page 12.

Control indicator ⇒ page 91.

Windscreen Washer



Pull and hold the wiper control stalk towards you beyond the point of resistance.

A final wiping cycle is performed when screenwashing ends.



For single wipe, pull the wiper control stalk towards you without going beyond the point of resistance.

Washer fluid ⇒ page 143

Rear Window Wiper And Washer



Rear Window Wiper



- 0 : off
-  : intermittent wiping
-  : screen wash

Do not use if the rear window is frozen or when a bicycle carrier is used. Switch off in car washes. The rear window wiper comes on automatically when the windscreen wiper is switched on and reverse gear is engaged.

Rear Window Washer

Select . Washer fluid is sprayed onto the rear window and rear view camera and the wiper wipes as long as  is selected. Washer fluid ⇒ page 143

Outside Temperature

The outside temperature is shown on the cluster display or in the status bar of the Info Display.

Warning And Control Indicator Lights

The control indicators described are not present in all vehicles. The description applies to all instrument versions. Depending on the equipment, the position of the control indicators may vary.









When the ignition is switched on, most control indicators will illuminate briefly as a functionality test.

The control indicator colours mean:

- red** : danger, important reminder
- yellow** : warning, information, fault

- green** : confirmation of activation
- blue** : confirmation of activation
- white** : confirmation of activation
- grey** : system paused, at least one system limitation has been detected

Overview

-  1 Turn lights ⇒ page 47
-  2 Seat belt reminder ⇒ page 47
-  5 Airbag and belt tensioners ⇒ page 47
-  2 Airbag activated ⇒ page 47
-  2 Airbag deactivated ⇒ page 48
-  4 Charging system ⇒ page 48
-  5 Malfunction indicator light ⇒ page 48
-  2 System check ⇒ page 48



2/3 Traffic sign assistant ⇒
page 52



2/3 Driver alert ⇒ page
53



2 Door open ⇒ page 53

Turn Lights

↔ illuminates or flashes green.

Illuminates briefly

The parking lights are switched on.

Flashes

A turn light or the hazard warning flashers are activated.

Rapid flashing: failure of a turn light or associated fuse.

This includes turn lights connected to the socket of the towing equipment.



Bulb replacement ⇒ page 145.

Turn lights ⇒ page 79 .

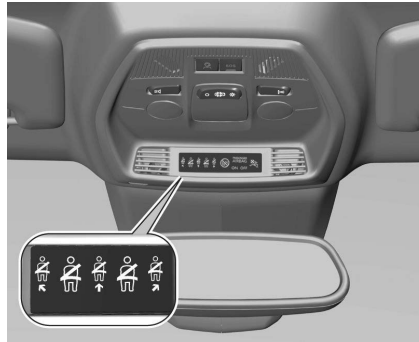
Seat Belt Reminder



 The belt indicator illuminates or flashes red on the instrument cluster together with the indication in the overhead console for each seat belt.

- When the ignition is switched on,  on the instrument cluster and the symbol for the respective seat in the overhead console comes on, if the seat belt of any occupied seat has not been fastened.
- After driving off,  on the instrument cluster and the symbol for the respective seat in the overhead console flashes for a certain time together with a chime. After a certain time of driving  illuminates

constantly until the seat belt of the respective seat has been fastened or if any passenger has unfastened the seat belt.

Seat belts ⇒ page 20

Airbag And Belt Tensioners

 illuminates red.

When the ignition is switched on, the control indicator illuminates for approx. four seconds. If it does not illuminate, does not extinguish after four seconds or illuminates whilst driving, there is a fault in the airbag system.

Seek the assistance of a workshop.

The airbags and belt pretensioners may fail to trigger in the event of an accident. Deployment of the belt pretensioners or airbags is indicated by continuous

illumination of .

Warning

Have the cause of the fault remedied immediately by a workshop.

Belt pretensioners ⇒ page 20

Airbag system ⇒ page 22

Airbag Deactivation



illuminates yellow.

The front passenger airbag is activated.



illuminates yellow.

The front passenger airbag is deactivated.

Airbag deactivation ⇒ page 25

Charging System



illuminates red.

Illuminates when the ignition is switched on and extinguishes shortly after the engine starts.

Illuminates when the engine is running

Stop, switch off the engine. The vehicle battery is not charging. The engine cooling may be interrupted. The brake

servo unit may cease to be effective. Seek the assistance of a workshop.

Malfunction Indicator Light



illuminates or flashes yellow.

Illuminates or flashes yellow when the ignition is switched on and extinguishes shortly after the engine starts.

Illuminates when the engine is running

Fault in the emission control system. The permitted emission limits may be exceeded. Seek the assistance of a workshop immediately.

Flashes when the engine is running

The engine management system has a fault that could lead to catalytic converter damage. Ease up on the accelerator until the flashing stops. Seek the assistance of a workshop immediately.

Service Vehicle Soon



illuminates yellow.

Illuminates briefly when the ignition is switched on.

May illuminate together with other control indicators and a corresponding message on the cluster.

Seek the assistance of a workshop immediately.

Stop Engine



illuminates red.

Illuminates briefly when the ignition is switched on.

Illuminates together with other control indicators, accompanied by a warning chime and a corresponding message on the cluster.

Stop the engine immediately and seek the assistance of a workshop.

System Check



illuminates yellow or red.

Illuminates yellow

A minor engine fault has been detected.

Illuminates red

A major engine fault has been detected. Stop engine as soon as possible and seek the assistance of a workshop.

Hybrid System Fault



illuminates red.

The hybrid system has a fault. Switch off ignition and seek the assistance of a workshop.

Brake System

(ⓘ) When the symbol illuminates red the brake and clutch fluid level is too low, when parking brake is not applied.

Warning

Stop. Do not continue your journey. Consult a workshop.

Illuminates when the manual parking brake is applied and the ignition is switched on ⇒ page 99
Brake fluid ⇒ page 143

Electric Parking Brake

(Ⓟ) illuminates or flashes red.

Illuminates

Parking brake is applied ⇒ page 99

Flashes

Electric parking brake is not applied automatically. The application or the release is faulty.

Warning

Have the cause of the fault remedied immediately by a workshop.

Electric Parking Brake Fault

(Ⓟ)! illuminates yellow.

Illuminates

Electric parking brake has a fault ⇒ page 99

Warning

Have the cause of the fault remedied immediately by a workshop.

Antilock Brake System (ABS)

(ABS) The symbol illuminates yellow for a few seconds after the ignition is switched on.

The system is ready for operation when the control indicator extinguishes. If the control indicator does not extinguish after a few seconds, or if it illuminates while driving, there is a fault in the ABS. The brake system remains operational but without ABS regulation. Antilock brake system ⇒ page 99

Gear Shifting

Automatic transmission manual mode

▲▼ On vehicles with automatic transmission, the system is only active in manual mode.

Upshifting or downshifting is recommended for fuel saving reasons. Automatic transmission Hybrid 48 V ⇒ page 95

Power Steering

(Ⓢ)! illuminates red or yellow.

The power steering has a fault. Drive carefully at a moderate speed and consult a workshop

Lane Keeping Assist

 illuminates or flashes yellow.

Illuminates

A fault has been detected.

Flashes

The system is correcting the unintended lane change.

Lane Keeping Assist ⇒ page 125

Apply Footbrake

 Illuminates.

Insufficient or no pressure on the brake pedal. Depress the brake pedal before releasing the parking brake and moving out of P.

Parking Assist

P¹)  illuminates or flashes yellow.

Illuminates

A fault has been detected.

Flashes

Flashes as soon as an obstacle gets closer to the vehicle.

Parking assist ⇒ page 127

Electronic Stability Control And Anti-Slip Regulator (ASR)

 illuminates or flashes yellow.

Illuminates

A fault in the system is present.

Continued driving is possible. Driving stability, however, may deteriorate depending on road surface conditions.

Have the cause of the fault remedied by a workshop.

After reconnecting the vehicle battery, (e.g. after maintenance work),  is illuminated for several seconds. After this

time period,  extinguishes. This is a normal procedure, the vehicle does not need any assistance.

Flashes

The system is actively engaged.

Engine output may be reduced and the vehicle may be braked automatically to a small degree.

Electronic Stability Control ⇒ page 121

Electronic Stability Control And Anti-Slip Regulator (ASR)

 illuminates yellow.

Electronic Stability Control and Anti-Slip Regulator (ASR) are deactivated.

Anti Slip Regulator ⇒ page 120

Electronic Stability Control ⇒ page 121

Engine Coolant Temperature

 illuminates red.

Illuminates when the engine is running

Stop, switch off the engine.

Caution

Coolant temperature too high.

Check coolant level immediately ⇒ page 142

If there is sufficient coolant, consult a workshop.

Preheating

 illuminates yellow.

The symbol illuminates yellow only when the outside temperature is low. Start the engine when the control indicator extinguishes.

Starting the engine ⇒ page 90

Exhaust Filter

 The symbol illuminates yellow when the exhaust filter requires cleaning. Continue driving until the control indicator extinguishes.

Illuminates temporarily

Start of saturation of the exhaust filter.

Start cleaning process as soon as possible by driving at a vehicle speed of at least 60 km/h.

Illuminates constantly

Indication of a low additive level. Seek the assistance of a workshop.

Tire Deflation Detection System

 illuminates or flashes yellow.

Illuminates

Tire pressure loss in one or more wheels. Stop immediately and check the tire pressure.

Flashes

Fault in the system. Consult a workshop. Tire Deflation Detection System ⇒ page 133

Engine Oil Pressure

 illuminates red when the ignition is switched on and extinguishes shortly after the engine starts.

Illuminates when the engine is running**Caution**

Engine lubrication may be interrupted. This may result in damage to the

engine and / or locking of the drive wheels.

1. Select neutral gear.
2. Move out of the flow of traffic as quickly as possible without impeding other vehicles.
3. Switch off the ignition.

Warning

When the engine is off, considerably more force is needed to brake and steer.

During an Autostop, the brake servo unit will still be operational. Do not remove key until vehicle is stationary, otherwise the steering wheel lock could engage unexpectedly.

Keep engine turned off and let the vehicle be towed to a workshop.

Low Fuel

 illuminates yellow. Level in fuel tank is too low. Refuelling ⇒ page 110

Vehicle Ready

^{READY}  illuminates green. The hybrid system is active.

Reduced Engine Power

 illuminates yellow. The charging level of the high voltage battery is low. Only reduced engine power is available.

High Voltage Battery Temperature High

 illuminates red. Illuminates briefly when the ignition is switched on. Illuminates together with other control indicators, accompanied by a warning chime and a corresponding message in the cluster. Stop engine immediately and evacuate the vehicle.

Autostop

 Illuminates briefly when the ignition is switched on.

Illuminates green

Engine is in an Autostop.

Illuminates yellow

Hybrid 48 V vehicle: automatic switching to electrical engine only has been deactivated manually.

Automatic transmission Hybrid 48 V ⇒ page 95

Flashes green

Autostop is temporarily unavailable, or Autostop mode is invoked automatically. Stop-start system ⇒ page 91

Exterior Light

 illuminates green.

The exterior lights are on ⇒ page 76

Low Beam

 illuminates green.

Illuminated when low beam is on.

High Beam

 illuminates blue.

Illuminated when high beam is on or during headlight flash ⇒ page 77

High Beam Assist

AUTO
 illuminates green.

The high beam assist is activated ⇒ page 77

Front Fog Lights

 illuminates green.

The front fog lights are on ⇒ page 79

Rear Fog Light

 illuminates yellow.

The rear fog light is on ⇒ page 79

Rain Sensor

AUTO
 illuminates green.

Illuminates when rain sensor position on wiper lever is selected.

Windscreen wiper and washer ⇒ page 43

Pedestrian Safety Alert Fault

 illuminates yellow.

The pedestrian safety alert is not working.

Smart Card, Smart Key

 illuminates yellow.

Smart card, smart key not detected or failure ⇒ page 4

Active Emergency Braking

 illuminates or flashes yellow. Illuminates

The system has been deactivated or a fault has been detected.

Additionally, a warning message is displayed in the cluster.

Check the reason of the deactivation and in case of a system fault, seek the assistance of a workshop.

Note

 also illuminates if the seat belts of the front passengers are not fastened.

In this case, active emergency braking is deactivated.

Flashes

The system is actively engaged.

Depending on the situation, the vehicle may automatically brake moderately or hard.

Active Emergency Braking ⇒ page 116

Traffic Sign Assistant



 illuminates for a few seconds or permanently.

Illuminates for a few seconds



If the vehicle exceeds the speed limit provided by the traffic sign assistant, the speed limit displayed in the cluster

flashes and an audible signal is given. If flashing and audible signal are deactivated,  illuminates for a few seconds.

Illuminates permanently

If the traffic sign assistant has a failure,  illuminates permanently. Stop the vehicle and check, if the camera needs to be cleaned. If  still illuminates after cleaning the camera, consult a workshop
Traffic sign assistant ⇨ page 134

Driver Drowsiness Detection

 illuminates yellow. If the steering inputs of the driver suggest a certain level of drowsiness or inattention by the driver,  illuminates and an audible signal is given. Driver Drowsiness Detection (DDD) ⇨ page 130

Door Open

 illuminates red. A door or the tailgate is open.

Fuel Gauge



Displays the fuel level in the tank.

Control indicator  illuminates if the level in the tank is low. Never run the fuel tank dry. The top-up quantity may be less than the specified fuel tank capacity, due to the remaining fuel in the tank.

High Voltage Battery Gauge



Displays the high voltage battery state of charge.

Power Indicator Gauge



The power indicator gauge informs about the current energy situation of the vehicle.

Power : Energy consumption during high power demand. Hybrid 48 V vehicles:

ICE and electrical engine work combined.

Eco : An optimum in energy is accessible in all driving modes. Hybrid 48 V vehicles: optimum usage of ICE or electric engine.

Charge : Battery is being charged with energy resulting from braking or deceleration of the vehicle.

Vehicle Range

Displays the total vehicle range.

Digital Speedometer



Indicates the vehicle speed.

Odometer

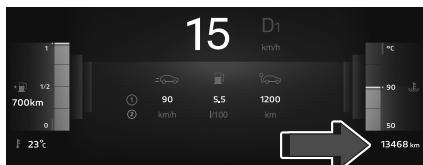

The total recorded distance of the vehicle is displayed in the right bottom corner of the cluster.

Trip Odometer

The following trip odometer pages are selectable in trip/autonomy information menu or by pressing on the right stalk button:

- Trip in progress with instantaneous fuel consumption
- Trip 1 or 2 with average consumption, average speed and trip distance

Hybrid 48 V vehicle: the distance percentage of electric driving is shown additionally.

Instrument Cluster ⇒ page 57

Engine Coolant Temperature Gauge



Displays the coolant temperature.

- 50** engine operating temperature not yet reached
- 90** normal operating temperature

Top of the gauge temperature too high

Control indicator  illuminates red if engine coolant temperature is too high.

Caution

If the engine coolant temperature is too high, stop the vehicle, switch off the

engine. Danger to the engine. Check the coolant level.

Engine Oil Level Monitor

The state of the engine oil level is displayed in the cluster for a few seconds following the service information after switching on the ignition.

A proper state of engine oil level is indicated by a message.

If the engine oil level is low, the two

indicators   flash and a message is indicated.

Confirm the engine oil level by using the dipstick and top up engine oil respectively.

Engine oil ⇨ page 141.

A fault of measurement is indicated by a message. Check the engine oil level manually by using the dipstick.

Service Display

The service system informs when to change the engine oil and filter or a vehicle service is required. Based on driving conditions, the interval at which an engine oil and filter change is required can vary considerably.

Service information ⇨ page 163

A required service due is displayed in the cluster for several seconds after switching on the ignition.

If no service is required for the next 3000 km or more, no service information appears in the display.

If service is required within the next 3000 km, the remaining distance or time duration is indicated for several seconds.

Simultaneously indicator  illuminates permanently as reminder.

If service is required in less than 1000 km, indicator flashes and then illuminates permanently. The remaining distance or time duration is indicated for several seconds.

Overdued service is indicated by a message in the cluster which indicates the overdued distance. The indicator flashes and then illuminates permanently until service is executed.

Reset of service interval

After each service, the service indicator must be reset to ensure proper functionality. It is recommended to seek the assistance of a workshop. Operate as following:

- Switch off the ignition.

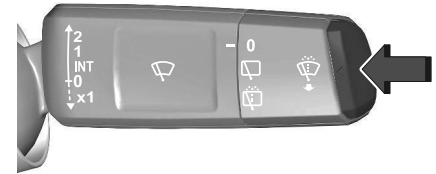

- Press the end of the right stalk to access menu.
- Scroll through the pages using the steering wheel toggle up and down.
- Once the desired menu has been reached, press and hold the button to reset.
- When the display indicates "0", release the button. The indicator then disappears.

Retrieving service information

To retrieve the status of the service information at any time:

- Press the end of the right stalk to access the menu.

- Scroll through the pages using the steering wheel toggle up and down.
- Short press on the toggle when in the service menu.

The service information is displayed for a few seconds.

Service information ⇒ page 163

Inductive Charging

Warning

When using applications for a long time in combination with wireless charging, some smartphones may switch to thermal safety and cause some functions to stop.

Warning

Inductive charging can affect the operation of implanted pacemakers or other medical devices. If applicable, seek medical advice before using the inductive charging device.

Warning

Remove any metal objects from the charging device before charging a

mobile device, as these objects could become very hot.

This system allows wireless charging of a mobile device such as a smartphone, using the magnetic induction principle, in accordance with the Qi.

The mobile device to be charged must be compatible with the Qi standard, either by design or by using a compatible holder or shell.

To charge a mobile device:

1. Remove all objects from the charging device.
2. Place the mobile device on the charging area. Note that the mobile device must be placed between the positioning aids.

On some mobile devices, a back cover with an integrated coil or a jacket may be required to use inductive charging.

A protective cover for the mobile device could have impact on the inductive charging.

In the event that the mobile device is not charging properly, rotate it 180° and place it on the charging device again.

Status LED

The LED indicates the current charging status.

Illuminates green

The mobile device is charging.

Flashes orange

The mobile device has not been centred properly in the charging zone or an unknown object has been detected in the charging zone.

Illuminates orange

There is a problem with the mobile device's battery or a fault of the inductive charger has been detected. If the problem persists, seek the assistance of a workshop.

12 V Power Outlet



Plug in a 12 V accessory (with a maximum rated power of 120 W) using a suitable adapter.

Observe the maximum power rating to avoid damaging the accessory.

Do not exceed the maximum power consumption of 120 W.

The 12 V power outlet is deactivated in the event of low vehicle battery voltage. Electrical accessories that are connected must comply with the electromagnetic compatibility requirements laid down in DIN VDE 40 839.



Do not connect any current-delivering accessories, e.g. electrical charging devices or batteries.

Do not damage the outlet by using unsuitable plugs.

USB Port



These symbols determine the type of use of a USB socket:

-  Power supply and recharging.
-  To connect a portable device to the Infotainment system, use this port
-  Likewise, plus use of smartphone applications with the touch screen.

The vehicle is fitted with two USB sockets on the dashboard.

Two USB sockets on the 2nd row.

Note

The sockets must always be kept clean and dry.

Displays

Instrument Cluster



In addition to warning lights, gauges and indicators, the following information is available:

- trip odometer
- gear shift indication
- service information
- vehicle and warning messages
- driver assistance messages
- pop-up messages
- infotainment information



Press the button to scroll through the pages or to close a pop-up message.

Vehicle settings and driving functions

Select one of the following settings:

- Driving assistance

- User settings

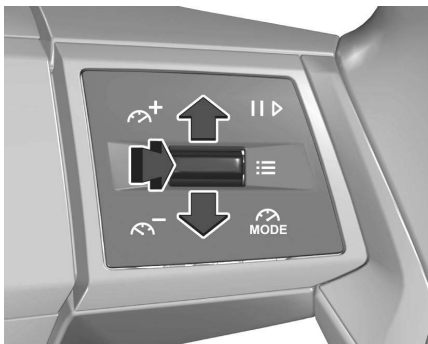

Short press: select or confirm a menu or setting.

Long press: resetting the service reminder.

Toggle up or down: scroll through the settings menus.

Information Display

The Information Display can indicate:

- time
- outside temperature
- date
- Infotainment system, see description in the Infotainment system section ⇒ page 62
- indication of rear view camera ⇒ page 129

- indication of parking assist instructions ⇒ page 127
- navigation, see description in the Infotainment system section ⇒ page 69
- vehicle and system messages ⇒ page 58
- settings for vehicle personalization ⇒ page 59

Navigation System

Selecting menus and settings

Menus and settings are accessed via the touchscreen.



Touch the screen to switch on the display.

Press  to display the homepage.
Touch required menu display icon.

Touch a respective icon to confirm a selection.

Touch  to return to the next higher menu level.

Press  to return to the homepage.
For further information, see Infotainment system section.

Vehicle personalization ⇒ page 59

Vehicle Messages

Messages are indicated in the information cluster, in some cases together with a warning chime.



Press to confirm a message.

Vehicle and service messages

The vehicle messages are displayed as text. Follow the instructions given in the messages.

Messages in the information cluster

Some important messages may appear additionally in the Info Display. Some messages only pop-up for a few seconds.

Vehicles with navigation system

The vehicle recognises low emission zones. An audible message is given when entering or exiting a low emission zone and an icon will be shown on the navigation map.

Warning Chimes

The warning chime regarding not fastened seat belts has priority over any other warning chime.

Whenever a warning chime sounds, pay attention to the messages displayed and the warning lights on the information cluster.

When a failure is detected in the sound

module  Appears on the cluster accompanied by a display message. No warning chime will sound, also not for the driver assistance system.

When starting the engine or whilst driving

A warning chime will sound in situations such as

- a seat belt is not fastened

- a door or the tailgate is not fully closed
- a certain speed is exceeded with parking brake applied
- cruise control deactivates automatically
- a programmed speed or speed limit is exceeded
- a warning message appears on the cluster
- the electronic key is not in the passenger compartment
- the parking assist detects an object
- an unintended lane change occurs
- the exhaust filter has reached the maximum filling level
- hands-off driving is recognized
- drowsiness of the driver is recognized
- a vehicle directly ahead is approached too quickly

When the vehicle is parked and / or the driver's door is opened

A warning chime will sound when :

- the exterior lights are on
- the key is in the ignition switch

Vehicle Customization

The vehicle's behaviour can be personalized by changing the settings in the Info Display.

Some functions are only displayed or active when the engine is running.

Telematics Services

Opel Connect

Opel Connect comprises multiple connected services accessible via app, online or within the vehicle.

Note

Opel Connect is not available for all markets. For further information, contact your workshop.

Note

Full functionality of Opel Connect is subject to registration and proper activation.

Connected services may include live navigation such as online traffic information and vehicle status and information such as maintenance alerts.

Services accessible within the vehicle also include emergency call and breakdown call. These functions are automatically activated. Terms and conditions apply.

Emergency call ⇨ page 60

Breakdown call

Press the button in the overhead console for more than two seconds connects to a roadside assistance service provider. For information about coverage and scope of services of the roadside assistance, please refer to the information provided by the Opel Distributor with the order form.

Privacy settings

Privacy settings of Opel Connect can be configured in your vehicle. This will impact the set of data being sent, e.g., in case a breakdown call is triggered. The emergency call function will not be impacted.

Privacy settings also affect MyOpel. Depending on version, the privacy settings can be changed by simultaneously pressing the button and SOS in the overhead console or via the system settings menu in the Info Display.

Emergency Call

Note

In order to be available and operational, the system requires functioning vehicle electrics, mobile service and GPS satellite link. Depending on equipment, a backup battery is used.

Note

The service is only available for markets where it is legally required. Furthermore, it depends on the availability of the emergency centres and the infrastructure in the country.

Status LED in the overhead console

Illuminates green and red and extinguishes after a short time, when the ignition is switched on: the system works properly.

Illuminates red: fault in the system.

Contact a workshop.

Flashes red: backup battery needs replacement. Contact a workshop.

Emergency call

The emergency call function will establish a connection to the nearest public safety answering point (PSAP).

A minimum set of data including vehicle and location information will be sent to the PSAP.

In case of an emergency, press the red SOS button in the overhead console for more than two seconds.

The LED flashes green to confirm that a connection to the nearest PSAP is being established. The LED illuminates steadily as long as the call is active.

Pressing the SOS button immediately a second time will terminate the call.

The LED switches off.

Automatic crash notification

In case of an accident with airbag deployment and without damage of needed hardware, an automatic emergency call is established and an automatic crash notification will be transmitted to the next PSAP.

GLONASS

ERA GLONASS is a manually or automatically actuated emergency service. Emergency centres provide assistance and information during an emergency.

In case of an accident with an impact of appropriate severity, an emergency call is placed automatically, regardless of airbag activation. An immediate connection with an advisor will be established who will check whether help is needed.



Warning

The service is only available for markets where it is legally required and activated. Furthermore, the manual and the automatic emergency call function depend on the availability of the emergency centres and the infrastructure in the country.

Note

In order to be available and operational, the system requires functioning vehicle electrics, mobile service and GLONASS satellite link.

Depending on equipment, a backup battery is used.

Control buttons**SOS button**

In an emergency situation press and hold SOS button for more than two seconds. The green LED and the voice message will confirm that the call has been sent to the emergency centre.

The green LED illuminates when the service connection is established. It will extinguishes when the connection is complete.

A minimum set of data is transferred to the emergency centre, including such data as car location, car model, vehicle identification number. The operator will contact you and, if necessary, send rescue workers from the relevant support services.

To cancel the call, press the SOS button again. The green LED extinguishes. The voice message confirms the cancellation.

Status LED

- | | |
|---------------------|--|
| Green | The system is activated. A connection to an operator is on duty. |
| Red | The system is booting up after switching on the ignition, the LED extinguishes after 3 seconds. If the LED stays red, a malfunction has been detected in the system. An emergency call may not work. Contact a workshop immediately. |
| Red flashing | The internal backup battery is defective. Contact a workshop immediately. |

Seek the assistance of a workshop if the LED does not illuminate after switching on the ignition.

Infotainment System

| | |
|------------------------------|----|
| Introduction..... | 62 |
| Updating The System..... | 62 |
| Customization..... | 63 |
| Smartphone Station..... | 63 |
| Navigation..... | 64 |
| Profiles..... | 64 |
| First Steps..... | 65 |
| Steering Wheel Controls..... | 65 |
| Applications..... | 66 |
| Voice Commands..... | 66 |
| Radio */ Media..... | 67 |
| Navigation..... | 69 |
| Connectivity..... | 70 |
| Mirror Screen®..... | 71 |
| Media..... | 73 |
| Phone..... | 73 |
| Settings..... | 74 |
| Help..... | 75 |

Introduction

Note

The functions and settings described vary according to the version and configuration of the vehicle, and according to the country of sale.

Warning

Drive safely at all times. Only operate the Infotainment system if the traffic conditions allow a safe usage. If in doubt, stop the vehicle and operate the Infotainment system while the vehicle is stationary.

Warning

The usage of a navigation app does not release the driver from the responsibility for a correct, vigilant attitude in road traffic. Always follow the applicable traffic rules.

Radio reception

Radio reception may be disrupted by static, noise, distortion or loss of reception due to:

- changes in distance from the transmitter

- multi-path reception due to reflection
- shadowing

Theft Deterrent Feature

The Infotainment system is equipped with an electronic security system for the purpose of theft deterrence. The Infotainment system therefore functions only in your vehicle and is worthless to a thief.

Updating The System

Note

Managing devices remotely and remote updating of software and firmware.

Being an integral part of the service used to provide connected services contract(s), the required management of devices as well as the required updating of the software and firmware associated with the aforementioned connected service will be carried out remotely, in particular using "Over the Air" technology.

To do this, a secure connection via radio network is established between the vehicle and the Manufacturer's device management server each time the ignition is switched on, when a mobile telephone network is available.

Depending on the vehicle's equipment, the connection configuration must be set to "Connected vehicle" to enable the connection to the radio network. Irrespective of a valid subscription to a connected service, the remote management of devices relating to or connected with the security of devices, and the updating of software and firmware, will be carried out when necessary in order to comply with a legal requirement applicable to the Manufacturer (e.g. the applicable law in terms of product liability, the regulations governing e-call) or when necessary to protect the respective vital interests of the vehicle's users and passengers. The establishment of a secure connection via radio network and the corresponding remote updates are not affected by the privacy settings and are intended to be carried out after being initialised by the user in response to a related notification. The system can notify the receipt of an update when it is connected to an exterior Wi-Fi network or a mobile telephone network. Large updates are downloaded only via the Wi-Fi network. The availability of an update is notified on the screen at the end of the journey

with an option of immediate installation or postponement of installation. The installation time is variable and can take several minutes with a maximum of about 30 minutes. A notification will give an estimate of the duration and a description of the update. Update information is available via the settings.

Press 

In the list, select the update tab.

 This button allows you to change the authorization for automatic downloading of updates via an exterior Wi-Fi network.

Warning

For safety reasons and because it requires sustained attention on the part of the driver, the installation must be carried out with the ignition on but without starting the engine. The installation cannot be carried out in the following cases:

- engine running
- emergency call in progress
- insufficient battery level
- when charging for electric vehicles

If an update has failed or has expired, contact a dealer or a qualified workshop.

Note

The Manufacturer does not charge for the use of this service. However, the use of Wi-Fi and/or mobile phone networks by the mobile device may incur extra charges if the data allowance included in the contract is exceeded.

Any associated costs will be billed to the user by the relevant mobile phone operator.

Customization

Press and hold the screen from one of the system's home pages.

Or

Press 

In the list, select the customization tab.

Press the display field.

A page divided into 2 parts is displayed.

Press  at any time to leave this page.

Smartphone Station

The Smartphone Station is operated via the MyOpel App on an external device, such as a mobile phone, that is connected to the vehicle via Bluetooth. The following menus can be selected:

- Library: browse playlists, artists, albums, tracks and directories.

- Phone: make and receive phone calls.
- Web radio: select from various web radio stations.
- Tuner radio: manually search for radio stations.
- Settings: personalize system settings.

Installation of the external device

Pull the slide holder to the right, insert the mobile device into the support and fix it with the slide holder.

Pairing a mobile device

Automatic pairing

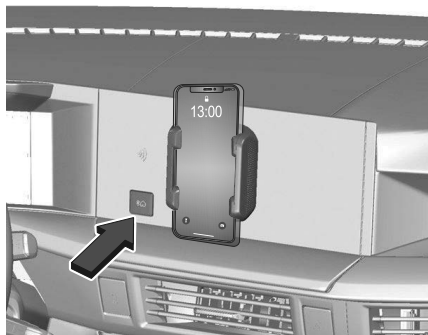

Push the Bluetooth button of the smartphone station to enable bluetooth visibility.

Open the Bluetooth menu on the mobile device and activate the scan function.

The system will automatically search for new devices.

The LED in the button flashes green to indicate that the Smartphone Station has been detected.

If the Bluetooth connection is ready, the LED in the button illuminates green and the smartphone station will be visible as MyOpel in the Bluetooth menu.

Manual pairing

If the system does not find the mobile device automatically, press and hold the Bluetooth button.

The LED in the button flashes green to indicate that the Smartphone Station is visible. If the Bluetooth connection is ready, the LED in the button illuminates green and the vehicle identification number will be visible in the Bluetooth menu.

Navigation

Profiles

Press .

In the list, select . The screen displays a default profile and allows you to create and personalize several new

profiles with or without an associated mobile device.



The profile has a default display with the possibility of editing and/or returning it to its initial configuration. This profile cannot be deleted.



Each profile created can be associated with a mobile device of your choice connected via Bluetooth®; the Bluetooth® function of the mobile device has to be activated first.

If a profile is not connected to the mobile device, the last profile used will be highlighted.

Creating a new profile allows you to personalize:

- Language, units, privacy settings.
- Screen configuration, appearance, smart touch.
- Audio settings, favorite radio stations.
- Lighting, interior ambience ⇨ page 76
- Navigation history, favorite points of interest (POIs), navigation settings.
- Some driving aids and the list of favorites.

















To delete a profile, select it from the list of profiles then press the bin.

First Steps

The system allows to interact with a variety of features using the touch screen, the steering wheel controls and voice commands. By integrating a Bluetooth® enabled smartphone, the system provides easy interaction with audio, multimedia, navigation and smartphone's compatible applications. The touch screen gives a quick access to all of the entertainment, communication and navigation options.



-  Displays the settings.
-  Displays the navigation menu.
-  Displays the phone menu.

-  Displays the phone projection screen when phone projection is active
-  Displays the radio menu.
-  Displays the home screen.
-  Connects or disconnects a device with the Bluetooth function.
-  Switches the system on / off.
-  Adjusts the volume of connected device.
-  Mutes the sound.
-  Displays the Apple CarPlay app on the Info Display.
-  Displays the Android Auto app on the info Display.
-  Changes the media source.
-  Displays the audio menu.

Power on/off and Screen on/off

When button  is pressed, a page appears with the date and time and the option to select the shutdown of the audio system or to switch off the touch screen.

Power Off

Press and hold button . The touch screen will turn off and the sound will cut out.

Screen Off

Press button . The touch screen will turn off and only the sound from the current audio source remains active. In all cases, touch anywhere on the screen to turn it on.

Steering Wheel Controls



SRC SRC (short press): change media sources.

 Increase volume/ Decrease volume.



Mute/Unmute the sound: short press in the center.

- ▲ **Move up:** validate a selection; movement in the lists.
- ▼

Radio: automatic search for the next station (in the list of radio stations sorted by name or by frequencies).

Media: next track.

Phone (short press): accept the incoming call.

- ▲ **Move down:** validate a selection; movement in the lists.
- ▼

Radio: automatic search for the previous station (in the list of radio stations sorted by name or by frequencies).

Media: previous track.

Phone (short press): refuse the incoming call; hang up the call in progress.



Voice control (short press): voice commands of the smartphone connected using Bluetooth® or Mirror Screen® (Siri with Apple® CarPlay®/Google Assistant with Android Auto) via the system.

Applications

Applications

Radio



Select a radio station (FA, AM and DAB) Infotainment, applications.

Media



Select a media source (USB, iPod, Bluetooth®, Apple CarPlay® and Android Auto).

Phone



Connect a mobile phone via Bluetooth®, make and receive calls, access the phonebook, call log.

Navigation



Configure guidance and choose a destination.
Use the services available in real time depending on equipment.

Settings



Main settings for the touch screen, audio system and GPS.

Voice Commands

The voice recognition setting is available with the mobile telephone network and according to the language previously selected in the mobile phone.



When voice commands are activated, say your command after the audible signal.

For commands in several stages, interaction takes place with the system to complete the initial request.

Some commands self-validate after seven seconds.

If the system has not taken your command into account, it will indicate this by a voice message and an onscreen display.

Note

Voice Assistant/Data Usage

Vehicle's location and voice recordings are not concerned;
only textual transcriptions of your conversations with the voice assistant are kept after to be pseudonymised.

Opening voice commands



Voice commands can be used on any screen page, provided there are no

other sources which take priority in use (reverse, emergency or assistance call, phone call, other mobile phone voice recognition already launched).

 Choice of opening voice recognition:

- Press the  located on the steering wheel.

Or

- Say "**Siri**" or "**OK Google**" depending on mobile phone type.

Note

To ensure that voice commands are always recognized by the system, please follow these recommendations:

- Use natural language in a normal tone without breaking up words or raising your voice.
- After opening voice recognition with the steering wheel control or the button on the touch screen, always wait for the "beep" (audible signal) before talking. No "beep" sounds when voice recognition is opened using " OK Iris ".
- For optimal operation, it is recommended that you close the windows to avoid any external interference, and switch the ventilation off.

- Before speaking the voice commands, ask the other passengers not to speak.

 Voice command example for radio and media:

"I want to listen to Michael Jackson"

 Voice command example for telephone:

"Call Matthew's mobile"

" Call 0113 345 9869"

"Call Jonathan"

Note

If there is no mobile device connected by Bluetooth®, a pop-up window appears informing that no device was connected and that the voice session will be closed.

 Voice command example for navigation:

"Navigate home"

"Navigate me to gabrielle's house"

"Search for public parking nearby"

Note

Depending on the country, give destination (address) instructions in the language configured for the system.

Radio */ Media

Changing the source (Media to Radio)

Press  to display the media main page.

Press  to switch to display the radio main page.

This icon is displayed.

Audio Settings

For more information on settings, refer to the corresponding section. ⇨ page 74

Changing the waveband

Press  to display the main page.

Press **FM**, **AM** or **DAB** button to change the waveband, according to the country of sale.

Note

18 radio stations can be preset on each waveband.

Note

Radio reception may be affected by the use of electric equipment not approved by the Brand, such as a charger with USB socket connected to the 12 V socket.

The exterior environment (e.g. hills, buildings, tunnels, basement car parks) may block reception, including in RDS

mode. This phenomenon is normal in the propagation of radio waves and does not indicate any malfunction of the system.

Selecting a radio station

Press  to display the main page.

Press  to start/stop the scan for available radio stations.

The radio stations found are displayed in the list of favorite radio stations.

Or

▲ Press one of the buttons to perform an automatic search for the previous/next radio stations. The tuner stops at the first radio station found.

Or

▲ Press one of the buttons to perform a manual search for the lower/higher frequency. On each press, the tuner decrements/ increments by one frequency step (e.g. 0.05 MHz on FM; 1 KHz on AM). The value of the frequency step depends on the country of sale. In the last two cases, it is possible to manually store each radio station found.

▲
▼ If necessary, press one of the buttons to navigate in the list of favorite radio stations.

Press and hold down the desired preset number. A new memory entry replaces the previous one.

Recalling a stored radio station

Press  to display the main page.

Press  to display the list of available radio stations. Select a radio station in the list.

Press  to display the main page.

Press **FM**, **AM** or **DAB** button to change the waveband, according to the country of sale.

- ◀ If necessary, press one of the buttons to navigate in the list of favorite radio stations.
- ▶

1 2 3... Press the desired preset number.

DAB (Digital Audio Broadcasting) radio

Note

Digital radio provides higher quality reception and also the graphical display of current information on the radio station being listened to. The various "multiplexes/ensembles" offer a choice of radio stations organised in alphabetical order. The volume may be higher when receiving traffic alerts or news.

DAB/FM station tracking

Note

"**DAB**" does not cover 100% of the territory. When the digital radio signal is poor, the "**AF**" (alternative frequency) option enables to continue listening to the same station by automatically switching to the corresponding "**FM**" analogue station (if there is one).

Note

When the system switches to analogue station, there is a delay of a few seconds with sometimes a change in volume. When the digital signal quality is restored, the system automatically changes back to "**DAB**".

Note

If the "**DAB**" radio station is not available, the sound cuts out when the digital signal quality becomes poor and the "**AF**" alternative frequency is crossed out.

Presetting a station

Select a station.

 Press the "**Media**" application. In the list, select the "**Player**" tab.

 Press the "**Radio Favorites**" button.

 Storing takes place via a short or long press on one of these buttons, or a long press on an existing favorite radio station, which will be replaced.

 Press this button to return to the previous page.

Navigation

Navigation home page

(Depending on equipment)

Press  to display the navigation main page.

Press  to display the shortcut menu for the various options.

Press  to display the search page (address, name or point of interest (POI)).

Press  to zoom in/out, or use two fingers on the screen.

Press  to display the 3D mode.

Main Menu

Access

Press  Navigation to display the main page.

Options Settings

Press  to display the shortcut menu for the various options.

Choosing a new destination

Press  to display the search page. Click on the search or address field to enter an address or a name. An alphanumeric keypad appears. Enter the city, street and number and confirm by pressing the respective proposals displayed.

Press  to start the guidance.

Choosing one of the last destinations

Press  to display the search page. Scroll down for the last desired destination and confirm by pressing on it. Or



Press  to obtain more destinations. Select the desired destination and confirm by pressing on it.

Press  to start the guidance.

Choosing one of My Places

Press  to display the search page.

Press  to obtain private destinations.

Select  or  and confirm by pressing on it.

Press  to start the guidance.

Choosing a point of interest (POI)

Press  to display the search page. Select the type of POI by pressing on it (e.g. Parking, Service station). A list of the corresponding POI selected appears.

Or

Press  to obtain POI around the vehicle position.

Select the POI to visit and confirm by pressing on it.

Press  to start the guidance.

Choosing a point on the map

Press  to display the search page. Explore the map by dragging it with fingers. Zoom the desired area by pressing on "+" button. Select the destination by pressing the map.

Press  to start the guidance.

Connectivity

Information Bluetooth®

Warning

For safety reasons and because they require continued attention on the part of the driver, pairing operations between the Bluetooth® mobile phone and the vehicle's Bluetooth® hands-free system must be carried out with the vehicle stationary and the ignition switched on.

Note

Make sure that the mobile phone's Bluetooth® function is activated and "visible to all". In the event of a malfunction, it is advisable to deactivate and then reactivate the Bluetooth® function from the mobile phone.

Note

Once back in the vehicle, if the last connected mobile phone is present again (Bluetooth® function activated), it is automatically recognized and, within about 30 seconds of starting up, the pairing is automatically carried out. The streaming function allows you to listen to the audio stream coming from the mobile device connected via USB, iPod®, Bluetooth® or Mirror Screen®.

First adjust the volume on the mobile device (to a high level).

Then adjust the volume of the system.

If playback does not start, it may be necessary to start the audio playback from the mobile device.

The control operates via mobile device or via the buttons on the touch screen of the infotainment system.

Note

Once connected in streaming mode, the mobile device is considered to be a media source.

Pairing a Bluetooth® mobile device

Note

The services available depend on the network, the SIM card and the compatibility of the Bluetooth® mobile devices used. Consult the phone user guide, the service provider and the OEM portal to check which services are available.

Note

To complete the pairing, whichever procedure is used (from the phone or from the system), ensure that the code is the same in the system and in the phone. If the pairing procedure fails, we recommend deactivating and then reactivating the Bluetooth® function on the phone and deleting any OPEL name present in the devices list.

Note

Depending on phone type, you may be prompted to accept the transfer of contacts.



Procedure from the mobile phone

In order to make the system Bluetooth® visible, first open  on the system and activate the Bluetooth® function.



From the Bluetooth® menu on your phone, select the system name from the list of detected devices. In the system, accept the connection request from the phone and follow the instructions on the phone and system touch screen.

Procedure from the system

Press  to display the main page. In order to make the system Bluetooth® visible, first open  on the system and activate the Bluetooth® function.

Managing paired mobile devices

To connect or disconnect a paired phone and switch to Android Auto or Apple CarPlay®:

Press  to display the main page

Press  to display the paired devices list

Press  to delete the desired paired device.

Information - Wi-Fi

Note

The Wi-Fi connection including credential sharing with the user's smartphone happens automatically after successful Bluetooth® connection with a wireless supported smartphone.

Note

The Wi-Fi connection can only be used for Android Auto or Apple®CarPlay® wireless connection.

Note

The Wi-Fi network uses the 5 GHz frequency. Some smartphones may not support this feature.

Information - Mirror Screen®

Note

Synchronizing a mobile device enables users to display applications that support the mobile device Android Auto or Apple CarPlay® technology on the vehicle's screen. For Apple CarPlay® technology, the Apple CarPlay® function must first be activated on the mobile device. In all cases, the mobile device must be unlocked, to enable the communication process between the mobile device and

the system to function (at first connection only). As principles and standards are constantly changing, we recommend keeping the mobile device operating system up-to-date, together with the date and time on the smartphone and the system.

Refer to your mobile device for Android Auto or Apple CarPlay® settings.

Note

For the list of suitable mobile devices, visit the Android Auto and Apple CarPlay® websites:

<https://www.android.com/auto/>

<https://www.apple.com/in/ios/carplay/>

Warning

Stop the vehicle before connecting Android Auto or Apple®CarPlay® and follow the instructions on your mobile device.

Note

On connecting the USB cable, the Android Auto or Apple CarPlay® function deactivates the system's Bluetooth® mode.

Caution

It is recommended to use the original USB cable of the mobile device.

To protect the system, do not use a USB hub.

Mirror Screen®

Apple CarPlay® connection

Note

The Apple CarPlay® function requires the use of a compatible mobile device and compatible applications.

Connecting Apple CarPlay® mobile device can be carried out either by an USB cable or using a wireless connection.

USB Connection

Note

Only one USB port enables the Mirror Screen® connection by Apple®CarPlay®. For more information on USB port, refer to the corresponding section. ⇨

Connect the USB cable.

The mobile device charges when connected by an USB cable.

 Activate the Bluetooth® function on the smartphone.

From the Home page, press  and then activate the Bluetooth® function. As soon as a Bluetooth® device offering Apple CarPlay® is connected, Apple

CarPlay® is automatically available, provided a wide-band communication channel (USB) is connected.

From the Home page, press  to display the Apple CarPlay® interface.

Note

When the USB cable is disconnected and the ignition is switched off and then back on, the system will not automatically switch to other mode; the source must be changed manually.

Wireless connection



First activate the Bluetooth® and Wi-Fi functions on the smartphone.

From the Home page, press  and then activate the Bluetooth® and Wi-Fi functions. As soon as a Bluetooth® device offering Apple CarPlay® is connected, Apple CarPlay® is automatically available, provided a wide-band communication channel (Wi-Fi) is connected.

As soon as the wireless connection is established, press  to display the Apple CarPlay® interface.

Note

There may be a pause before applications become available, depending on the quality of the network and performances of the mobile device.

For wireless Apple CarPlay®, subsequent automatic connection of the mobile device requires activation of Bluetooth® and Wi-Fi on your device.

Android Auto connection

Note

Ensure the latest Android Auto application is available on your mobile device. If not, install it via "Play Store". The Android Auto function requires the use of a compatible mobile device and compatible applications. Android Auto connection can be carried out either by an USB cable or using a wireless connection.

USB connection

Note

Only one USB port enables the Mirror Screen® connection by Android Auto. For more information on USB port, refer to the corresponding section ⇨ Connect the USB cable. The mobile device charges when connected by an USB cable.

 Activate the Bluetooth® function on the mobile device.

From the Home page, press  and then activate the Bluetooth® function. As soon as a Bluetooth® device offering Android Auto is connected, Android Auto

is automatically available, provided a wide-band communication channel (USB) is connected.

From the Home page, press  to display the Android Auto interface.

Note

A validation procedure on the mobile device has to be followed for the first connection, with the vehicle stationary.

Wireless connection



First activate the Bluetooth® and Wi-Fi functions on the mobile device.

From the Home page, press  and then activate the Bluetooth® and Wi-Fi functions. As soon as a Bluetooth® device offering Android Auto is connected, Android Auto is automatically available, provided a wide-band communication channel (Wi-Fi) is connected.

As soon as the wireless connection is established, press  to display the Android Auto interface.

Note

There may be a pause before applications become available, depending on the network quality and the mobile device performances. For wireless Android Auto, subsequent automatic connection of the mobile

device requires activation of Bluetooth® and Wi-Fi on the mobile device. As soon as the wireless connection is re-established, press  to display the Android Auto interface.

Media

Changing the source (Radio to Media)

Press  to display the main page.

Press  to switch to the media main page.

This  is displayed.

Audio Settings/Devices Settings

For more information on settings, refer to the corresponding section. ⇨ page 74

Changing the media source

Press  to display the main page. Press the respective button to change the media source, according to the country of sale.

Bluetooth® audio streaming

The streaming function allows you to listen to the audio stream coming from the mobile device connected via USB, iPod®, Bluetooth® or Mirror Screen®.

First adjust the volume on the mobile device (to a high level). Then adjust the volume of the system. If playback does not start, it may be necessary to start the audio playback from the mobile device.

Control is from the mobile device or by using the system's touch buttons.





Note

Once connected in streaming mode, the mobile device is considered to be a media source.

Playing a track

Press  to display the main page.

Once the portable device is connected, browsing through the files is possible by pressing this button. Some information appears, such as the title, artist, album and duration of the track currently playing.

-  Short press: go to the previous/next track.
-  Track playback/pause.
-  Repeat the current title or the list of selected titles.
-  Random track playback.

Note

To fast-forward or rewind a track, drag the playback progress slider at the bottom of the page.

Phone

Warning

Depending on the legislation in force in the country, hand-held mobile devices are forbidden when driving. To make a call directly from the mobile device, the vehicle must first be safely stopped.

Note

While driving, it is always possible to use the steering wheel controls or voice commands to start or end a call.

Receiving a call

An incoming call is announced by a ring and a superimposed display in the screen.

To accept the incoming call:

Press .

Or

Press  on the steering wheel.

Once the call has been picked up, a screen appears with the following information:

- the caller's mobile phone number.
- the call status (incoming/outgoing, in progress, conference, ended).
- the call duration.

To refuse the incoming call/ hang up the call in progress:

Press .

Or

Press  on the steering wheel.

Making a call

Calling a new number

Press  to display the main page.

Press  to display the numeric keypad. Enter the mobile phone number using the numeric keypad.

Press  to launch the call.

Calling a contact from the phonebook

Press  to display the main page.

Press  to display the phonebook. Select the desired contact name in the list

Or

Press  to search the contact name. Enter your first letters; the corresponding contact names appear.

Select the desired contact name in the list.

Press  to launch the call.

Calling a number from the call log

Press  to display the main page.

Press  to display the call log. Select the desired last number in the list.

Press  to launch the call.

Call options

Call in progress

During a phone conversation, a screen appears with the following options:

Mute/Unmute

Press  to mute/unmute the micro of the system.

Handset/Hands-free

Press  to transfer the call from the system to the mobile phone and vice versa.

Hold/Retrieve

Press  to hold/retrieve the call.

End call

Press  to hang up the call.

Add

Press  to add a new call (Conference call).

Keypad

Press  to display the numeric keypad.

Settings

General Settings

Press  to display the main page.

Press the general tab  to access the various items to be set.

- **Language:** to choose the system display language from the list.
- **Factory Reset:** to return to factory default system.
- **Software Update:** to update the system by USB device and to see the current software/hardware versions.

Display Settings

Press  to display the main page.
Press the display tab to access the various items to be set:

- **Brightness:** to adjust the touch screen brightness using the- and + buttons or by moving the slider. Only available in night display, when vehicle lights are on.

Devices Settings

Press  to display the main page.
Press the devices tab to access the various items to be set:

- **Bluetooth:** to turn on/off the Bluetooth visibility of the system.
- **Wi-Fi:** to activate/deactivate the Wi-Fi network of the system.
- **Scan for devices:** to select a mobile device to be connected (USB,Bluetooth®, Apple CarPlay® or Android Auto).
- **Device list:** to view the previously paired mobile device and connect or delete a device.

Audio Settings

Press  to display the main page.

Press **Audio** to access the various items to be set:

- **Radio Settings:** to activate/deactivate the radio functions (e.g. Radio Data System (RDS), Alternative Frequency (AF), Traffic Announcement (TA)).
- **Balance/Fader:** to adjust the left/right (Balance) and front/rear (Fader) sound distribution.
- **Equalizer:** to adjust the treble, mid and bass sound levels and to activate/deactivate the loudness and speed dependent volume control functions.
- **Volume:** to adjust the volume according to each sound source.

Clock Settings

Press  to display the main page.
Press the clock tab to access the various items to be set:

- **Date and Time:** to manually adjust the date and time.
- **Format:** to choose the date and time display format.

Date and Time

Select **Set Date**.
Adjust the day, month and year using the up and down arrows.
Press **OK** to validate.

Select **Set Time** Adjust the hours and minutes using the up and down arrows.
Press **OK** to validate.

Format

Select **Date Format:** **DD/MM/YYYY**, **MM-DD-YY** or **YYYY-MM-DD**.
Select **Time Format:** **24#hour** or **12#hour**.

Help

Press .
Select the tab for user manual to consult the vehicle's owner's manual.
Or
In the list, select the tab for tutorials to watch explanatory videos for a quick start on screen management, certain driving aids and voice recognition.

Lighting

| | |
|--------------------------------------|----|
| Exterior Lighting..... | 76 |
| Light Switch..... | 76 |
| Tail Lights..... | 76 |
| Automatic Light Control..... | 77 |
| High Beam..... | 77 |
| High Beam Assist..... | 77 |
| Headlight Range Adjustment..... | 78 |
| Headlights When Driving Abroad..... | 78 |
| Daytime Running Lights..... | 78 |
| Headlight Flash..... | 78 |
| Hazard Warning Flashers..... | 78 |
| Turn Lights..... | 79 |
| Front Fog Lights..... | 79 |
| Rear Fog Light..... | 79 |
| LED Headlights..... | 80 |
| Parking Lights..... | 80 |
| Misted Light Covers..... | 81 |
| Interior Lighting..... | 81 |
| Instrument Cluster Illumination..... | 81 |
| Interior Lights..... | 81 |
| Reading Lights..... | 81 |
| Lighting Features..... | 82 |
| Centre Console Lighting..... | 82 |
| Entry Lighting..... | 82 |
| Exit Lighting..... | 82 |
| Vehicle Locator Lighting..... | 82 |
| Battery Discharge Protection..... | 82 |

Exterior Lighting

Light Switch

⚠ Warning

Do not look directly into the LED headlights. Risk of eye damage.

Depending on version:

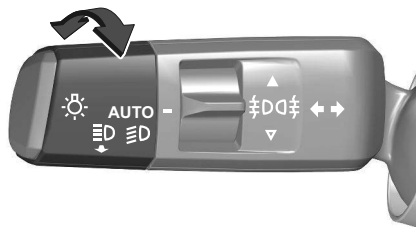

Turn the light switch:

- AUTO** automatic light control switches automatically between daytime running light and headlight
-  low beam / high beam

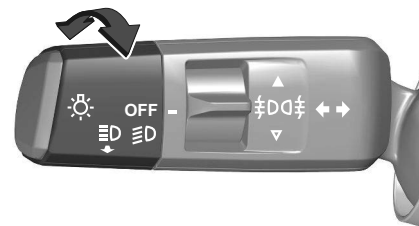

Turn the light switch:

- OFF** Turn off lights
-  low beam / high beam

Control indicator ⇔ page 45

Tail Lights

Tail lights are illuminated together with low / high beam and sidelights.

Automatic Light Control

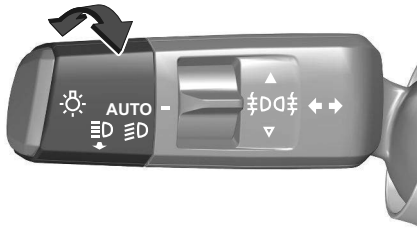

When the automatic light control function is switched on, the system switches between daytime running lights and headlights automatically depending on the external lighting conditions and information given by the wiper system.

Automatic headlight activation

Turn the switch in position: **AUTO**
 During poor lighting conditions the headlights are switched on. Additionally, headlights are switched on if the windscreen wipers have been activated for several wipes.

High Beam

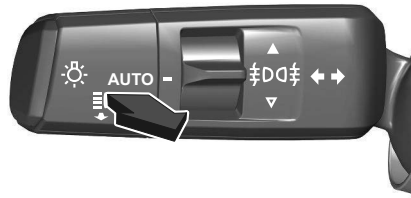

To activate or deactivate the high beam, pull the lever two times.



High Beam Assist

The system switches from low beam to high beam and vice versa to prevent glaring. Once activated, high beam assist remains active and switches high beam on and off depending on surrounding conditions. The latest setting of the high beam assist will remain set after the ignition is switched on again.

Activation

Turn the switch in the position: **AUTO**
 Depending on version: The high beam assist can be activated via the vehicle settings menu on the cluster.

High beam is switched on automatically in dark surroundings at a speed above 45 km/h. High beam is switched off at a speed below 35 km/h, but high beam assist remains active.

The green control indicator  illuminates continuously when the high beam assist is activated, the blue  illuminates when high beam is on.

Deactivation

Depending on version: The system can be deactivated via the vehicle settings menu on the cluster.

Vehicle customization ⇒ page 59

Fault

If the system does not work properly or is not available, e.g. during the initialization,

 illuminates on the cluster.

It is accompanied by a message indicating that the sensors or the camera may be covered. Stop the vehicle and check, if these needs to be cleaned.

If  still illuminates after cleaning the camera, consult a workshop.

If  illuminates on the cluster after the engine has been switched off and then restarted, consult a workshop.

Headlight Range Adjustment



To adapt headlight range to the vehicle load to prevent dazzling: turn thumb wheel to required position.

- 0 : front seats occupied
- 1 : all seats occupied
- 2 : all seats occupied with load compartment laden
- 3 : driver's seat occupied and load compartment laden
- 4 : not used
- 5 : not used
- 6 : not used

Headlights When Driving Abroad

When driving in countries where traffic drives on the opposite side of the road, the headlights do not have to be adjusted.

Contact your dealer or a qualified workshop.

Daytime Running Lights

Daytime running lights increase visibility of the vehicle during daylight.

⇒ page 77

Headlight Flash



Pull to activate the headlight flash.
Pull to deactivate the high beam.

Hazard Warning Flashers



Press the button to operate.

When braking in an emergency, the hazard warning flashers are switched on automatically, depending on the force of deceleration. They are switched off automatically, as soon as the vehicle is accelerated again.

Turn Lights

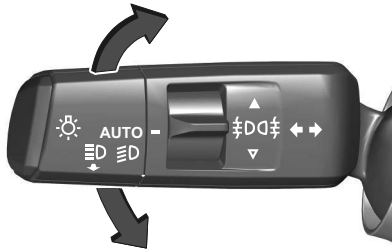

- up** right turn light
down left turn light

A resistance point can be felt when moving the indicator lever. Constant flashing is activated when the indicator lever is being moved beyond the resistance point. It is deactivated when the steering wheel is moved in the opposite direction or indicator lever is manually moved back to its neutral position. After 20 seconds the volume of the audible signal will increase if the speed is above 80 km/h. Activate temporary flashing by holding the indicator lever just before the

resistance point. Turn lights will flash until indicator lever is being released. To activate three flashes, tap the indicator lever briefly without passing the resistance point.

Front Fog Lights

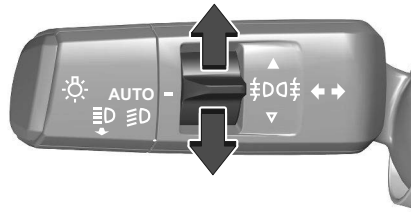

Push the switch up once to switch on the front fog lights.
 Push the switch down once to switch off the front fog lights.
 Light switch in position **AUTO**: switching on front fog lights will switch headlights on automatically.
 The fog lights should only be used in very bad visibility conditions like fog, snow or heavy rain.

Rear Fog Light

Depending on version:

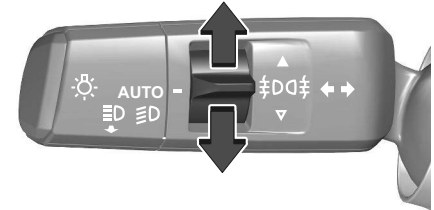

Push the switch up to switch on the rear fog light.
 Push the switch down to switch off the rear fog light.

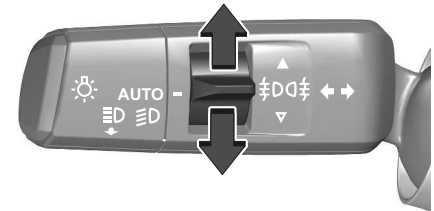

Push the switch up twice to switch on the rear fog light.

Push the switch down twice to switch off the rear fog light.

Light switch in position **AUTO**: switching on rear fog light will switch headlights on automatically.

The vehicle rear fog light is deactivated when towing a trailer or a plug is connected with the socket, e.g. when a bicycle carrier is used.

LED Headlights

Eco-LED and uplevel-LED headlights for low and high beam ensure better visibility under all conditions. Uplevel LED headlights include the following functions:

- cornering lights
- high beam assist ⇨ page 52
- automatic headlight levelling

Cornering light

Light switch must be in position **AUTO**.



When turning off, depending on the steering angle and the turn light, particular LEDs are triggered which illuminate the direction of travel. It is activated up to a speed of 40 km/h.

Reverse parking function

To assist driver's orientation when parking, both cornering lights and reversing light illuminate when headlights are activated and reverse gear is engaged. They remain illuminated for a short time after disengaging reverse gear or until driving faster than 7 km/h in a forward gear.

Automatic headlight levelling

To prevent oncoming traffic from being dazzled, headlight levelling is automatically adjusted.

Fault in LED headlight system

When the system detects a failure in the LED headlight system, a warning is displayed on the cluster.

Parking Lights

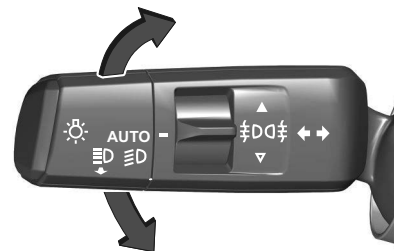

When the vehicle is parked, the parking lights on one side can be activated:

1. Switch off the ignition.
2. Move the lever all the way up (right parking lights) or down (left parking lights).

Confirmed by the corresponding turn light control indicator.

Note

The parking lights stay on, until ignition will be switched on again. To avoid

battery drainage, do not use them for an extended period.

Misted Light Covers

The inside of the light housing may mist up briefly in poor, wet and cold weather conditions, in heavy rain or after washing. The mist disappears quickly by itself. To help, switch on the headlights.

Interior Lighting

Instrument Cluster Illumination

The brightness of the following lights can be adjusted via the vehicle settings menu on the cluster or the settings app on the Information Display when the exterior lights are on:

- cluster illumination
- Information Display
- illuminated switches and operation elements

Interior Lights

Note

In the event of an accident with airbag deployment the courtesy lights are turned on automatically.

Courtesy lights

Operate rocker switch:

Leave the switch to its middle position:

automatic switching **ON** and **OFF**

Press the switch on the right: **ON**

Press the switch on the left: **OFF**

Front courtesy light



Rear courtesy lights

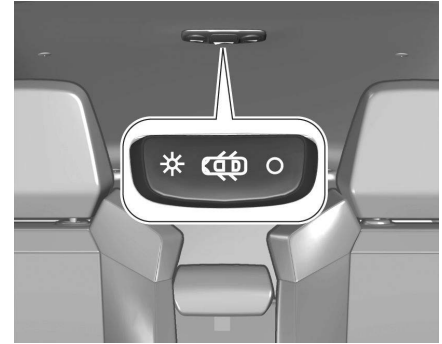

Reading Lights

Operated by pressing the button.

Front reading lights

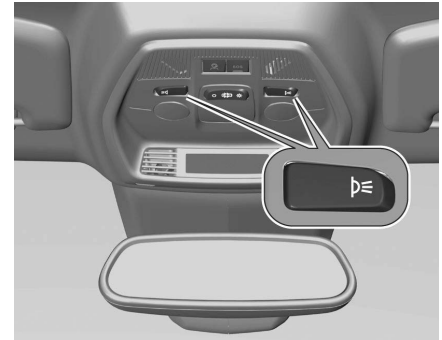

Rear reading lights

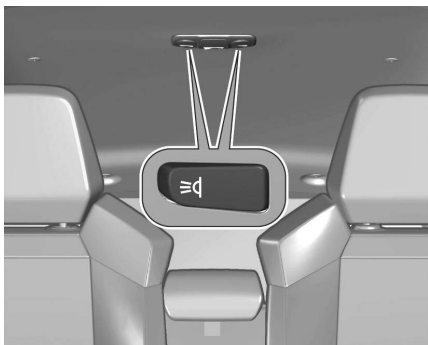

Lighting Features

Centre Console Lighting

A spotlight integrated in the overhead console illuminates the centre console when the headlights are switched on.

Entry Lighting

Welcome lighting

Some or all of the following lights are switched on for a short time by unlocking the vehicle:

- headlights
- tail lights

- number plate lights
- centre console lighting
- interior lights

The number of activated lights depends on the surrounding light conditions. The lighting switches off immediately when the ignition is switched on. Activation, deactivation and the duration of the function are set via the vehicle settings menu on the cluster. The following lights will additionally switch on when the driver's door is opened:

- illumination of some switches
- cluster
- door pocket lights

Exit Lighting

The following lights are switched on if the ignition is switched off:

- headlights
- interior lights
- centre console lighting

They will switch off automatically after a delay.

This function works only in the dark.

Activation, deactivation and the duration of the function are set via the vehicle settings menu on the cluster. The function can also be activated or deactivated by pulling the lever with the ignition off.

Vehicle Locator Lighting

This function allows to locate the vehicle, e.g., in weak lighting conditions using the remote control.

The headlights come on and the turn lights flash for ten seconds.

Battery Discharge Protection

To prevent discharge of the vehicle battery when the ignition is switched off, some interior lights are switched off automatically after some time.

Climate Control

| | |
|---|----|
| Climate Control Systems..... | 83 |
| Electronic Air Conditioning System..... | 83 |
| Manual Air Conditioning System..... | 85 |
| Auxiliary Heater..... | 87 |
| Air Vents..... | 87 |
| Adjustable Air Vents..... | 87 |
| Fixed Air Vents..... | 88 |
| Maintenance..... | 88 |
| Air Intake..... | 88 |
| Air Conditioning Regular Operation..... | 88 |
| Service..... | 88 |

Climate Control Systems

Electronic Air Conditioning System

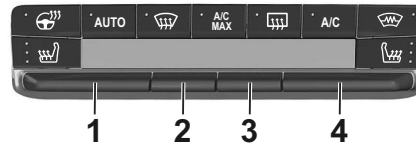

- 1 Temperature
- 2 Air distribution
- 3 Recirculation of interior air
- 4 Fan speed



Heated steering wheel

AUTO Automatic mode



Demisting and defrosting windows



Maximum air conditioning



Heated rear window ⇨ page 15 and exterior mirrors ⇨ page 11

A/C

Air condition on/off



Heated windscreen ⇨ page 13



Heated seat ⇨ page 19

Automatic Air Conditioning

In automatic mode, temperature, fan speed and air distribution are regulated automatically.

Press **AUTO** to switch on air conditioning.

The LED in the button illuminates to indicate activation. Air conditioning is only functional when the engine is running.

Press **AUTO** again to switch off air conditioning.

Temperature Adjustment

Push the button 1 up to increase or down to decrease the temperature.

The selected temperature is indicated in the status bar.



Air Distribution Adjustment

Pushing button **2** successively directs the air flow towards:

- to windscreen, front door windows and footwell
- footwell
- to head area via adjustable air vents, front door windows and to footwell
- to windscreen, head area via adjustable air vents, front door windows and to footwell
- to head area via adjustable air vents and front door windows
- to windscreen and front door windows (demisting or defrosting)

Maximum Air Conditioning

Activate maximum cooling with one push on . The function sets temperature as low as possible and adjusts distribution to all air vents. In addition, it sets air flow to maximum and activates air recirculation.

Press  to switch on the function. The LED in the button illuminates to indicate activation. Press  again to switch off the function.

Recirculation Of Interior Air

The recirculation of interior air allows the passenger compartment to be isolated

from polluted air in areas of heavy traffic and inside tunnels.

The intake of exterior air helps to avoid and eliminate misting of the windscreen and the side windows.

Note

When required, this function also allows faster heating or cooling of the air in the passenger compartment.

Press button 3 to recirculate the interior air or allow the intake of exterior air.

Warning

The exchange of fresh air is reduced in air recirculation mode.

In operation without cooling, the air humidity increases, so the windows may mist up from inside.

The quality of the passenger compartment air deteriorates, which may cause the occupants to feel drowsy.

Air Conditioning On / Off

The air conditioning system is designed to operate effectively in all seasons, with the windows closed:

- It lowers the temperature in summer.
- It increases the effectiveness of the demisting, in winter, above 3°C.

Press **A/C** to switch on air conditioning. The LED illuminates to indicate activation. Air conditioning is only functional when the engine is running and fan is switched on.

Press **A/C** again to switch off air conditioning.

Note

To obtain cool air more quickly, enable the interior air recirculation for a brief period. Then return to the intake of exterior air.

The air conditioning system cools and dehumidifies (dries) as soon as the outside temperature is slightly above the freezing point. Therefore, condensation may form and drip from under the vehicle.

If no cooling or drying is required, switch off the cooling system for fuel saving reasons.

Activated cooling may inhibit Autostops. Stop-start system ⇨ page 91

Fan Speed

Push the button 4 up to increase or down to decrease the air flow.

The selected air flow is indicated in the status bar.



Demisting And Defrosting Windows

This mode allows the windscreen and side windows to be demisted or defrosted

as quickly as possible. Press  to switch on the function. The LED in the button illuminates to indicate activation.

Press  again to switch off the function. The mode automatically manages the air conditioning, air flow, air intake and distributes ventilation optimally to the windscreen and side windows.

Note

If  is pressed while the engine is running, an Autostop will be inhibited until  is pressed again.

If  is pressed while the engine is in an Autostop, the engine will restart automatically.

Stop-Start system ⇒ page 91





Heated Steering Wheel

Activate the heating by pressing . Activation is indicated by the indicator light in the button.

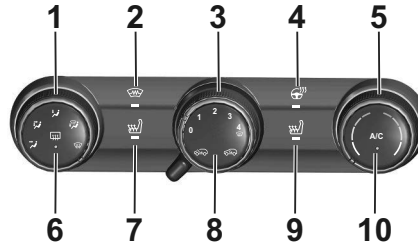
The heating works only when the outside temperature is below 20°C.

Manual Air Conditioning System



- 1 Air distribution
-  Heated windscreen ⇒ page 13
- 3 Fan speed
-  Heated steering wheel
- 5 Temperature
- A/C** Air conditioning on/off
-  Heated seat ⇒ page 19
-  Recirculation of interior air
-  Heated rear window ⇒ page 15 and exterior mirrors ⇒ page 11

Temperature adjustment

Turn knob 1 from blue (cold) to red (hot). Heating will not be fully effective until the engine has reached normal operating temperature.

Fan speed adjustment

Turn knob 3 to adjust the air flow.
clockwise: increase
anticlockwise: decrease

Heated steering wheel

Activate the heating by pressing . Activation is indicated by the indicator light in the button.

The heating works only when the outside temperature is below 20°C.

Air distribution adjustment

Turn knob 5 to select the desired air outlet.



: to head area via adjustable air vents



: to head area via adjustable air vents and to footwell



: to footwell



: to footwell and windscreen



: to windscreen and front door windows

Air conditioning A/C on/off

The air conditioning system is designed to operate effectively in all seasons, with the windows closed:

- It lowers the temperature in summer.
- It increases the effectiveness of the demisting, in winter, above 3°C.

Press **A/C** to switch on air conditioning. The LED in the button illuminates to indicate activation. Air conditioning is only functional when the engine is running and fan is switched on. Press **A/C** again to switch off air conditioning.

Note

To obtain cool air more quickly, enable the interior air recirculation for a brief period. Then return to the intake of exterior air.

The air conditioning system cools and dehumidifies (dries) as soon as the outside temperature is slightly above the freezing point. Therefore, condensation may form and drip from under the vehicle.

If no cooling or drying is required, switch off the cooling system for fuel saving reasons.

Activated cooling may inhibit Autostops. Stop-start system ⇒ page 91

Recirculation of interior air

The recirculation of interior air allows the passenger compartment to be isolated from polluted air in areas of heavy traffic and inside tunnels.

The intake of exterior air helps to avoid and eliminate misting of the windscreen and the side windows.

Note

When required, this function also allows faster heating or cooling of the air in the passenger compartment.

Rotate selector 8 to the right to allow interior air recirculation.

Rotate selector 8 to the left to deactivate air recirculation and allow intake of exterior air.

Warning

The exchange of fresh air is reduced in air recirculation mode.

In operation without cooling, the air humidity increases, so the windows may mist up from inside.

The quality of the passenger compartment air deteriorates, which may cause the occupants to feel drowsy.



Maximum cooling

Briefly open the windows so that hot air can disperse quickly.

Switch on **A/C**.

- Activate interior air recirculation.
- Adjust air distribution to head area.
- Set temperature control to coldest level.
- Set fan speed to highest level.
- Open all vents.

Demisting and defrosting the windows

- Turn knob 3 to position 4: the air flow is maximized towards the windscreen.
- Turn knob 5 to : the air distribution is directed towards the windscreen.
- Set temperature to warmest level.
- Switch on **A/C**, if required.
- Switch on heated rear window .
- Open side air vents as required and direct them towards the door windows

Maximum cooling

Briefly open the windows so that hot air can disperse quickly.

Switch on **A/C**.

- Activate interior air recirculation.
- Adjust air distribution to head area.

- Set temperature control to coldest level.
- Set fan speed to highest level.
- Open all vents.

Temperature preconditioning (for BEV)

The temperature preconditioning allows to heat or to ventilate the vehicle's interior with ambient air.

The temperature preconditioning can be programmed via the Info Display or the MyOpel App.

The operating status of the temperature preconditioning is shown by a LED.

- LED illuminates: A timer has been set.
- LED flashes: The system is operating.

The LED is extinguished at the end of the operation or when the temperature preconditioning is stopped using the remote control.

The temperature preconditioning can be programmed by using the Info Display.

Note

The temperature preconditioning is only activated if the ignition is off and the vehicle is locked.

If the charging level of the high voltage battery is below 30%, the temperature preconditioning is not activated.

When the vehicle is plugged in, battery charging takes precedence over preconditioning.

Consequently, it can only be activated if the battery is charged above a threshold fixed at 80%.

If a recurrent heating / ventilation is programmed and two heating / ventilation procedures are carried out without operating the vehicle, the programming is deactivated.

Setting timer

Note

Several timers can be programmed and saved. It is recommended to programme temperature preconditioning with the vehicle plugged in, in order to optimise the long-term performance of the high voltage battery.

The heating / ventilation procedure starts approx. 45 minutes before the programmed time when the vehicle is plugged in, or 20 minutes before the programmed time when it is not plugged in, and is maintained ten minutes after it.

Auxiliary Heater

Quickheat is an electric auxiliary air heater which automatically warms up the passenger compartment more quickly.

Air Vents

Adjustable Air Vents

At least two air vents must be open while cooling is on.

⚠ Warning

Do not attach any objects to the slats of the air vents. Risk of damage and injury in case of an accident.

Air vents on the instrument panel

Outer air vents on instrument panel

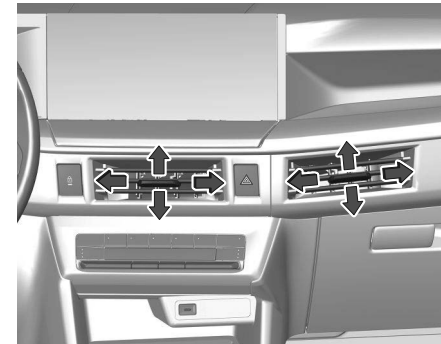

Direct the flow of air by tilting and swivelling the slats.

To close the vent, swivel the slats inwards.

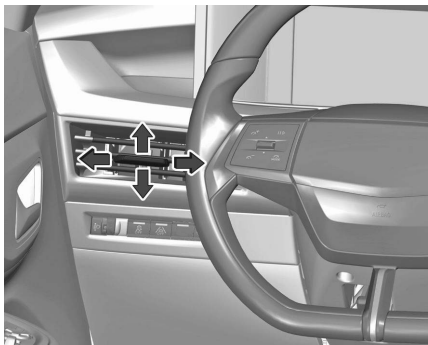

Direct the flow of air by tilting and swivelling the slats. To close the vent, swivel the slats outwards.

Fixed Air Vents

Additional air vents are located beneath the windscreen and door windows in the foot wells.

Maintenance

Air Intake

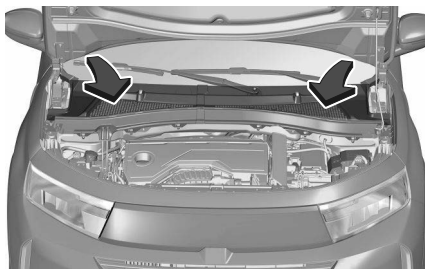

The air intake in front of the windscreen in the engine compartment must be kept clear to allow air intake. Remove any leaves, dirt or snow.

Air Conditioning Regular Operation

In order to ensure continuously efficient performance, cooling must be operated for a few minutes once a month, irrespective of the weather and time of year. Operation with cooling is not possible when the outside temperature is too low.

Service

For optimal cooling performance, it is recommended to annually check the climate control system, starting three years after initial vehicle registration, including:

- functionality and pressure test
- heating functionality
- leakage check
- check of drive belts
- cleaning of condenser and evaporator drainage
- performance check

Driving And Operating

| | |
|------------------------------------|-----|
| Driving Hints..... | 89 |
| Control Of The Vehicle..... | 89 |
| Steering..... | 89 |
| Starting And Operating..... | 89 |
| New Vehicle Running-In..... | 89 |
| Ignition Switch Positions..... | 90 |
| Starting The Engine..... | 90 |
| Overrun Cut-Off..... | 91 |
| Stop-Start System..... | 91 |
| Leaving The Vehicle..... | 93 |
| Parking..... | 93 |
| Engine Exhaust..... | 93 |
| Exhaust Filter..... | 93 |
| Catalytic Converter..... | 94 |
| Electric Drive Unit..... | 94 |
| Automatic Transmission Hybrid | |
| 48 V..... | 95 |
| Electric Engine (Hybrid 48 V)..... | 97 |
| e-Auto mode..... | 98 |
| Brakes..... | 99 |
| Antilock Brake System..... | 99 |
| Parking Brake..... | 100 |
| Brake Assist..... | 101 |
| Hill Start Assist..... | 101 |
| Charging..... | 102 |
| General Information..... | 102 |
| High Voltage Battery..... | 102 |
| Charging Types..... | 103 |
| Charging Cable..... | 104 |
| Charging..... | 106 |
| Programmable Charging..... | 108 |

| | |
|-----------------------------|-----|
| Charging Status..... | 109 |
| Fuel..... | 109 |
| Refuelling..... | 110 |
| Fuel Consumption And CO2 | |
| Emissions..... | 111 |
| Trailer Hitch..... | 111 |
| General Information..... | 111 |
| Driving Characteristics And | |
| Towing Tips..... | 112 |
| Trailer Towing..... | 112 |
| Towing Equipment..... | 112 |

Driving Hints

Control Of The Vehicle

Never coast with engine not running

Many systems will not function in this situation (e.g. brake servo unit, power steering). Driving in this manner is a danger to yourself and others. All systems function during an Autostop. Stop-start system⇒ page 91

Pedals

To ensure the pedal travel is uninhibited, there must be no mats in the area of the pedals.

Use only floor mats, which fit properly and are fixed by the retainers on the driver side.

Steering

If power steering assist is lost because the engine stops or due to a system malfunction, the vehicle can be steered but may require increased effort.

Starting And Operating

New Vehicle Running-In

Do not brake unnecessarily hard for the first few journeys.

During the first drive, smoke may occur because of wax and engine oil evaporating off the exhaust system. Park the vehicle in the open for a while after the first drive and avoid inhaling the fumes.

During the running-in period, fuel and engine oil consumption may be higher. Additionally, the cleaning process of the exhaust filter may take place more often. Exhaust filter ⇒ page 93

Ignition Switch Positions

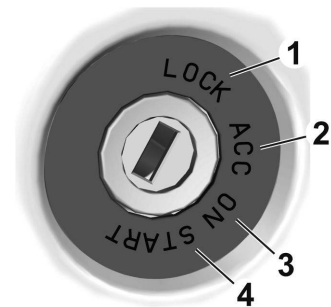

- 1 inserting and removing the key, steering wheel locked
- 2 ignition off: some functions remain active until key is removed or driver's door is opened, provided the ignition

was on previously, steering wheel unlocked

- 3 ignition on power mode: ignition is on, engine running, control indicators illuminate and most electric functions are operable, steering wheel unlocked
- 4 engine start: release key after engine has been started

Steering wheel lock

Remove the key from the ignition switch and turn the steering wheel until it engages.

Warning

Never remove the key from ignition switch during driving as this will cause steering wheel lock.

Starting The Engine

Vehicles with ignition switch

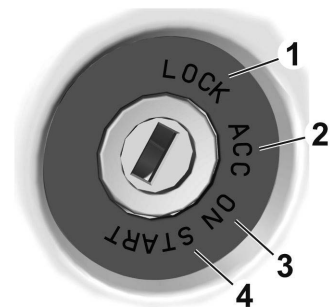

Turn key to position 3 to release the steering wheel lock.

Automatic transmission: operate brake pedal.

Do not operate accelerator pedal.

Turn key briefly to position 4 and release after engine has been started.

Stop-start System ⇒ page 91

Automatic transmission: during an Autostop, the engine can be started by releasing the brake pedal.

Stop-start System ⇒ page 91

Starting the vehicle at low temperatures

Starting the engine without additional heaters is possible down to -30 °C for petrol engines.

Required is an engine oil with the correct viscosity, the correct fuel, performed

services and a sufficiently charged vehicle battery.

With temperatures below $-30\text{ }^{\circ}\text{C}$ the automatic transmission requires a warming phase of approx. five minutes. The selector lever must be in position **P**.

Turbo engine warm-up

Upon start-up, engine available torque may be limited for a short time, especially when the engine temperature is cold. The limitation is to allow the lubrication system to fully protect the engine.

Overrun Cut-Off

The fuel supply is automatically cut off during overrun, i.e. when the vehicle is driven with a gear engaged but accelerator pedal is released. Depending on driving conditions, the overrun cut-off may be deactivated.

Stop-Start System

The stop-start system helps to save fuel and to reduce the exhaust emissions. When conditions allow, it switches off the engine as soon as the vehicle is at a low speed or at a standstill, e.g. at a traffic light or in a traffic jam.

Activation

By default, the system is activated when the ignition is switched on.



The system is ready to operate when the LED in the button is not illuminated.

To activate the system when the system is deactivated, press **A**.

If the stop-start system is temporarily not available and the button is pressed, the LED in the button flashes.

Deactivation

Deactivate the stop-start system manually by pressing **A**.

The deactivation is indicated when the LED in the button illuminates.

Autostop

Vehicles with automatic transmission

If the vehicle is at a standstill with depressed brake pedal, Autostop is activated automatically.

The engine will be switched off while the ignition stays on. The stop-start system will be disabled on inclines of 12% or more.

Indication

An Autostop is indicated by control indicator



During an Autostop, the heating and brake performance will be maintained.

Conditions for an Autostop

The stop-start system checks if each of the following conditions is fulfilled.

- The stop-start system is not manually deactivated.
- The driver's door is closed or the driver's seat belt is fastened.
- The vehicle battery is sufficiently charged and in good condition.
- The engine is warmed up.
- The engine coolant temperature is not too high.

- The engine exhaust temperature is not too high, e.g. after driving with high engine load.
- The ambient temperature is not too low or too high.
- The climate control system allows an Autostop.
- The brake vacuum is sufficient.
- The self-cleaning function of the exhaust filter is not active.
- The vehicle was driven at least at walking speed since the last Autostop.

Autostop will be inhibited if these conditions are not met. In addition, Autostop may be inhibited:

- by certain settings of the climate control system ⇒ page 83
- immediately after higher speed driving
- in the case of new vehicle running-in ⇒ page 89
- by active demisting
- in the case of steep ascending or descending slopes
- if the vehicle has not exceeded 10 km/h since the last engine start

In these cases, the icon on the cluster flashes a few seconds and then goes off.

Note

The Autostop may be inhibited for several hours after a battery replacement or reconnection.

Vehicle battery discharge protection

To ensure reliable engine restarts, several vehicle battery discharge protection features are implemented as part of the stop-start system.

Power saving measures

During an Autostop, several electric features such as auxiliary electric heater or rear window heating are disabled or switched to a power saving mode. The fan speed of the climate control system is reduced to save power.

Restart of the engine by the driver

After the engine has been restarted, an Autostop is not available until the vehicle has reached a speed of 8 km/h.

Vehicles with automatic transmission

The engine is restarted in the following cases:

- brake pedal released while the selector lever in position **D** or **M**
- brake pedal released or selector lever in position **N** when selector lever is moved to position **D** or **M**

- selector lever moved to position **R**

Restart of the engine by the stopstart system

If one of the following conditions occurs during an Autostop, the engine will be restarted automatically by the stop-start system:

- stop-start system manually deactivated
- driver's seat belt unfastened and driver's door opened
- engine temperature too low
- charging level of vehicle battery below a defined level
- brake vacuum not sufficient
- vehicle is driven or rolls at least at walking speed
- climate control system requests engine start
- air conditioning manually switched on

If an electric accessory, e.g. a portable CD player, is connected to the power outlet, a brief power drop during the restart might be noticeable.

Leaving The Vehicle

Warning

Only leave the vehicle with propulsion system off, parking brake applied and depending on transmission first gear engaged or **P** selected.

Parking

Warning

- Do not park the vehicle on an easily ignitable surface. The high temperature of the exhaust system could ignite the surface.
- Apply the parking brake.
- If the vehicle is on a level surface or uphill slope, engage first gear or set the selector lever to position **P**. On an uphill slope, turn the front wheels away from the kerb.
If the vehicle is on a downhill slope, engage reverse gear or set the selector lever to position **P**. Turn the front wheels towards the kerb.
- Close the windows.
- Switch off the engine.

- Remove the ignition key from the ignition switch or switch off ignition on vehicles with power button. Depending on version, turn the steering wheel until the steering wheel lock is felt to engage.

- Lock the vehicle.
- Activate the anti-theft alarm system.
- The engine cooling fans may run after the engine has been switched off ⇒ page 140

Caution

After running at high engine speeds or with high engine loads, operate the engine briefly at a low load or run in neutral for approx. 30 seconds before switching off, in order to protect the turbocharger.

Note

In the event of an accident with airbag deployment, the engine is switched off automatically if the vehicle comes to a standstill within a certain time. In countries with extremely low temperatures it may be necessary to park the vehicle without applied parking brake. Make sure to park the vehicle on a level surface.

Parking brake ⇒ page 100

Engine Exhaust

Warning

Engine exhaust gases contain poisonous carbon monoxide, which is colourless and odourless and could be fatal if inhaled. If exhaust gases enter the interior of the vehicle, open the windows. Have the cause of the fault rectified by a workshop. Avoid driving with an open load compartment, otherwise exhaust gases could enter the vehicle.

Exhaust Filter

Automatic cleaning process

The exhaust filter system filters soot particles out of the exhaust gases. The start of saturation of the exhaust filter is indicated by the temporary

illumination of  accompanied by a message on the cluster.

As soon as the traffic conditions permit, regenerate the filter by driving at a vehicle speed of at least 60 km/h until the control indicator extinguishes.

Note

On a new vehicle, the first exhaust filter regeneration operations may be accompanied by a burning smell, which is normal. Following prolonged operation of the vehicle at very low speed or at idle, water vapour can be emitted at the exhaust on acceleration. This does not affect the behaviour of the vehicle or the environment.

Cleaning process not possible

If  stays on, accompanied by an audible signal and a message, this indicates that the exhaust filter additive level is too low.

The reservoir must be topped-up without delay. Seek the assistance of a workshop.

Catalytic Converter

The catalytic converter reduces the amount of harmful substances in the exhaust gases.

 **Warning**

Fuel grades other than those listed on pages ⇒ 223, ⇒ 282 could damage the catalytic converter or electronic components.

Unburnt fuel will overheat and damage the catalytic converter.

Therefore avoid excessive use of the starter, running the fuel tank dry and starting the engine by pushing or towing.

In the event of misfiring, uneven engine running, a reduction in engine performance or other unusual problems, have the cause of the fault rectified by a workshop as soon as possible. In an emergency, driving can be continued for a short period, keeping vehicle speed and engine speed low.

Electric Drive Unit

The vehicle uses an electric drive unit with a 1-gear transmission.

Caution

If the vehicle seems to accelerate slowly or not respond when you try to go faster, do not continue your journey. The electric drive unit could be damaged. Consult a workshop as soon as possible.

Caution

Spinning the tires or holding the vehicle in one place on a hill using only the accelerator pedal may damage the

electric drive unit. If you are stuck, do not spin the tires. When stopping on a hill, use the brakes to hold the vehicle in place.

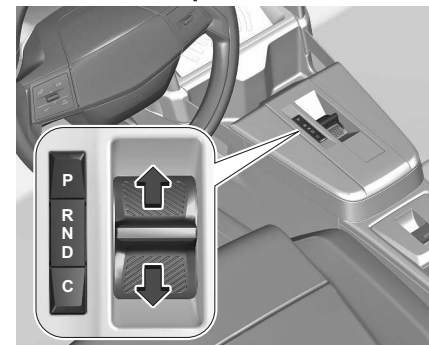
Selector lever operation

Move the selector or press the respective buttons.

- P** Park mode
- R** Reverse mode
- N** Neutral mode
- D** Automatic mode
- C** Comfort mode

After moving the selector it returns to the centre position. The engaged mode is indicated on the cluster.

Moving the selector beyond the resistance point skips neutral mode **N**. Never depress the accelerator pedal and brake pedal at the same time. When **D** or **R** is engaged, the vehicle slowly begins to creep when the brake is released.

Park mode P

To engage **P**, press button **P** when vehicle is stationary. In **P**, the front wheels of the vehicle are blocked. To disengage **P**, depress the brake pedal and select the desired mode. **P** is automatically engaged when

- the ignition is switched off
- the driver's door is opened while the vehicle's speed is below 5 km/h
- **N** has been selected for some time

If the vehicle is moving too fast **P** is not engaged.

Reverse mode R

To engage or disengage **R**, the vehicle must be at standstill and the brake pedal has to be depressed.

Caution

Engaging **R** while the vehicle is moving forward could damage the automatic

transmission. Only select **R** after the vehicle has been stopped.

Neutral mode N

In this mode, the propulsion system does not transfer torque to the wheels.

Automatic mode D with regenerative braking

This mode is for normal driving. When **D** is engaged, regenerative braking is enabled by default.

Comfort mode C

Press **C** to deactivate regenerative braking. The LED in the button illuminates. Press **C** again to enable regenerative braking. Regenerative braking ⇒ page 101

Automatic Transmission Hybrid 48 V

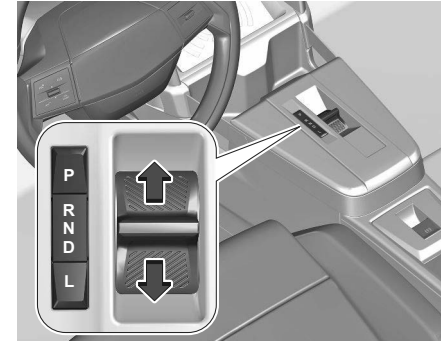

- P** : Park mode
- R** : Reverse mode
- N** : Neutral mode
- D** : Automatic mode
- L** : Low dynamic mode

After moving the selector it returns to the centre position. The engaged mode is indicated on the cluster.

Moving the selector beyond the resistance point skips neutral mode **N**. Never depress the accelerator pedal and brake pedal at the same time.

When **D** or **R** is engaged, the vehicle slowly begins to creep when the brake is released.

Park mode P

To engage **P**, press button **P** when vehicle is stationary. In **P**, the front wheels of the vehicle are blocked.

To disengage **P**, depress the brake pedal and select the desired mode. **P** is automatically engaged when

- the ignition is switched off
- the driver's door is opened while the vehicle's speed is below 5 km/h
- **N** has been selected for some time

Reverse mode R

To engage or disengage **R**, the vehicle must be at standstill and the brake pedal has to be depressed.

Caution

Engaging **R** while the vehicle is moving forward could damage the automatic transmission. Only select **R** after the vehicle has been stopped.

Neutral mode N

In this mode, the propulsion system does not transfer torque to the wheels.

Automatic mode D

This mode is for normal driving.
Hybrid 48 V ⇒ page 95

e-Auto mode ⇒ page 98

Low dynamic mode L

This mode provides more engine braking when going downhill.

Press **L** to engage low dynamic mode.

Free wheeling / car wash mode

In certain situations, e.g., in an automatic car wash etc., it is necessary that the wheels can move freely when the engine is switched off.

To enable free wheeling, the vehicle has to be stationary, the engine has to be running and the driver's door has to be closed.

ICE and BEV:

1. Depress the brake pedal and select **N**.
2. Release the brake pedal and switch off ignition.

A message is displayed on the cluster indicating that the wheels are unblocked for the next 15 minutes.

To revert to normal operation, depress and hold the brake pedal, switch on the engine and press **P**.

Hybrid 48 V:

No free wheeling with the engine switched off.

Gear shift indication ▲ or ▼

▲ or ▼ with a number beside it is indicated when gearshifting is recommended for fuel saving reasons.

Electronic driving programmes

Following a cold start, the operating temperature programme increases engine speed to quickly bring the catalytic converter to the required temperature.

Special programmes automatically adapt the shifting points when driving up inclines or down hills.

In snowy or icy conditions or on other slippery surfaces, the electronic transmission control enables the driver to select manually first, second or third gear for starting off.

Fault

In the event of a fault,  illuminates a message is displayed on the cluster.

Vehicle messages ⇒

Do not drive faster than 100 km/h.
Seek the assistance of a workshop.

Interruption of power supply

In the event of an interruption of power supply, it is not possible to select another mode when **P** is engaged.

Towing the vehicle ⇒ page 158

If the vehicle battery is discharged, start the vehicle using jump leads.

Jump starting ⇒ page 157

If the vehicle battery is not the cause of the fault, seek the assistance of a workshop.

Hybrid 48 V characteristics

The electric engine operates during start and acceleration. Driving propelled by electric engine only is possible at low speeds, e.g. during parking manoeuvres or stop and go traffic. If driving on motorways with a slope at a speed less than 150 km/h, the ICE is switched off automatically when possible and the vehicle is propelled by the electric engine for a short distance.

Electric Engine (Hybrid 48 V)

The electric engine included in the automatic gearbox, which is used for the first start, provides 12 V power supply via the DC/DC converter and provides electric assistance to the petrol engine. The electric engine has the following features:

- Provide an additional torque to the gearbox, optimising the performance of the petrol engine.

- Recover the kinetic energy of the deceleration phases, converting it into electrical energy, which can be used for traction or for the power supply of electrical accessories installed on the vehicle.
- Recharge the 48 V traction battery when the state of charge is too low.
- Provide all-electric driving only.

These features are achieved through the following functions set of automatic operating mode:

- e-Boost
- e-Creeping
- e-Launch
- e-Queueing
- e-Parking

A manual operating mode is also available to activate/deactivate the restart of the petrol engine while driving: the e-Auto mode.

Caution

When mode **P** or **N** is selected on the automatic gearbox, the noise level in the engine compartment may increase due to the start of the charging phase of

the traction battery: this is normal and does not represent a malfunction.

Operation

Only appropriate mode change instructions are validated.

With the engine running, if it is necessary to depress the brake pedal to change modes, an alert message will be displayed on the instrument panel.

Warning

With the engine running and the brakes released, if **R**, **D** or **L** is selected, the vehicle moves off, even without pressing the accelerator pedal. Never depress the accelerator and brake pedals at the same time - risk of damage to the gearbox!

Caution

If you open the driver's door while mode **N** is engaged, an audible signal will sound and mode **P** will be engaged. The audible signal stops when the driver's door is closed.

Warning

At speeds below 5 km/h opening the driver's door will engage mode P - risk of sudden braking!

Warning

In the event of battery failure, it is essential to place the chock(s) supplied with the tool kit against one of the wheels to immobilise the vehicle.

Special aspects of automatic mode

These functions respond to common driving situations where the electric engine is available to provide additional power or zero-emission driving.

Caution

These functions are only available if the traction battery is sufficiently charged. These five functions cannot be deactivated.

e-Launch

With the petrol engine off, this function allows the vehicle to run in electric mode without affecting performance.

By depressing the accelerator pedal, the vehicle starts to drive as soon as the

mode **D** or **R** of the automatic gearbox is selected.

e-Creeping

With the petrol engine off, by releasing the brake pedal, this function allows the vehicle to be moved forward or backward in electric mode without having to depress the accelerator pedal, as soon as the mode **D** or **R** of the automatic gearbox is selected.

e-Queueing

This function makes it possible to follow a queue of vehicles with several stops followed by restarts of the vehicle, using the e-Creeping, e-Launch and electric driving modes.

e-Parking

This function allows parking manoeuvres to be carried out at reduced speed with the help of the electric engine when the mode **D** or **R** of the automatic gearbox is selected.

e-Boost

This function allows simultaneous operation of the petrol engine and the electric engine, combined with the automatic gearbox.

By fully depressing the accelerator pedal ("kick-down" function), when the traction

battery is fully charged, it is possible to exceed the torque of the petrol engine alone, thanks to the additional torque provided by the electric engine.

Caution

Repeated use of the brake pedal causes the restart of petrol engine to provide braking assistance.

Special aspects of manual mode

The gearbox only changes from one gear to another if the vehicle speed and engine speed conditions permit.

The petrol engine can also be switched off in manual mode when stopped in traffic or when the accelerator pedal is released.

The all-electric potential of the driving mode used (**Normal** or **Eco**) is also retained.

e-Auto mode

The petrol engine stops when low power or torque is required and in stabilised conditions. The petrol engine is restarted by the belt starter.

The e-Auto mode can switch off the petrol engine in the following cases:

- When the operating strategies permit.

- Vehicle speed up to 145 km/h.
- When the driver releases the accelerator pedal in stabilised conditions or in deceleration.
- During the stop phases.

Restarting is only achieved by the belt starter until the torque demand is available, if the traction battery is sufficiently charged. When the torque demand is insufficient, the petrol engine restarts.

Caution

Using the steering wheel paddles also causes the restarting of petrol engine.

The e-Auto mode cannot switch off the petrol engine in the following cases:

- The state of charge is less than 30% of the traction battery energy.
- There is a need for vacuum brake assist depending on the altitude.
- The Sport mode is selected.
- Maintaining thermal comfort in the passenger compartment (heating, air conditioning, demisting/defrosting).

Deactivation/Reactivation

By default, the function is activated when the ignition is switched on.

The "**e-Auto OFF**" control on the dashboard activates/deactivates the e-Auto mode

- Press the dashboard button.

The display of a message on the instrument panel confirms the change of state.

When the function is deactivated, the e-auto indicator lights up in the instrument panel.

Caution

If high traction is required, the driver can deactivate the e-Auto mode using the dashboard button.

Brakes

Antilock Brake System

Antilock brake system (ABS) prevents the wheels from locking. ABS starts to regulate brake pressure as soon as a wheel shows a tendency to lock. The vehicle remains steerable, even during hard braking.

ABS control is made apparent through a pulse in the brake pedal and the noise of the regulation process.

For optimum braking, keep the brake pedal fully depressed throughout the

braking process, despite the fact that the pedal is pulsating. Do not reduce the pressure on the pedal.

When braking in an emergency, the hazard warning flashers are switched on automatically depending on the force of deceleration. They are switched off automatically the first time you accelerate.

After starting off, the system performs a self-test which may be audible.



Control indicator ⇨ page 49

Fault

⚠ Warning

If there is a fault in the ABS, the wheels may be liable to lock due to braking that is heavier than normal. The advantages of ABS are no longer available. During hard braking, the vehicle can no longer be steered and may swerve.

Have the cause of the fault remedied by a workshop.

Parking Brake



Warning

Before leaving the vehicle, check parking brake status. Control that indicator illuminates constantly when electric parking brake is applied.



Applying when vehicle is stationary

Warning

Pull  for a minimum of one second until  illuminates constantly and the electric parking brake is applied. The electric parking brake operates automatically with adequate force.

Before leaving the vehicle, check the electric parking brake status. ⇨

The electric parking brake can always be activated, even if the ignition is off. Do not operate the electric parking brake system too often without engine running as this will discharge the vehicle battery.

Releasing

Switch on the ignition. Keep the foot brake pedal depressed and then push .

Drive away function

Vehicles with automatic transmission: Engaging **R**, **D**, **C** or **L** and then depressing the accelerator pedal releases the electric parking brake automatically. This is only possible if the automatic operation of the electric parking brake is activated. It is not

possible when  is pulled at the same time.

Braking when vehicle is moving

When the vehicle is moving and  is kept pulled, the electric parking brake system will decelerate the vehicle. As

soon as  is released, braking will be stopped.

The antilock brake system and the Electronic Stability Control stabilize the

vehicle while  is kept pulled. If an error of the electric parking brake occurs, a warning message is displayed on the cluster.

If the antilock brake system and the Electronic Stability Control fail, one or

both of these control indicators  illuminate on the cluster. In this case, stability during deceleration of the vehicle can only be maintained with repeated short pulls of the switch until the vehicle is immobilized.

Automatic operation

Automatic operation includes automatic application and automatic release of the electric parking brake.

The electric parking brake can also be applied or released manually by using .

Automatic application

- The electric parking brake is automatically applied when the vehicle is stationary and the ignition is switched off.

- (P) illuminates on the cluster and a display message pops up to confirm the application.

Automatic release

The automatic release of the electric parking brake is inhibited as long as the driver's door is open.

Parking brake releases automatically on driving off.

- (ABS) extinguishes on the cluster and a display message pops up to confirm the release.

Deactivation of automatic operation

In certain situations, e.g. in extreme cold weather conditions or when towing, it may be necessary to deactivate the automatic operation of the electric parking brake.

1. Start the engine.
2. If the parking brake is released, pull (P) to apply the parking brake.
3. Take your foot off the brake pedal.
4. Press (P) for at least ten seconds and maximum 15 seconds.
5. Release (P).
6. Depress and hold the brake pedal.
7. Pull (P) for two seconds.

Fault

Failure mode of electric parking brake is

indicated by the control indicator (P)! and by a message displayed on the cluster. Control indicator of parking brake flashes: electric parking brake is not fully applied or released. When continuously flashing, release electric parking brake and retry applying.

Brake Assist

If the brake pedal is depressed quickly and forcefully, maximum brake force is automatically applied.

Operation of brake assist might become apparent by a pulse in the brake pedal and a greater resistance when depressing the brake pedal. Maintain steady pressure on the brake pedal as long as full braking is required. Maximum brake force is automatically reduced when brake pedal is released.

Hill Start Assist

The system helps prevent unintended movement when driving away on inclines.

When releasing the brake pedal after stopping on an incline, brakes remain on for further two seconds. The brakes release automatically as soon as the vehicle begins to accelerate.

Leaving the vehicle ⇨ page 93

Regenerative braking

Warning

In the case of extreme temperatures or if the high voltage battery is almost fully charged, the brake force of the engine braking may be temporarily reduced. If the braking force is not sufficient, the driver has to be prepared to use the brake pedal.

Warning

Depending on the engine braking force the brake lights are illuminated.

BEV: Regenerative braking generates electric energy resulting from engine braking to charge the high voltage battery.

Electric drive unit ⇨ page 94

Hybrid 48 V vehicle: Regenerative braking generates electric energy resulting from engine braking to charge the 48 V battery.

Automatic transmission Hybrid 48 V ⇨ page 95

Charging

General Information

Warning

Persons with a pacemaker should consult a doctor for possible precautions.

Charging the vehicle's high voltage battery depends upon several factors:

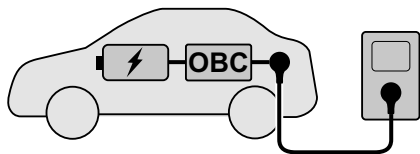

- high voltage battery of the vehicle
- internal onboard charger (OBC)
- charging cable
- external charging device

The charging cable connects the vehicle with an external charging device providing electric power. This may be a domestic electrical outlet, a Green'UP socket, a wall box or a public charging station.

The high voltage battery is charged with direct current (DC) only. When charging the vehicle with alternating current (AC), AC has to be converted into DC. This is done by the vehicle's onboard charger. The onboard charger is available with 7.4 kW (single-phase) and 11 kW (3-phase). If the vehicle is charged at a public DC charging station, no DC conversion is required. The high voltage battery can be directly charged with DC provided by the DC charging station.

The speed of charging the vehicle's high voltage battery depends upon the weakest element of the charging chain. To achieve the maximum charging speed, charging cable and charging device have to be attuned to each other.

Note

Make sure that the charging cable used fits to the vehicle's onboard charger.

Charging types ⇒ page 103

Charging cable ⇒ page 104

Electric power consumption and range

The electric power consumption (combined) is within a range of 18.5 kWh / 100 km.

The range is up to 400 km.

For the values specific to your vehicle, refer to the Certificate of Conformity provided with your vehicle or other national registration documents.

The determination of electric power consumption is regulated by directive R (EC) No. 715/2007 and No. 2017/1151 (in the latest applicable version).

High Voltage Battery

Warning

Damage to the high voltage battery or high voltage system can create a risk of electric shock, overheating, or fire.

If the vehicle has been damaged or affected by a moderate to severe crash, it must be inspected as soon as possible by qualified personnel.

Until the technical inspection has been carried out, the vehicle must be stored outside at a minimum distance of 5 metres from any structure or other flammable objects.

If the vehicle has been damaged or affected by flood or fire, it must not be moved at all and has to be inspected by qualified personnel as soon as possible.

To preserve the range and the durability of the high voltage battery, the following is recommended:

- Whenever possible do not charge the high voltage battery more than 80%.
- Do not completely discharge the high voltage battery.
- Do not store the vehicle for a long period of non-use (more than twelve hours) when the high voltage battery has a low or high charge level. Prefer a charge level between 20 and 40%.
- Limit the use of fast charging.
- Do not expose the vehicle to temperatures below -30 °C and above 60 °C for more than 24 hours.
- Avoid charging the vehicle at low temperatures (except if the vehicle ran more than 20 minutes) or above 30 °C.
- Do not use the high voltage battery as a generator of energy.
- Do not use a generator to recharge the high voltage battery.

Vehicle storage ⇒ page 138

Leakage

Damage to the high voltage battery could result in the leakage of toxic gases or fluids either immediately or later. The following is recommended:

- Always inform the fire and emergency services in the event of an incident, that the vehicle is equipped with a high voltage battery.
- Never touch the liquids leaking from the high voltage battery.
- Do not inhale the gases emitted by the high voltage battery which are toxic.
- Move away from the vehicle in the event of incident or accident, the gases emitted being flammable and could cause a fire.
- Too low a coolant level must be topped up and the cause of the coolant loss remedied by a workshop.

Charging Types

There are different types of charging the vehicle's high voltage battery.

Charging at wallboxes



A wallbox is a charging unit for private households. It provides a charging cable which has to be connected to the vehicle's charging port. Some wallboxes do not provide a charging cable. In this case, a separate charging cable is required which has to be connected to both the wallbox and the charging port of the vehicle.

Charging time may take approx. five hours with a charging power of 11kW or seven and half hours with a charging power of 7.4kW.

Charging at charging stations

Charging stations may provide alternating current (AC) or direct current (DC). Charging time may vary depending

on the charging station, DC charging stations provide the fastest charging. To charge the vehicle's battery, the charging cable of the charging station has to be connected to the charging port of the vehicle.



- AC charging station: Charging time may take approx. five hours with a charging power of 11kW or seven and half hours with a charging power of 7.4kW.



- DC charging station: Up to approx. 80% of battery capacity may be charged in approx. 30 minutes at a charging power of 100kW.

Charging at domestic electrical outlets



The vehicle's high voltage battery can be charged at a domestic electrical outlet. Connect the charging cable to the vehicle's charging port and to the domestic electrical outlet. Charging time may take approx. 30 hours with a charging power of 1.8kW.

Charging Cable

Depending on the charging type, different charging cables are used.

Warning

Improper use of portable charging cables may cause a fire, electrical shock, or burns, and may result in damage to property, serious injury, or death.

- Do not use extension cables, multi-outlet power strips, splitters, grounding adaptors, surge protectors, or similar devices.

- Do not use an electrical socket that is worn or damaged, or one that will not hold the plug firmly in place.
- Do not immerse the charging cable into any liquid.
- Do not use an electrical socket that is not properly grounded.
- Do not use an electrical socket that is on a circuit with other electrical loads.

Warning

Read all the safety warnings and instructions before using this product. Failure to follow the warnings and the instructions may result in electric shock, fire, and / or serious injury. Never leave children unattended near the vehicle while the vehicle is charging and never allow children to play with the charging cable. If the plug provided does not fit the electrical outlet, do not modify the plug. Arrange for a qualified electrician to inspect the electrical outlet. Do not put fingers into the electric vehicle connector.

Danger

There is a risk of electric shock that may cause personal injury or death. Do not use the charging cable if any part of the charging cable is damaged. Do not open or remove the charging cable cover.

Service by qualified personnel only. Connect the charging cable to a properly grounded outlet with cables that are not damaged.

Basic domestic cable (mode 2) / enhanced domestic cable (mode 2)

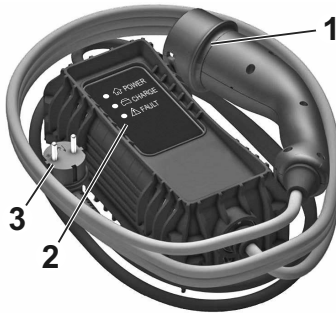

1. Vehicle plug
2. Status indicators
3. Wall plug

Basic domestic cables (mode 2) are used for charging at domestic electrical outlets. A basic domestic cable (mode 2) consists of a vehicle plug, a control box and a plug for the domestic electrical outlet. The control box has an integrated charge controller and several LEDs indicating the charging status.

Enhanced domestic cables (mode 2) are similar to basic domestic cables (mode 2). However, the charging performance of enhanced domestic cables (mode 2 charging) is better than the charging performance of basic domestic cables (mode 2).

Enhanced domestic cables (mode 2) are used at Green'Up sockets which have to be installed by a certified electrician at the customer's site.

Charging cable status indicators

After plugging in the charging cable, it will perform a quick self test and all status indicators illuminate for a moment. For the functions of the status indicators, refer to the manual of the charging cable manufacturer.

Important information about portable electric vehicle charging

- Charging an electric vehicle can stress a building's electrical system more than a typical household appliance.

- Before you plug in to any electrical outlet, have a qualified electrician inspect and verify the electrical system (electrical outlet, wiring, junctions and protection devices) for heavyduty service at a 10 A continuous load.
- Electrical outlets may wear out with normal usage or be damaged over time, making them unsuitable for electric vehicle charging.
- Check the electrical outlet / plug while charging and discontinue use if the electrical outlet / plug is hot, then have the electrical outlet serviced by a qualified electrician.
- When outdoors, plug into an electrical outlet that is weatherproof while in use.
- Mount the charging cable to reduce strain on the electrical outlet / plug.

Mode 3 charging cable

1. Vehicle plug
2. Plug for wall box / AC charging station

Mode 3 charging cables are used for charging at wall boxes and AC charging stations. A mode 3 charging cable provides a vehicle plug and a plug for the wall box / AC charging station. Wall boxes / AC charging stations may provide an integrated mode 3 charging cable. For more information on the mode 3 charging cable, refer to the manual of the charging cable manufacturer.

Mode 4 charging cable**Note**

Only use DC charging cables shorter than 30 metres.

Mode 4 charging cables are used for DC charging. Since mode 4 charging cables are integrated within DC charging stations, they only provide a vehicle plug.

Charging

| ⚠ Warning |
|---|
| <p>Persons with a pacemaker or similar devices should consult a doctor for possible precautions. If in doubt, during charging do not remain inside or near the vehicle, near the charging cable or the charging unit.</p> |

In order to ensure the compatibility of plug and outlet, different labels are used. The labels are located on the inside of the vehicle's charging port flap. Make sure to connect only a cable of the same type.

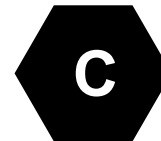

Type 2 plug or outlet used for AC charging

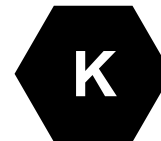

FF plug or outlet used for DC charging

⚠ Warning

Avoid any entry of fluids into the charging port of the vehicle, the vehicle plug of the charging cable and the domestic electrical outlet.

When charging at a public AC charging station / public DC charging station, follow the instructions for the use of the respective charging station. Public AC charging stations may not provide an integrated charging cable. In this case, a portable mode 3 charging cable is required.

⚠ Warning

When charging at a domestic electrical outlet, only use an outlet which is properly grounded and protected by a 30 mA differential switch.

Only use a domestic electrical outlet protected by a circuit breaker adapted to the amperage of the electrical circuit. Have a qualified electrician check the electrical installation to be used. The installation has to be in compliance with national standards and compatible with the vehicle.

When using a dedicated domestic electrical outlet, have it installed by a qualified electrician.

Make sure that the electrical outlet, the plug and the cable do not support the weight of the control box.

1. Shift into **P** and switch off the vehicle.

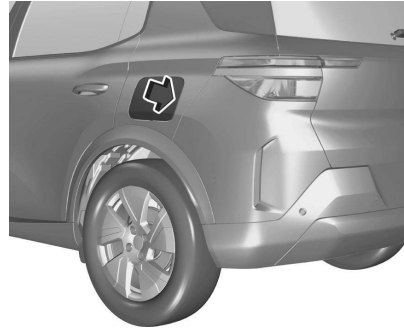

2. Push the charging port flap to release it.
3. If necessary, take the charging cable out of the load compartment.
4. If necessary, plug in the plug of the charging cable into the corresponding port of the external power source. ⇨ page 104

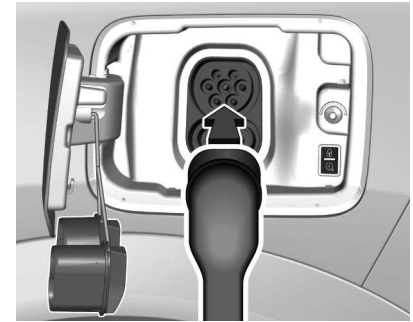

5. Plug in the vehicle plug of the mode 3 charging cable into the charging port of the vehicle.

Charging status ⇒ page 109

The start of charging is indicated by the green flashing of the status indicator at the charging port and at the control box of the charging cable, if available.

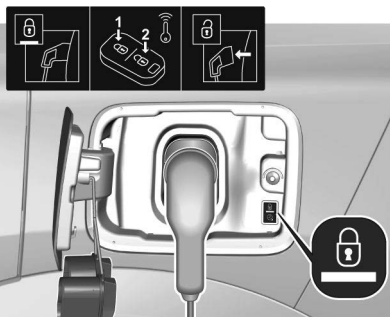



Once charging, the vehicle plug will be locked to the charging port and cannot be disconnected while charging is active.  illuminates. Charging types ⇒ page 103

Cancelling the charging process

Note

At public charging stations, the cancelling and subsequent resuming of the charging process may cause additional costs.

Once the charging process has started, only the driver's door can be unlocked without cancelling the charging process. Therefore, activate the driver's door only function in the vehicle personalisation. Press  on the remote control to cancel the charging process at any time. Press  twice to cancel the charging process at any time if the function driver's door only is activated in the vehicle personalisation. Central locking system ⇒ page 6 Vehicle personalisation ⇒ page 59

Stop charging

The high voltage battery is fully charged if the status indicator on the charging port permanently illuminates green.

1. Unlock the vehicle before removing the vehicle plug from the charging port.
If the vehicle is already unlocked, lock the vehicle and unlock it again.

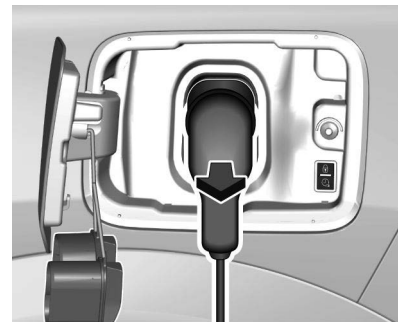

2. Disconnect the vehicle plug of the charging cable from the charging port within 30 seconds after unlocking.
3. Close the charging port flap by pressing firmly in the centre to latch properly.
4. Disconnect the charging cable from the external power source.
5. If necessary, store the charging cable in the load compartment.

While the charging cable is plugged into the vehicle, the vehicle cannot be driven.



Programmable Charging

By default, charging starts as soon as the charging cable is connected to the charging port of the vehicle. It is also possible to schedule charging using the Info Display.

Programmable charging is only possible when charging at a domestic electrical outlet / Green'Up socket or a wall box. Programmable charging is also available via the MyOpel App.

Note

On vehicles without integrated navigation system, programmable charging can only be used via the MyOpel App.

1. Press .
2. Select Charge.
Driving and operating ⇒ page 89
3. Press .
4. Define the number of hours and minutes after which the loading process starts.
5. Press **OK**.
6. Plug in the vehicle.

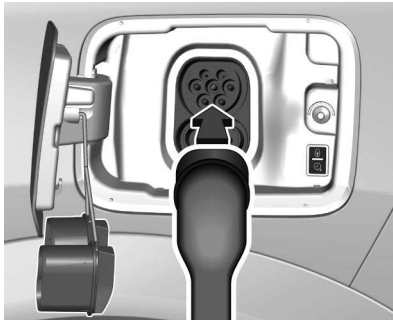

7. Within one minute, press  on the bottom right to activate programmable charging.
8. Depending on version, lock the vehicle.

The status indicator illuminates blue indicating that programmable charging is active.

Charging ⇒ page 102

Charging status ⇒ page 109

Charging Status

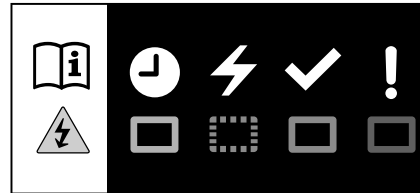

If the vehicle is plugged in and the ignition is switched off, the charging status indicator indicates the following:

- Illuminates white or pink: welcome lighting when charging port flap is opened
- Illuminates green: charging complete

- Flashes green: charging initialisation or is in process
- Illuminates blue: programmable charging active
- Illuminates red: malfunction

A malfunction may be caused by the vehicle or the electrical installation at the customer's site.

Further charging status indicators are located on the control box of the basic domestic cable (mode 2) / enhanced domestic cable (mode 2).

Charging cable ⇒ page 104

Programmable charging ⇒ page 108

Fuel



Only use unleaded fuel that complies with European standard EN 228 or E DIN 51626-1 or equivalent.

The engine is capable of running with fuel that contains up to 10% ethanol (e.g. named E10).

Use fuel with the recommended octane rating. A lower octane rating can reduce engine power and torque and slightly increases fuel consumption.

Note

The only petrol additives authorized for are those that meet the B715001 standard.

Caution

Do not use fuel or fuel additives that contain metallic compounds such as manganese-based additives. This may cause engine damage.

Caution

Use of fuel with a lower octane rating than the lowest possible rating could lead to uncontrolled combustion and engine damage.

The engine specific requirements regarding octane rating are given in the engine data overview ⇒ page 167. A country-specific label at the fuel filler flap can supersede the requirement.

In certain countries, the use of a particular fuel, e.g. a specific octane rating, may be required to ensure proper engine operation.

Refuelling

⚠ Warning

Before refuelling, switch off ignition and any external heaters with combustion chambers.

Follow the operating and safety instructions of the filling station when refuelling.

⚠ Warning

Fuel is flammable and explosive. No smoking. No naked flames or sparks.

If you can smell fuel in your vehicle, have the cause of this remedied immediately by a workshop.

A label with symbols at the fuel filler flap is indicating the allowed fuel types. In Europe the pump nozzles of the filling stations are marked with these symbols. Refuel only the allowed fuel type.

Caution

In case of misfuelling, do not switch on ignition.

The fuel filler flap is located at the left rear side of the vehicle.

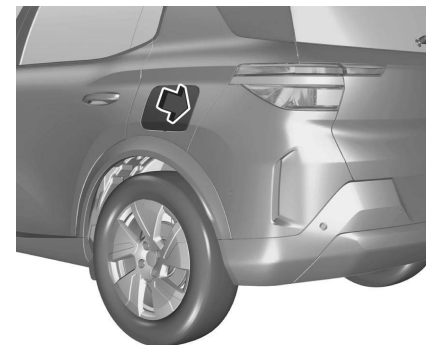

The fuel filler flap can only be opened if the vehicle is unlocked. Release the fuel filler flap by pushing the flap. To open, turn the cap slowly anticlockwise.

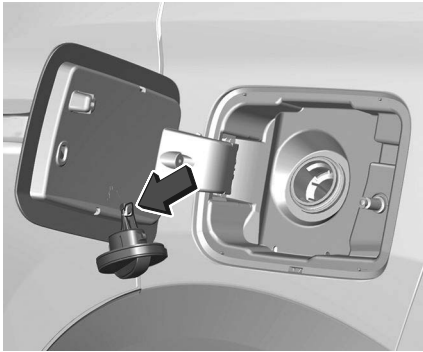

The fuel filler cap can be attached to the hook on the fuel filler flap.

Place the nozzle in straight position to the filler neck and press with slight force to insert.

To refuel, switch on the pump nozzle. After the automatic cut-off, the tank can be topped up by operating the pump nozzle a maximum of two more times.

Caution

Wipe off any overflowing fuel immediately.

To close, turn the fuel filler cap clockwise.

Close the flap and allow it to engage.

Fuel filler cap

Only use genuine fuel filler caps.

General information

For the values specific to your vehicle, refer to the Certificate of Conformity provided with your vehicle or other national registration documents.

The determination of fuel consumption is regulated by directive R (EC) No.715/2007 and No.2017/1151 (in the latest applicable version).

The specification of CO₂ emission is also a constituent of the directive.

The figures given must not be taken as a guarantee for the actual fuel consumption of a particular vehicle.

Furthermore, fuel consumption is dependent on personal driving style as well as road and traffic conditions.

All values are based on the EU base model with standard equipment.

The calculation of fuel consumption takes into account the vehicle's kerb weight, ascertained in accordance with the regulations. Optional equipment may result in slightly higher fuel consumption and CO₂ emission levels and a lower maximum speed.

Fuel Consumption And CO₂ Emissions

All values are combined values under WLTP condition.

ICE : The fuel consumption is within a range of 36 to 56 mpg.

The CO₂ emission is within a range of 148 to 111 g/km.

Propulsion types ⇨ page 3

Trailer Hitch

General Information

Caution

For new vehicles, only tow a trailer after having driven at least 997 kilometers.

Only use towing equipment that has been approved for your vehicle.

Entrust retrofitting of towing equipment to a workshop. It may be necessary to make changes that affect the cooling system, heat shields or other equipment. Fitting of towing equipment could cover the opening of the towing eye.

If this is the case, use the coupling ball bar for towing. Always keep the coupling ball bar in the vehicle to have it on hand if needed.

Driving Characteristics And Towing Tips

Before attaching a trailer, lubricate the coupling ball. However, do not do so if a stabilizer, which acts on the coupling ball, is being used to reduce snaking movements.

During trailer towing do not exceed a speed of 80 km/h. A maximum speed of 100 km/h is only appropriate if an oscillation damper is used and the permissible gross trailer weight does not exceed the vehicle's curb weight.

For trailers with low driving stability and caravan trailers, the use of an oscillation damper is strongly recommended.

If the trailer starts snaking, drive more slowly, do not attempt to correct the steering and brake sharply if necessary. When driving downhill, drive in the same gear as if driving uphill and drive at a similar speed.

Tire pressures ⇒ page 170

Trailer Towing

Trailer loads

The permissible trailer loads are vehicle and engine-dependent maximum values which must not be exceeded. The actual trailer load is the difference between the actual gross weight of the trailer and

the actual coupling socket load with the trailer coupled.

The permissible trailer loads are specified in the vehicle documents. In general, they are valid for inclines up to 12%.

The permissible trailer load applies up to the specified incline and at sea level. Since engine power decreases as altitude increases due to the air becoming thinner, therefore reducing climbing ability, the permissible gross train weight also decreases by 10% for every 1000 m of altitude. The gross train weight does not have to be reduced when driving on roads with slight inclines (less than 8%, e.g. motorways).

The permissible gross train weight must not be exceeded. This weight is specified on the identification plate ⇒ page 165

Vertical coupling load

Warning

If attaching accessories to the trailer hitch such as bicycle carriers, tow boxes etc., do comply with the maximum permissible vertical coupling load.

When using a bicycle carrier, do not transport more than four conventional bicycles or two electric bicycles. Make

sure to place the heaviest bicycle as close as possible to the vehicle.

The vertical coupling load is the load exerted by the trailer on the coupling ball. It can be varied by changing the weight distribution when loading the trailer.

The maximum permissible vertical coupling load 65 kg is specified on the towing equipment identification plate and in the vehicle documents.

Always aim for the maximum vertical coupling load, especially in the case of heavy trailers. The vertical coupling load should never fall below 25 kg.

Rear axle load

When the trailer is coupled and the towing vehicle fully loaded, the permissible rear axle load (see identification plate or vehicle documents) may be exceeded by 60 kg, the gross vehicle weight rating must not be exceeded. If the permissible rear axle load is exceeded, a maximum speed of 100 km/h applies.

Towing Equipment

Caution

When operating without a trailer, remove the coupling ball bar.

Stowage of coupling ball bar

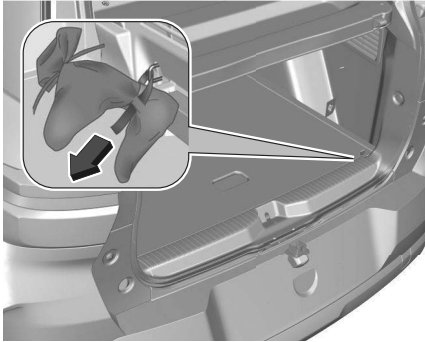

The bag with the coupling ball bar is stowed on the rear floor cover in the load compartment.

Place the strap through the rear right lashing eye, wrap around twice and tighten the strap to secure the bag.

Fitting the coupling ball bar

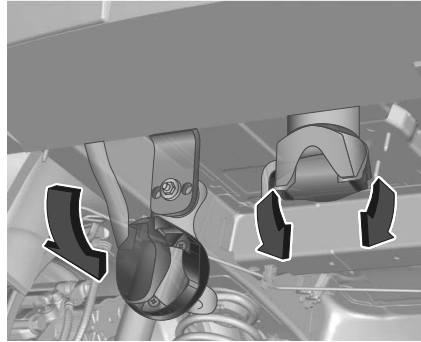

Swivel the connecting socket downwards. Remove the sealing plug from the opening for the coupling ball bar and stow it.

Checking the tensioning of the coupling ball bar

- The red marking on the rotary knob must point towards the green marking on the coupling ball bar.
- The gap between the rotary knob and the coupling ball bar must be approx. 6 mm.
- The key must be in unlock position.

Otherwise, the coupling ball bar must be tensioned before being inserted:

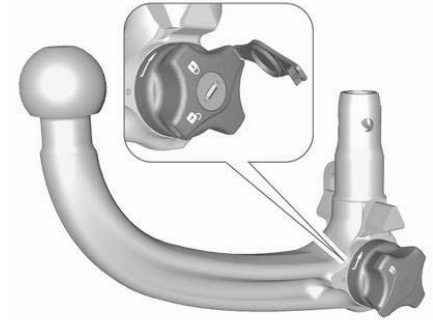

- Unlock the coupling ball bar by turning the key to unlock position.

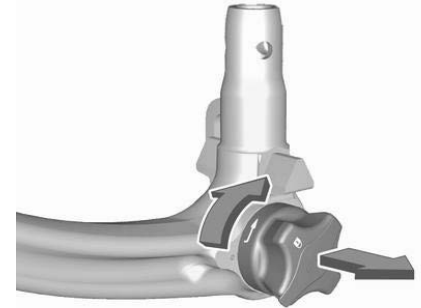

- Pull out the rotary knob and turn clockwise as far as it will go.

Inserting the coupling ball bar

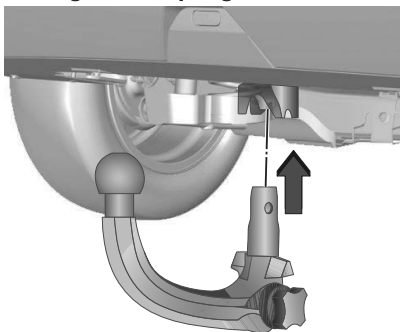

Insert the tensioned coupling ball bar in the opening and push firmly upwards until it audibly engages.

The rotary handle snaps back into its original position resting against the coupling ball bar without a gap.

Warning

Do not touch rotary handle during insertion.

Lock the coupling ball bar by turning the key to unlock position.

Eye for break-away stopping cable

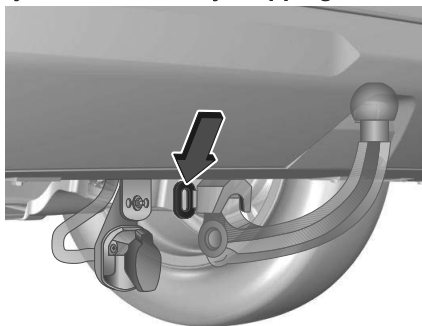

Attach the breakaway stopping cable to eye.

Checking the correct installation of the coupling ball bar

- The green marking on the rotary knob must point towards the green marking on the coupling ball bar.
- There must be no gap between the rotary handle and the coupling ball bar.
- The coupling ball bar must be firmly engaged in the opening.
- The coupling ball bar must be locked and the key removed.

Warning

Towing a trailer is permitted only when a coupling ball bar is fitted correctly. If the coupling ball bar does not engage correctly, seek the assistance of a workshop.

Dismounting the coupling ball bar

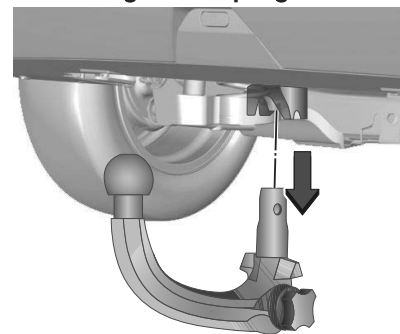

Open the protective flap and turn the key to unlock position to unlock the coupling ball bar.

Pull out the rotary handle and turn clockwise as far as it will go. Pull out the coupling ball bar downwards.

Insert the sealing plug in the opening. Swivel the connecting socket upwards. Stow the coupling ball bar in the bag and secure by fixing the strap through the

rear right lashing eye. Wrap around twice and tighten the strap to secure the bag.

Advanced Driving Assistance Systems

| | |
|---------------------------------------|-----|
| Driving Recommendations / | |
| Manoeuvring Aids..... | 116 |
| Active Emergency Braking (AEB)..... | 116 |
| Forward Collision Warning (FCW).... | 119 |
| Vehicle Stability Assistance | |
| System..... | 120 |
| Anti-Slip Regulator (ASR)..... | 120 |
| Electronic Stability Control (ESC)... | 121 |
| Selective Ride Control..... | 122 |
| Side Blind Spot Alert (SBSA)..... | 123 |
| Lane Departure Warning (LDW)..... | 124 |
| Lane Keeping Assist (LKA)..... | 125 |
| Parking Assist..... | 127 |
| Rear Vision Camera (RVC)..... | 129 |
| Driver Drowsiness Detection | |
| (DDD)..... | 130 |
| Cruise Control | 131 |
| Speed Limiter..... | 132 |
| Tire Deflation Detection System..... | 133 |
| Traffic Sign Assist (TSA)..... | 134 |

Driving Recommendations / Manoeuvring Aids

Warning

Driver assistance systems are developed to support the driver and not to replace the driver's attention. The driver accepts full responsibility when driving the vehicle. When using driver assistance systems, always take care regarding the current traffic situation.

Note

To comply with the European general safety regulations, some driver assistance systems can only be deactivated on the Info Display until the next time the ignition is reactivated. The system is automatically activated by default every time the engine is started.

Active Emergency Braking (AEB)

Active emergency braking can help to reduce the damage and injury from

crashes with vehicles, pedestrians and cyclists directly ahead, when the driver does not actively take action either by manual braking or by steering.

Before the active emergency braking applies, the driver may be warned by the forward collision warning.

The feature uses various inputs (e.g. camera sensor, brake pressure, vehicle speed) to calculate the probability of a frontal collision.

Warning

This system is not intended to replace the driver's responsibility for driving the vehicle and looking ahead. It warns the driver if the vehicle is at risk of a collision with the preceding vehicle, a pedestrian or a cyclist. Just before the imminent collision, it reduces the vehicle's speed to avoid a collision or to limit its severity.

The system may also react on animals. However, animals smaller than 0.5 m or objects on the road may not be detected.

After a sudden lane change, the system needs a certain time to detect the next preceding vehicle.

The driver must always be ready to take action and apply the brakes and steer to avoid collisions.

Activation/Deactivation

Depending on version, the system is automatically active by default every time the engine is started, even if it was deactivated during the last ignition cycle.

For further information ⇒ page 116

Active emergency braking can be deactivated in the vehicle personalization. Depending on version, deactivation is only possible at a standstill.

The system cannot be deactivated at a speed above 10 km/h.

 illuminates if deactivated, and a message is shown on the cluster.

Functionality

Depending on the vehicle configuration and the detected objects, there are several operational speed ranges.

Active emergency braking operates from 8 km/h to 85 km/h when a pedestrian or a cyclist has been detected.

Active emergency braking operates from 8 km/h to 135 km/h, when a moving or stationary vehicle has been detected.

The system includes:

- forward collision warning
- emergency brake assist
- automatic braking

Forward Collision Warning (FCW) ⇒ page 119

Automatic braking

Just before the imminent collision, this function automatically applies limited braking to reduce the impact speed of the collision or prohibit a crash.

If active emergency braking is applied,  flashes on the cluster.

If active emergency braking is finished,  flashes for a few seconds. During this time, active emergency braking cannot be applied if there is a risk of a further collision.

Below a speed of 50 km/h, automatic braking may slow down the vehicle to a complete stop. If the speed exceeds this limit, automatic braking may reduce the speed by a maximum of 50 km/h. However, the driver must apply the brake to come to a complete stop.

Automatic transmission: If the vehicle comes to a complete stop, automatic braking is maintained for a certain time. Keep the brake pedal depressed to prevent the vehicle from starting off again.

Cruise control will be deactivated when an automatic braking occurs. In some cases, the driver may wish to override the automatic braking provided by the

active emergency braking system. Firmly apply the accelerator pedal or firmly turn the steering wheel to override the automatic braking if the situation and the surroundings permit.

Warning

Do not rely on the system to brake the vehicle. Active emergency braking will not brake automatically outside of its operating speed range.

Emergency brake assist

If the driver brakes, but not sufficiently to avoid a collision, this system will supplement the braking. This assistance will only be provided if the driver presses the brake pedal.

Emergency brake assist will automatically disengage when the brake pedal is released.

Operation conditions

Active emergency braking only works when:

- the brake system is operational
- Electronic Stability Control and Anti-Slip Regulator (ASR) are activated
- the seat belt of the driver seat and depending on version of the front passenger seat is fastened

- constant speed on unwinding roads

Active emergency braking is automatically deactivated in the following cases:

- a spare wheel with smaller diameter is detected
- a fault with the brake pedal switch or with the left or right brake light is detected
- a fault in the active emergency braking system, in the electronic or in the brake system is detected
- a severe crash, e.g., with airbag deployment was detected

System limitations

The system performance may be degraded or not available in the following cases:

- front camera covered with snow, ice, slush, mud or dirt
- windscreen damaged or smeared, with blurred view or covered with foreign items, e.g. stickers
- front camera out of its regular position
- automatic braking not available, e.g. brake discs cooling going on
- brake pedal continuously used for a long time, e.g. on a long downhill road

- winding or hilly roads
- system initialization process after battery disconnection
- dazzling light, e.g. caused by the sun or artificial illumination is shining directly into the camera lens
- adverse environmental conditions, e.g. rain, fog, or snow
- vehicle ahead creating road spray

After an impact or when damages are visible have the vehicle checked by a workshop.

The system performance may be affected by:

- Electronic Stability Control and Anti-Slip Regulator (ASR) in progress
- vehicle battery voltage out of range
- wet road reflecting lights
- close vehicles ahead
- tractors, muddy vehicles or vehicles with a trailer
- banked roads
- poor lighting conditions
- sudden lighting changes
- vehicle modifications, e.g. tires
- vehicle overloaded

The driver must not overload neither the load compartment nor the roof of the vehicle.

If a sensor is covered, a message is displayed indicating that the camera sensors have to be cleaned.

If the system is temporarily affected and no driver action is required, no message is displayed.

Complete attention is always required while driving, and be ready to take action to avoid crashes.

We recommend to deactivate the system in the vehicle personalization in the following cases:

- when towing a trailer or caravan
- when carrying long objects on roof bars or a roof rack
- when the vehicle is being towed
- when performing any maintenance with ignition on
- when the vehicle is fitted with snow chains
- when a spare wheel is fitted that is smaller than the other wheels
- before using an automatic car wash
- before placing the vehicle on a rolling road in a workshop

- if the windscreen has been damaged close to the camera
- if the brake lights are not working

Fault

If the system does not work properly or is not available, e.g. during the initialization,

 illuminates on the cluster.

In the event of a fault,  illuminates on the cluster, a message is displayed and an audible signal is given. Consult a workshop.

 illuminates on the cluster accompanied by a message indicating that the sensors or the camera may be covered. Stop the vehicle and check, if

these needs to be cleaned. If  still illuminates after cleaning the camera, consult a workshop.

 may also illuminate if the infotainment system has an issue.

If  illuminates on the cluster after the engine has been switched off and then restarted, consult a workshop.

⇒ page 58

Forward Collision Warning (FCW)

The forward collision warning warns the driver if there is a risk of collision with the vehicle ahead, with a cyclist or a pedestrian.

Warning

Forward collision warning is just a warning system and does not apply the brakes. When approaching a vehicle ahead too rapidly, there may not be enough time to avoid a collision.

The driver accepts full responsibility for the appropriate following distance based on traffic, weather and visibility conditions.

The complete attention of the driver is always required while driving. The driver must always be ready to take action and apply the brakes.

Activation

Forward collision warning operates from 8 km/h to 80 km/h when a pedestrian or a cyclist has been detected.

Forward collision warning operates from 8 km/h to 135 km/h when a moving or stationary vehicle has been detected.

Alerting the driver

 flashes on the cluster and a warning chime sounds accompanied by a message, when a collision is imminent and immediate driver's action is required.

Caution

The colour lighting of this control indicator does not correspond to local traffic laws on following distance. The driver bears full responsibility for maintaining safe following distance according to applicable traffic rules, weather and road conditions etc. at all times.

Deactivation

The system can only be deactivated by deactivating the active emergency braking in the vehicle personalization.

System limitations

Forward collision warning is designed to warn on vehicles, cyclists and pedestrians, but may react also to other objects.

The system performance may be degraded or not available in the following cases:

- front camera is covered with snow, ice, slush, mud or dirt

- windscreen damaged or smeared, with blurred view or covered with foreign items, e.g. stickers
- front camera out of its regular position
- automatic braking not available, e.g. brake discs cooling going on
- brake pedal continuously used for a long time, e.g. on a long downhill road
- winding or hilly roads
- system initialization process after battery disconnection
- dazzling light, e.g. caused by the sun or artificial illumination is shining directly into the camera lens
- adverse environmental conditions, e.g. rain, fog, or snow
- vehicle ahead creating road spray

After an impact or when damages are visible have the vehicle checked by a workshop.

The system performance may be affected by:

- Electronic Stability Control and Anti-Slip Regulator (ASR) in progress
- vehicle battery voltage out of range
- wet road reflecting lights
- close vehicles ahead

- tractors, muddy vehicles or vehicles with a trailer
- banked roads
- poor lighting conditions
- sudden lighting changes
- vehicle modifications, e.g. tires
- vehicle overloaded

Vehicle Stability Assistance System

Anti-Slip Regulator (ASR)

Anti-slip regulation (or traction control) optimises traction by using engine braking and by applying the brakes on the driving wheels to avoid one or more wheels spinning. It also enhances the vehicle's directional stability. If there is a difference between the vehicle's trajectory and the path desired by the driver, the dynamic stability control system automatically uses engine braking and the brakes on one or more wheels to return the vehicle to the desired path, within the limits of the laws of physics.

These systems are activated automatically every time the vehicle is started.

When the ASR system operates  flashes.

Malfunction

In the event of a malfunction,  lights up on the instrument panel, accompanied by the display of a message and an audible signal.

Seek the assistance of a workshop.

Warning

ASR/DSC

These systems enhance safety during normal driving, but should not encourage the driver to take extra risks or drive at high speed.

It is in conditions of reduced grip (rain, snow, ice) that the risk of loss of grip increases. It is therefore important for your safety to keep these systems activated in all conditions, and particularly in difficult conditions.

Correct operation of these systems depends on compliance with the manufacturer's recommendations relating to the wheels (tyres and rims), braking and electronic components, as well as the assembly and repair procedures provided by dealers.

In order to ensure that these systems remain effective in wintry conditions,

the use of snow or all-season tyres is recommended. All four wheels must be fitted with tyres approved for your vehicle.

Vehicles With Deactivation Menu

ASR can be deactivated in the cluster menu via the steering wheel control. Instrument Cluster ⇒ page 57
Deactivation is confirmed by the

illumination of  and a message in the instrument cluster.

ASR is reactivated automatically when exceeding a vehicle speed of 50 km/h and every time the ignition is switched back on. ASR can be reactivated manually at vehicle speed below 50 km/h.

Electronic Stability Control (ESC)

Electronic Stability Control (ESC) improves driving stability when necessary, regardless of the type of road surface or tyre grip.

As soon as the vehicle starts to swerve (understeer / oversteer), engine output is reduced and the wheels are braked individually.

ESC operates in combination with the Anti-Slip Regulator (ASR) system.

It prevents the driven wheels from spinning.

The Anti-Slip Regulator (ASR) system is a component of the ESC.

The Anti-Slip Regulator (ASR) system improves driving stability when necessary, regardless of the type of road surface or tyre grip, by preventing the driven wheels from spinning.

As soon as the driven wheels starts to spin, engine output is reduced and the wheel spinning the most is braked individually. This considerably improves the driving stability of the vehicle on slippery road surfaces.

ESC and Anti-Slip Regulator (ASR) system are operational after each engine

start as soon as the control indicator  extinguishes.

When ESC and Anti-Slip Regulator

(ASR) system operate,  flashes.

After reconnecting the vehicle battery, the system needs a recalibration by driving a short distance.

Warning

Do not let this special safety feature tempt you into taking risks when driving.

Adapt speed to the road conditions.



ESC and Anti-Slip Regulator (ASR) system can be deactivated if it is

required: press .

The LED in the button  illuminates. A status message appears in the Driver Information Centre when ESC and Anti-Slip Regulator (ASR) system are deactivated.

ESC and Anti-Slip Regulator (ASR) system are reactivated by pressing the  button again, by applying the brake or in the case that the vehicle is driven faster than 50 km/h.

The LED in the button  extinguishes when ESC and Anti-Slip Regulator (ASR) system are reactivated. ESC and Anti-Slip Regulator (ASR) system are also reactivated the next time the ignition is switched on.

Fault

If there is a fault in the system, the control indicator  illuminates continuously and a message appears in the Driver Information Centre. The system is not operational. Have the cause of the fault remedied by a workshop.

Selective Ride Control**Caution**





The vehicle is designed to drive principally on-road, but it also enables driving off-road occasionally. However, do not drive on terrain where the vehicle could be damaged due to obstacles, such as stones among others and on terrain with steep inclines and poor grip. Do not cross waters.

Caution

When driving off-road, sudden motion and manoeuvres can cause a collision or losing control.

Selective ride control is designed to optimise traction in low-grip conditions (snow, mud and sand).

It adapts to the terrain by acting on the front wheels. In doing so this saves the weight normally associated with a more conventional four wheel drive system. Selective ride control allows to choose between five driving modes by turning the control:

- ESC off mode 
- standard mode 
- snow mode 
- mud mode 
- sand mode 

An LED illuminates and a status message appears in the Driver Information Centre to confirm the chosen mode

ESC off mode

The ESC and Anti-Slip Regulator (ASR) are deactivated in this mode. ESC and Anti-Slip Regulator (ASR) are reactivated automatically from 50 km/h or if the ignition is switched on.

Standard mode

This mode is calibrated for a low level of wheel spin, based on the different types of grip generally encountered in normal day to day driving.

Everytime the ignition is switched off, the system is automatically reset to this mode.

Snow mode

This mode adapts to the grip conditions encountered by each wheel when starting. When advancing, the system optimises wheel spin to guarantee the best acceleration based on the available traction. Recommended in cases of deep snow and steep inclines. This mode is active up to a speed of 50 km/h.

Mud mode

This mode allows considerable wheel spin at start-up for the wheel with the least grip, this removes mud and reestablishes traction. Simultaneously, the wheel with the most grip is provided with the most torque possible. This mode is active up to a speed of 80 km/h.

Sand mode

This mode allows a small amount of simultaneous wheel spin on the two drive wheels, enabling the vehicle to advance and reduce the risk of sinking.

This mode is active up to a speed of 120 km/h.

Caution

Do not use the other modes on sand as the vehicle may become stuck.

Sport mode

Sport mode adapts the settings of some vehicle systems to a sportier driving style.

Activation

Press **SPORT** when engine is running. LED in the button illuminates when sport mode is active and a status message appears in the Driver Information Centre.

Deactivation

Briefly press **SPORT**. Sport mode is deactivated the next time the ignition is switched on.

Side Blind Spot Alert (SBSA)

Warning

Side blind spot alert is only a lane changing aid and does not replace

driver vision. Side blind spot alert does not detect:

- vehicles approaching very rapidly
- pedestrians or animals
- non-moving objects, e.g. stationary vehicles, street lights, road signs, etc.

Failure to use proper care when changing lanes may result in damage to the vehicle, injury, or death. Always check the outside and rearview mirrors, glance over your shoulder, and use the turn signal before changing lanes.

Activation

The system can be activated in the vehicle settings menu on the \Rightarrow by using the steering wheel controls.

Functionality

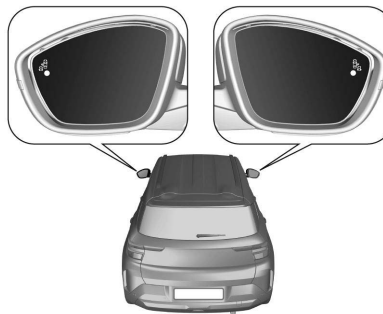

When the system detects a vehicle in the side blind zone while driving forwards, an LED will illuminate in the relevant exterior mirror. If the turn lights of the relevant side are activated, the LED will flash. The LED comes on immediately when being passed.

The LED comes on after a delay when passing another vehicle slowly.

Operation conditions

The following conditions must be fulfilled for proper operation:

- all vehicles are moving in the same direction and in adjacent lanes
- the vehicle speed is between 30 and 140 km/h
- passing a vehicle with a speed difference of less than 15 km/h
- another vehicle is passing with a speed difference of less than 15 km/h
- no plug is connected to the power outlet of the trailer hitch
- the sensors are not covered by mud, ice or snow
- the warning zones in the door mirrors or the detection zones on front and rear bumper are not covered with adhesive labels or other objects
- the traffic flow is normal

- driving on a straight or slightly curved road

No alert will be given in the following situations:

- in the presence of non-moving objects, e.g. parked vehicles, barriers, street lights, road signs
- in very dense traffic, when moving vehicles might be confused with a stationary object
- with vehicles moving in the opposite direction
- driving on a winding road or a sharp corner
- when passing or being passed by a very long vehicle, e.g. lorry, coach, which is at the same time detected at the rear in the blind spot angle and present in the driver's forward field of vision
- when passing too quickly

Deactivation

The system can be deactivated in the vehicle personalization on the cluster, accessing the menu with steering wheel controls.

The state of the system is memorized when switching off the ignition.

The system is switched off automatically when attaching a trailer or bike carrier to the trailer hitch.

Due to adverse weather conditions such as heavy rain, false detections may occur.

Fault

In the event of a fault,  illuminates on the cluster, accompanied by a display message.

Seek the assistance of a workshop.

Lane Departure Warning (LDW)

The lane departure warning system supports the driver to avoid unintended leaving of the lane. The front camera the lane markings between which the vehicle is driving. If the vehicle crosses a road edge or a lane marking, the system warns the driver.

Unintended lane departure is not assumed by the system when the turn lights are operated and during few seconds after turn lights have been switched off.

No warning will be issued with a dynamic driving, i.e. pressure on the brake or accelerator pedal or heavy steering.

When the system recognizes an unintended lane departure,  illuminates and a corresponding message is displayed.

Operation conditions

For a correct operation of the system, the following preconditions have to be fulfilled:

- vehicle speed must be between approx. 65 km/h and 180 km/h
- the turn lights are not activated
- no dynamic driving, i.e. pressure on the brake or accelerator pedal
- lane markings can be clearly detected by the system
- the vehicle is not driven in a tight corner
- no system fault is present which prevents corrections

Warning

This system is a driving aid that cannot, in any circumstances, replace the need for vigilance on the part of the driver.

Activation

Depending on version, the system is automatically active by default every time

the engine is started, even if it was deactivated during the last ignition cycle. For further information see ⇨ page 116



If the system is activated, the LED in the button is not illuminated. To activate the system when the system is deactivated, press the button.

Deactivation

To deactivate the system, press the button until LED in the button is illuminated.

System limitations



The system performance may be affected by:

- covered camera by snow, ice, slush, mud, dirt, or affected by windscreen damage or foreign items, e.g. stickers

- close vehicles ahead
- banked roads
- winding or hilly roads
- poor lighting conditions
- sudden lighting changes
- dazzling light, e.g. caused by the sun or artificial illumination is shining directly into the camera lens
- adverse environmental conditions, e.g. heavy rain, fog, or snow
- vehicle modifications, e.g. tires
- roads with poor or no lane markings

Fault

In the event of a fault,  illuminates on the cluster. Consult a workshop.

 illuminates on the cluster accompanied by a message indicating that the front camera may be covered. Stop the vehicle and check, if the camera needs to be cleaned. If  still illuminates after cleaning the camera, consult a workshop.

Lane Keeping Assist (LKA)

Lane keeping assist supports the driver to avoid unintended leaving of the lane. The front camera observes the lane markings between which the vehicle is driving.

If the vehicle approaches a lane marking, the steering wheel is gently turned so that the vehicle turns back into the lane. The driver will notice a turning movement of the steering wheel.

Turn the steering wheel in same direction, if the system does not steer sufficiently. Turn the steering wheel gently into opposite direction, if a lane change is intended.

When the system steers to correct the trajectory of the vehicle,  flashes on the cluster.

Lane keeping assist does not continuously steer the vehicle. Unintended lane departure is not assumed by the system when the turn lights are operated and during few seconds after the turn lights have been switched off.

The system will inform the driver with a message and a chime if there is an ongoing correction for more than ten seconds. If the driver is still unable

to keep the vehicle in the lane, the correction interrupts after a short time. When hands-off driving is detected during a correction within a rolling interval of 180 seconds, the system intervenes:

Intervention 1:  flashes until the end of the intervention.

Intervention 2:  flashes and a warning chime sounds until the end of intervention but for at least one second.

Further interventions:  flashes continuously and the warning chime sounds 10 seconds longer than the previous chime.

A lane departure warning on the cluster alerts when the system cannot hold the vehicle within the lane and immediate driver's action is required.

Note

The system might be inactive if it detects lanes which are too narrow, too wide or too curved.

For a correct operation of the system, the following preconditions have to be fulfilled:

- vehicle speed must be between approx. 65 km/h and 180 km/h

- the turn lights are not activated
- the Electronic Stability Control is activated and not in operation
- no plug is connected to the power outlet of the trailer hitch
- no dynamic driving, i.e. pressure on the brake or accelerator pedal
- lane markings can be clearly detected by the system
- no temporary spare wheel is used
- the vehicle is not driven in a tight corner
- no system fault is present which prevents corrections

Depending on version, only lane departure warning system is active, when a system fault is present, a spare wheel is used, Electronic Stability Control is not activated or e.g. a trailer is attached.

Activation

Depending on version, the system is automatically active by default every time the engine is started, even if it was deactivated during the last ignition cycle. For further information see ⇨ page 116.



If the system is activated, the LED in the button is not illuminated. To activate the system when the system is deactivated, press the button.

Deactivation

To deactivate the system, press the button until the LED is illuminated.

System limitations

The system performance may be affected by:

- covered camera by snow, ice, slush, mud, dirt, or affected by windscreen damage or foreign items, e.g. stickers
- heavy or unequally distributed loading
- close vehicles ahead
- banked roads

- winding or hilly roads
- poor lighting conditions
- sudden lighting changes
- dazzling light, e.g. caused by the sun or artificial illumination is shining directly into the camera lens
- adverse environmental conditions, e.g. heavy rain, fog, or snow
- vehicle modifications, e.g. tires
- wrong tire pressure
- roads with poor or no lane markings

A warning message may appear when the vehicle is travelling in a long straight lane on a smooth road surface even if the driver is holding the steering wheel properly.

Deactivate the system if the system is disturbed by tar marks, shadows, road cracks, temporary or construction lane markings, or other road imperfections.



Warning

Always keep your attention on the road and maintain proper vehicle position within the lane, otherwise vehicle damage, injury or death could occur. The system may not keep the vehicle in the lane or give an alert, even if a lane marking is detected.

The steering of the system may not be sufficient to avoid a lane departure. The system may not detect hands-off driving due to external influences (road condition and surface, weather etc). The driver has full responsibility to control the vehicle and is always required to keep the hands on the steering wheel while driving. Using the system on slippery roads could cause loss of control of the vehicle and a crash. Switch the system off.

Fault

In the event of a fault,  illuminates on the cluster. Consult a workshop.

 illuminates on the cluster accompanied by a message indicating that the front camera may be covered. Stop the vehicle and check, if the camera needs to be cleaned. If  still illuminates after cleaning the camera, consult a workshop.

Parking Assist

General information

The rear system is deactivated when a plug is connected to the power outlet of the trailer hitch.

Warning

The driver bears full responsibility for the parking manoeuvre. Always check the surrounding area when driving backwards or forwards while using parking assist system.

Front-rear parking assist

The front-rear parking assist measures the distance between the vehicle and obstacles in front and behind the vehicle. It informs and warns the driver by giving audible signals and display indication.



The system operates with ultrasonic parking sensors in the rear and front bumper.

Activation

When a forward gear has been engaged, the front parking assist is activated, as soon as an obstacle is detected in the front and the speed of the vehicle is below 13 km/h.

When the reverse gear has been engaged, the rear parking assist and the front parking assist are activated.

After engaging the reverse gear, an audible signal is given and a display indication will be shown. If no audible signal is given, the display indication is not shown or a warning message appears, the system has a failure.

Deactivation

The rear parking assist is switched off when reverse gear is disengaged. The front parking assist is switched off at a speed above 13 km/h. The front parking assist reactivates only at a speed below 10 km/h.

Indication

As soon as an obstacle gets closer to the vehicle, an audible signal is given and ^{P)}Δ may flash. The interval between the sounds becomes shorter as the vehicle gets closer to that obstacle. When the distance is less than approx. 35 cm, the sound is continuous and is fixed. Audible signals are given from the cluster.

No audible signals are given, if:

- the vehicle stops for more than three seconds in position **D** or in forward gear

- the automatic transmission is in **P** position
- no further obstacles are detected

Additionally, the distance to obstacles is displayed by changing distance lines in the Information Display ⇔

If the vehicle has no radio or Information Display and an obstacle gets closer, only the ^{P)}Δ flashes and the respective audible signal sounds.

System limitations

In the event of a fault or if the system does not work temporarily, e.g. because of high external noise level or other interference factors, ^{P)}Δ illuminates on the cluster, a message is displayed and a warning chime sounds.

In the case of a permanent fault, seek the assistance of a workshop.

Note

Make sure that the front number plate is properly mounted, vertically and horizontally centred and the sensors are firmly in place. The performance of the parking assist will be reduced if the license plate is bent or a license plate support is used.

Warning

Under certain circumstances, various reflective surfaces on objects or clothing as well as external noise sources may cause the system to fail to detect obstacles.

Special attention must be paid to low obstacles which can damage the lower part of the bumper.

Caution

In the case of a severe failure of the vehicle with the need to stop the vehicle, the system is deactivated.

In the case of a gearbox failure, the parking assist system is not active, when reverse gear is engaged.

In the case of a sound emission failure in the Information Display, the audible signals may not be given.

The performance of the system can be reduced when the sensors are covered, e.g. by ice or snow.

The performance of the parking assist system may be limited or the functionality may not be available at all

if  illuminates or if the image shown on the Information Display is frozen or if the screen is black.

The performance of the parking assist system can be reduced due to heavy loading.

Special conditions apply if there are taller vehicles in the vicinity (e.g. off-road vehicles, mini vans, vans). Object identification and correct distance indication in the upper part of these vehicles cannot be guaranteed.

Caution

Objects with a very small reflection cross-section, e.g. objects of narrow size or soft materials, may not be detected by the system.

Parking assist systems do not detect objects outside the detection range, e.g. below the bumper or underneath the vehicle.

During a reverse parking manoeuvre, the system does not consider a mounted coupling ball bar. The driver has to consider this additional length.

Note

It is possible that the sensor detects a non-existing object caused by echo disturbance from external acoustic noise or mechanical misalignments (sporadic false warnings may occur).

Make sure that the front number plate is properly mounted (not bent and no gaps

to the bumper on the left or right side) and the sensors are firmly in place. The performance of the parking assist may be reduced if the license plate is bent or a license plate support is used.

Low curbs and surface irregularities, e.g. on construction zones, are not detected by the system. The driver accepts responsibility.

Rear Vision Camera (RVC)

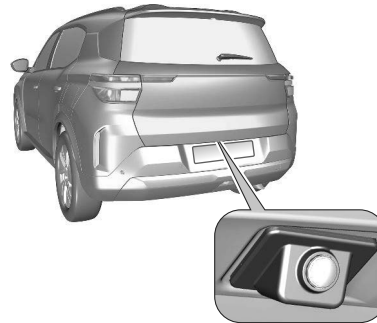

The rear view camera assists the driver when reversing by displaying a view of the area behind the vehicle. It allows views of the vehicle's surroundings to be

displayed as a nearly 135° picture in the Information Display.

⚠ Warning

The rear view camera does not replace driver vision. Note that objects that are outside the camera's field of view and the parking assist sensors, e.g. below the bumper or underneath the vehicle, are not displayed.

Do not reverse or park the vehicle using only the rear view camera.

Always check the surrounding of the vehicle before and during driving.

The system uses:

- rear view camera, mounted above the rear number plate
- ultrasonic parking sensors in the rear bumper

The screen in the Information Display is divided into three parts:

- right side: there is a fixed menu and a representation of the vehicle
- middle part: part consists of a standard view
- left side: there are the volume settings of the radio

The parking sensors complete the information on the view from above the vehicle.

The area displayed by the rear view camera is limited. Displayed images may be further or closer than they appear.

Activation

The rear view camera is activated when the reverse gear is engaged.

Standard view



The area behind the vehicle is displayed in the screen. The vertical lines represent the width of the vehicle with mirrors unfolded.

1. The horizontal red line represents a distance of about 30 cm beyond the edge of your vehicle's rear bumper.

2. The horizontal yellow line represents a distance of about 1 m beyond the edge of your vehicle's rear bumper.
3. The horizontal green line represents a distance of about 2 m beyond the edge of your vehicle's rear bumper.

These distances may vary depending on the weight of the vehicle.

Deactivation

The rear view camera is deactivated when rear gear is disengaged.

System limitations

Warning

For optimal operation of the system, it is important to keep the lense of the camera, which is located in the bumper between the number plate lights, always clean.

Rinse the lenses with water and wipe with a soft cloth.

Do not clean the lenses with a steam-jet or high-pressure jet cleaner.

The rear view camera may not operate properly when:

- the surrounding is dark

- dazzling light, e.g. caused by the sun or artificial illumination is shining directly into the camera lens
- weather limits visibility, such as fog, rain, or snow
- covered camera by snow, ice, slush, mud, dirt, or affected by windscreen damage or foreign items, e.g. stickers
- clean the lense using the washer nozzle as described.
- a plug is connected to the power outlet of the trailer hitch
- vehicle had a rear end accident
- extreme temperature changes

Driver Drowsiness Detection (DDD)

The driver drowsiness detection monitors the vigilance of the driver. Monitoring the vigilance of the driver is based on the changes in the driver's steering behavior. The system cannot replace the need for vigilance on the part of the driver. Taking a break is recommended as soon as



feeling tired. Do not drive when feeling tired.

Activation or Deactivation

Depending on version, the system is automatically active by default every time the engine is started, even if it was deactivated during the last ignition cycle. For further information see ⇒ page 116
The system can be activated or deactivated via the cluster by using the steering wheel controls.
⇒ page 57

Driver drowsiness detection

Driver drowsiness detection operates from 65 km/h to 180 km/h. The system monitors the steering movements based on the driver's input. The system is initialized when driving five minutes at a speed above 70 km/h. If the steering inputs of the driver suggest a certain level of drowsiness or inattention by the driver, the system triggers the first level of alert.

The driver is notified by  and an audible signal is given. A second level of warning is issued when the driver is highly drowsy, then the system triggers a new alert with , accompanied by a more pronounced audible signal. In certain driving conditions such as poor

road surface or strong winds etc., the system may give alerts independent of the driver's level of vigilance. The driver drowsiness detection is reinitialized in the following situations:

- the ignition has been switched off for a few minutes
- the driver's seat belt has been unfastened and the driver's door has been opened
- If the vehicle is at a standstill a long time with engine running

System limitations

In the following situations, the system may not operate properly or even not operate at all:

- the front camera has a failure
- the steering wheel system has a failure
- lane keep assist is active

Fault

In the event of a fault,  illuminates on the cluster. Consult a workshop.

Cruise Control

The system maintains the vehicle speed at the preset speed by the driver, without any action on the accelerator pedal.

The cruise control can memorize and maintain speeds above 40 km/h. For vehicles with automatic transmission additionally position **D** or the second or a higher gear in position **M** must be engaged.

Deviations from the memorized speeds may occur when driving uphill or downhill.

The preset speed can be exceeded temporarily by pressing the accelerator pedal firmly.

The status and preset speed is displayed on the cluster.

Only use the cruise control if a constant speed can be maintained.
Control indicator ⇒

Switching on the system



Press  once to activate the Cruise Control function.

Activation of the functionality Setting speed by the driver

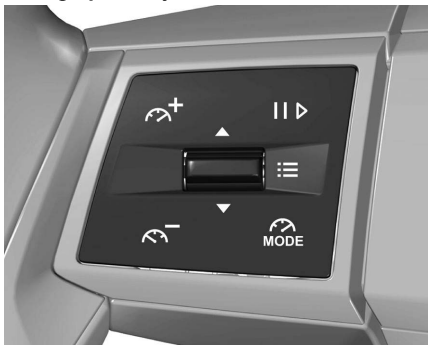

If the system is active, the preset speed can be changed by pressing  to

increase or  to decrease the speed. A short press changes speed by 1 km/h, a long press changes speed by 5 km/h. The speed value is indicated on the cluster.

Exceeding the set speed

It is always possible to drive faster than the set speed by depressing the accelerator pedal. When the accelerator

pedal is released, the vehicle returns to the memorized speed.

Deactivation of the functionality

Press , cruise control is in pause mode and the symbol illuminates. The vehicle is driven without cruise control. Cruise control is deactivated, but not switched off. The last memorized speed remains in memory for later speed resume.

Cruise control is deactivated automatically when:

- The brake pedal is depressed
- Vehicle speed is below 40 km/h
- The Anti-Slip Regulator (ASR) system or Electronic Stability Control is operating
- The selector lever is in N

Resume Memorized speed

Press cruise control + or - or **RESUME** button.

Switching off the system

Press : the cruise control mode is deselected and the cruise control indication extinguishes on the cluster.

Pressing  two times to activate the speed limiter deactivates the cruise control.

Switching off the ignition cancels any memorized speed value.

Fault

In the event of a cruise control fault, the speed is cleared resulting in flashing of the dashes.

Have the system checked by a workshop.

Speed Limiter

The speed limiter prevents the vehicle from exceeding a preset maximum speed. The maximum speed can be set at speeds between 30 km/h and 180 km/h. The driver can accelerate the vehicle up to the preset speed. Deviations from the limited speed may occur when driving downhill. The preset speed can be exceeded temporarily by pressing the accelerator pedal firmly. The status and preset speed limit are displayed on the cluster.



Switching on the system





Press  twice to activate speed limiter.

Activation of the functionality Setting speed by the driver



The preset speed can be changed by pressing  to increase or  to decrease the speed. A short press changes speed by 1 km/h, a long press changes speed by 5 km/h.

Press  or  to activate.

Press  to activate within the same ignition cycle.

Exceeding the speed limit

In the event of an emergency, it is possible to exceed the speed limit by depressing the accelerator pedal firmly to the final point. In this case, the preset speed value flashes.

Release the accelerator pedal and the speed limiter function is reactivated once a speed lower than the limit speed is obtained.

Deactivation of the functionality

Press , speed limiter is in pause mode.

The vehicle is driven without speed limiter.

Speed limiter is deactivated, but not switched off. Last stored speed remains in memory for later speed resume.

Resume limit speed

Press  or .

Switching off the system

Press , the speed limiter mode is deselected and the speed limit indication extinguishes.

Fault

In the event of a speed limiter fault, the speed is cleared resulting in flashing of the dashes.

Have the system checked by a workshop.

Tire Deflation Detection System

The tire deflation detection system continually checks the rotation speed of all four wheels and warns on low tire pressure condition once vehicle is driving. This is achieved by comparing tire rolling circumference with reference values and further signals.

If a tire loses pressure the control

indicator  illuminates and a warning message is displayed on the cluster.

Control indicator ⇨ page 51

In this case reduce speed, avoid sharp cornering and strong braking.

Stop at next safe opportunity and check tire pressure.

After adjusting tire pressure initialize the system to extinguish the control indicator and restart the system.

If the failure continues to be displayed, contact a workshop. The system is inoperable when the ABS or Electronic Stability Control has a malfunction or a temporary spare wheel is used. Once the tire has been refitted, check the tire pressure with cold tires and initialize the system.

Caution

Tire deflation detection system warns just about low tire pressure condition and does not replace regular tire maintenance by the driver.

System initialization

After tire pressure correction or wheel change, the system must be initialized to learn new circumference reference values:

1. Always ensure that all four tires have correct tire pressure ⇒ page 170
2. Apply parking brake.

3. Initialize the system via the Information Display ⇒ page 58
4. Reset is confirmed by a message.

After initialization the system automatically calibrates to new tire pressures during driving. After a longer drive the system will adopt and monitor new pressures.

Always check tire pressure with cold tires.

The system has to be reinitialized when:

- Tire pressure has been changed.
- Load condition has been changed.
- Wheels have been swapped or exchanged.

The system will not warn instantaneously on a tire blow out or a rapid deflation. This is due to required calculation time.

Traffic Sign Assist (TSA)

Warning

The actual traffic sign always takes priority over the traffic sign displayed on the cluster.

Speed limit system (compliant with the European General Safety Regulation)

This system displays permanently speed limit information on the cluster independent of the vehicle speed. Providing the speed limit information involves the following systems, depending on version:

- camera at the top of the windscreen
- vehicle's integrated navigation system
- telematics service

If travelling on a road with no speed restrictions, e.g., on German motorways, the following sign is displayed:



If no speed limit information can be provided, the following sign is displayed:

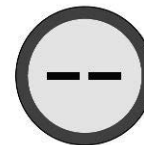

If a new speed limit is provided, a confirmation chime is given, when the



option is activated by the driver, using the menu on the cluster. The confirmation chime is deactivated by default on the cluster, to activate use the steering wheel controls.

⇒ page 58

If driving at a speed of at least 20 km/h and exceeding the speed limit, the speed limit displayed on the cluster flashes after some time and an audible signal is given after some time. Time of occurrence varies. Both flashing and audible signal are terminated after the speed gets under the speed limit detected.





Activation / deactivation

Press and hold  to deactivate the audible signal. To activate the audible signal press . Due to legal

requirements, the audible signal can only be deactivated by clicking on  until the next time the ignition is switched on.

If the audible signal is deactivated,  illuminates for a few seconds.

In case of a failure,  illuminates permanently. Consult a workshop.

In case of partial behavior (camera or navigation data unavailable)  illuminates until the unavailability ends, but the speed plate indications, audible and visual warnings will remain working.

⇒ page 131

⇒ page 132

Operating conditions

To provide country-specific speed limit information, the vehicle needs to identify the country it is currently in. The country is automatically selected, using telematic box/navigation information.

To get valid speed limit information, the vehicle's current position is sent via the telematics unit and it is immediately deleted after processing.

Tracking of the vehicle position is not possible at any time.

This is not impacted by the privacy settings of Opel Connect.

Note

It is possible to report a permanent speed limit misinformation on our website.

Updating data

To maintain the performance of the system, the vehicle software and the navigation map should be updated in periodical intervals.

For vehicle software update consult a workshop.

System limitations

Traffic sign assist may not operate properly when:

- driving on winding or hilly roads
- driving with snow chains
- the area of the windscreen, where the front camera is located, is not clean or affected by foreign items, e.g. stickers
- the visibility is limited because of the weather, such as fog, rain, or snow
- the vehicle ahead is creating road spray
- dazzling light, e.g. caused by the sun or artificial illumination is shining directly into the camera lens
- speed limitation is painted on the surface of the road

- traffic signs are completely or partially covered or difficult to discern
- traffic signs are incorrectly mounted or damaged or have been removed
- traffic signs do not comply with the Vienna Convention on Road Signs and Signals
- depending on version, the navigation map data may be outdated

Caution

The system is intended to help the driver within a defined speed range to recognise certain traffic signs. Do not ignore traffic signs which are not displayed by the system.

Do not let this special feature tempt you into taking risks when driving.



Always adapt speed regarding road, traffic and weather conditions.

The driver assistance systems do not relieve the driver from full responsibility for vehicle operation.

When driving abroad make sure the vehicle uses the speed unit of the respective country. If necessary, select the correct units on the cluster.

Fault

In the event of a fault,  illuminates on the cluster. Consult a workshop.

 illuminates on the cluster accompanied by a message indicating that the front camera may be covered. Stop the vehicle and check, if the camera needs to be cleaned. If  still illuminates after cleaning the camera, consult a workshop.

Vehicle Care

| | |
|---|-----|
| General Information..... | 137 |
| Accessories And Vehicle Modifications..... | 137 |
| Vehicle Storage..... | 138 |
| End-Of-life Vehicle Recovery..... | 139 |
| Vehicle Checks..... | 140 |
| Performing Work..... | 140 |
| Bonnet..... | 140 |
| Engine Oil..... | 141 |
| Engine Coolant..... | 142 |
| Washer Fluid..... | 143 |
| Brakes..... | 143 |
| Brake Fluid..... | 143 |
| Vehicle Battery..... | 143 |
| Wiper Blade Replacement..... | 145 |
| Bulb Replacement..... | 145 |
| Light-Emitting Diode (LED) Headlights And Lights..... | 146 |
| Front Fog Lights..... | 146 |
| Rear Fog Lights..... | 146 |
| Tail Lights..... | 146 |
| Centre High-Mounted Brake Light..... | 147 |
| Number Plate Light..... | 147 |
| Interior Lights..... | 147 |
| Electric System..... | 147 |
| Fuses..... | 147 |
| Vehicle Tools..... | 147 |
| Wheels And Tires..... | 147 |
| Winter Tires..... | 147 |
| Tire Designations..... | 148 |

| | |
|-----------------------------------|-----|
| Tire Pressure..... | 148 |
| Tread Depth..... | 149 |
| Changing Tire And Wheel Size..... | 149 |
| Wheel Covers..... | 149 |
| Tire Chains..... | 150 |
| Tire Repair Kit..... | 150 |
| Wheel Changing..... | 153 |
| Spare Wheel..... | 154 |
| Jump Starting..... | 157 |
| Towing..... | 158 |
| Towing The Vehicle..... | 158 |
| Towing Another Vehicle..... | 159 |
| Appearance Care..... | 160 |
| Exterior Care..... | 160 |
| Interior Care..... | 161 |
| Floor Mats..... | 161 |

General Information

Accessories And Vehicle Modifications

We recommend the use of genuine parts and accessories and factory approved parts specific for this vehicle type. We cannot assess or guarantee reliability of other products - even if they have a regulatory or otherwise granted approval. Any modification, conversion or other changes made to standard vehicle specifications (including, without limitation, software modifications, modifications of the electronic control units) may invalidate the warranty offered by Opel.

Furthermore, such changes may affect driver assistance systems, may impact fuel consumption, CO₂ emissions and other emissions of the vehicle and cause the vehicle to no longer conform to the operating permit, impacting the validity of your vehicle registration.

Caution

Access to the diagnostic socket associated with the on-board electronics is reserved for qualified technicians and approved tools.

Caution

When transporting the vehicle on a train or on a recovery vehicle, the mud flaps might be damaged.

Mobile phones and CB radio equipment

The vehicle specific installation instructions and the operating guidelines of the mobile phone and hands-free manufacturer must be observed when installing and operating a mobile telephone. Failure to do so could invalidate the vehicle type approval. Recommendations for fault-free operation:

- Professionally installed exterior antenna to obtain the maximum range possible.
- Maximum transmission power 10W.
- Installation of the phone in a suitable spot, consider the area in which the airbag inflates ⇒ page 24

Seek advice on predetermined installation points for the external antenna or equipment holder and ways of using devices with a transmission power exceeding 10W.

Use of a hands-free attachment without external antenna with mobile telephone

standards GSM 900/1800/1900 and UMTS is only permitted if the maximum transmission power of the mobile telephone is 2W for GSM 900 or 1W for the other types.

For reasons of safety, do not use the phone while driving. Even use of a hands-free set can be a distraction while driving.

Warning

Operation of radio equipment and mobile telephones which fail to meet above mentioned mobile telephone standards is only permitted using an antenna located outside of the vehicle.

Caution

Mobile telephones and radio equipment may lead to malfunctions in the vehicle electronics when operated inside the vehicle with no exterior antenna, unless the above mentioned regulations are observed.

Vehicle Storage

Storage for a long period of time

If the vehicle is to be stored for several months:

- Wash the vehicle.

- Have the wax in the engine compartment and underbody checked.
- Clean and preserve the rubber seals.
- ICE/Hybrid 48 V: Fill up fuel tank completely
- ICE/Hybrid 48 V: Change the engine oil
- Drain the washer fluid reservoir.
- Check the coolant antifreeze and corrosion protection.
- Adjust tire pressure to the value specified for full load.
- Park the vehicle in a dry, well ventilated place. Engage first or engage **P**. Prevent the vehicle from rolling.
- Do not apply the parking brake.
- Switch off ignition and all electrical consumers.
- Wait four minutes
- Open the bonnet, close all doors and lock the vehicle.

Anti-theft alarm system ⇒ page 9

Storage BEV up to four weeks

Plug in the charging cable.

Storage BEV up to twelve months

- Discharge the high voltage battery until 30 percent remain on the battery range indicator (battery symbol) on the cluster.
- Do not plug in the charging cable.
- Always store the vehicle in a place with temperatures between -10 °C and 30 °C.
- Vehicle storage at extreme temperatures may cause damage to the high voltage battery.
- Remove the black negative (-) cable from the 12 V vehicle battery and attach a trickle charger to the vehicle battery terminals or keep the 12 V vehicle battery cables connected and trickle charge from the positive (+) and negative (-) terminals in the engine compartment.
- Every three months, check the high voltage battery's state of charge. If the state of charge is below 30 percent, recharge the high voltage battery to 30 percent.

Putting back into operation

When the vehicle is to be put back into operation:

1. Connect the clight to the positive

terminal of the vehicle battery in the engine compartment.

2. Initialize the power windows ⇒ page 13

- Check tire pressure.
- Fill up the washer fluid reservoir.
- ICE / Hybrid 48 V: Check the engine oil level.
- Check the coolant level.
- Fit the number plate if necessary.

For further information see propulsion types ⇒ page 3.

End-Of-Life Vehicle Recovery

Information on end-of-life vehicle recovery centres and the recycling of end-of-life vehicles is available on our website, where legally required. Only entrust this work to an authorized recycling centre.



High voltage battery

The high voltage battery is designed for the life of the vehicle if the recommendations are followed. If it becomes necessary to replace the high voltage battery, contact a workshop for instructions on its disposal. Improper disposal carries the risk of severe burns, electric shock, and damage to the environment.

Vehicle Checks

Performing Work

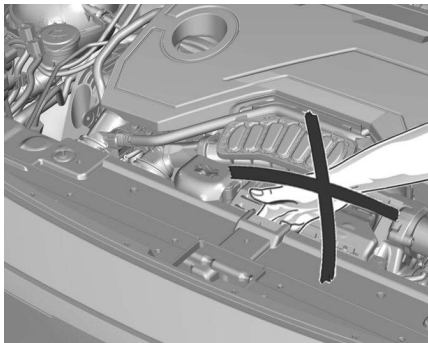

Warning

Only perform engine compartment checks when the ignition is off. The cooling fan may start operating even if the ignition is off.

BEV

Danger

The ignition system uses extremely high voltage. Do not touch.



Danger

Never try to perform maintenance work on high voltage components yourself. You may be injured and the vehicle may be damaged. Service and repair of these high voltage components should only be performed by a trained service technician with proper knowledge and tools. Exposure to high voltage may cause shock, burns, and even death. The high voltage components in the vehicle can only be serviced by technicians with special training. High voltage components are identified by labels. Do not remove, open, take apart, or modify these components. High voltage cable or wiring has orange covering. Do not probe, tamper with,

cut, or modify high voltage cable or wiring.

Caution

Even small amounts of contamination to the liquids can cause damage to vehicle systems. Do not allow contaminants to contact the fluids, reservoir caps, or dipsticks.

Bonnet

Opening

Open the left front door.

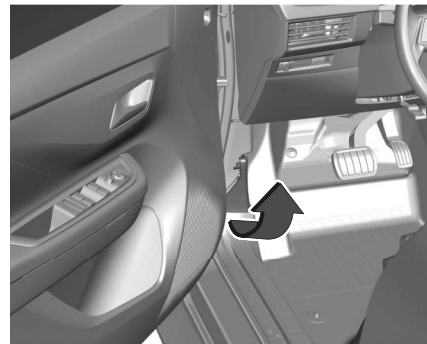

Pull the release lever and return it to its original position.

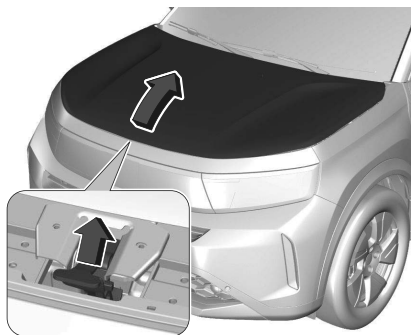

Lift the exterior safety catch and raise the bonnet.

Unclip the bonnet support from its housing and place it in the support slot to hold the bonnet open.

Closing

Hold the bonnet and pull out the bonnet support from the support slot.

Clip the bonnet support in its housing. Lower the bonnet and let it fall into the latch from a low height (20-25 cm).

Caution

Do not press the bonnet into the latch to avoid dents.

Check that the bonnet is engaged.

Caution

Because of the presence of electric equipment under the bonnet, it is strongly recommended that exposure to water (rain, washing, etc.) be limited.

Caution

Do not press the bonnet into the latch to avoid dents.

Engine Oil

Check the engine oil level manually on a regular basis to prevent damage to the engine. Ensure that the correct specification of engine oil is used.

Recommended fluids and lubricants ⇔ page 163

The maximum engine oil consumption is 0.6 l per 1000 km.

Check with the vehicle on a level surface. The engine must be at operating temperature and switched off for at least five minutes.

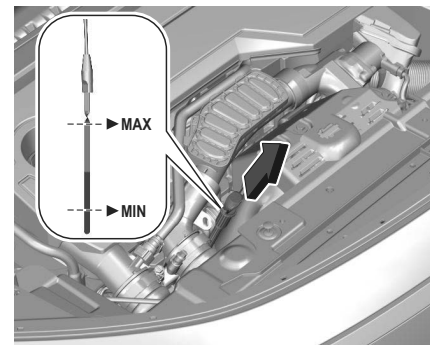

Pull out the dipstick, wipe it clean, reinsert it fully, pull out and read the engine oil level.

Different dipsticks are used depending on engine variant.

⚠ Warning

Insert dipstick fully up to the stop on the handle.

Ensure that no engine oil gets into the engine compartment, as this increases risk of fire.

When the engine oil level has dropped to the **MIN** mark, top up the engine oil. We recommend the use of the same grade of engine oil that was used at last oil change.

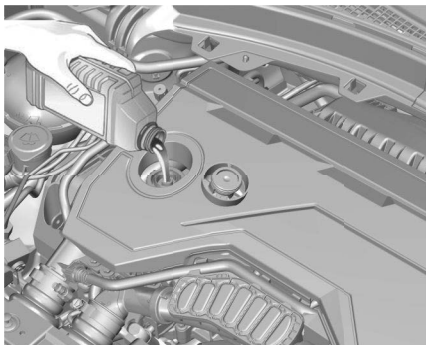

The engine oil level must not exceed the **MAX** mark on the dipstick.

Caution

Overfilled engine oil must be drained or suctioned out. If the engine oil exceeds the maximum level, do not start the vehicle and contact a workshop.

Fit the cap on straight and tighten it.
Capacities ⇒ page 169

Engine Coolant

The factory filled coolant provides freeze protection down to approx. -37 °C.

Caution

A too low coolant level can cause damage to the high voltage components.

Caution

Only use approved antifreeze.

Coolant and antifreeze ⇒ page 163

Coolant level BEV

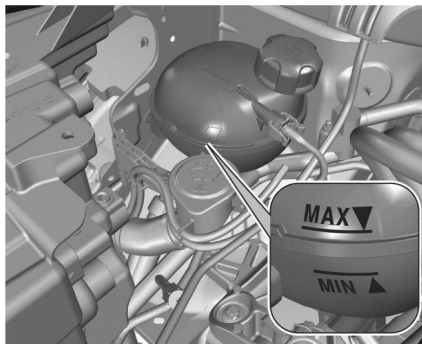

If the coolant level is at the MIN mark or below, seek the assistance of a workshop to have the engine coolant topped up.

Caution

Using the wrong engine coolant can cause severe damages to the high voltage battery. Only experienced mechanics are allowed to open the coolant reservoir and to top up coolant.

Propulsion types ⇒ page 3

Coolant level ICE and Hybrid 48 V

If the cooling system is cold, the coolant level should be above the MIN mark. Top up if the level is low.

⚠ Warning

Allow the engine to cool before opening the cap. Carefully open the cap, relieving the pressure slowly.

To top up, use a 1:1 mixture of released coolant concentrate mixed with clean tap water. If no coolant concentrate is available, use clean tap water. Install the cap tightly.

Have the coolant concentration checked and have the cause of the coolant loss remedied by a workshop.

Washer Fluid

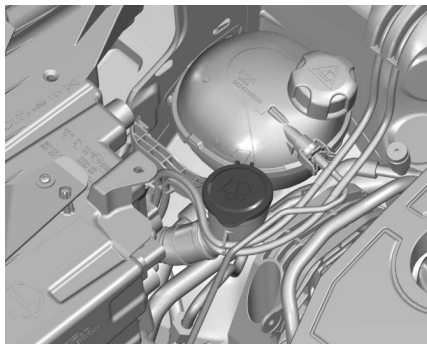

Fill with clean water mixed with a suitable quantity of approved windscreen washer fluid which contains antifreeze.

Caution

Only washer fluid with a sufficient antifreeze concentration provides protection at low temperatures or a sudden drop in temperature.

Washer fluid ⇒ page 163

Brakes

Depending on the driving style, the brake wear may vary significantly. The brake wear may increase when the vehicle is driven over short distances, e.g. in the city.

It may be necessary to have the condition of the brakes checked, even between vehicle services. Unless there is a leak in the circuit, a drop in the brake fluid level indicates that the brake pads are worn. Once new brake linings are installed, do not brake unnecessarily hard for the first few journeys.

Brake Fluid

⚠ Warning

Brake fluid is poisonous and corrosive. Avoid contact with eyes, skin, fabrics and painted surfaces.

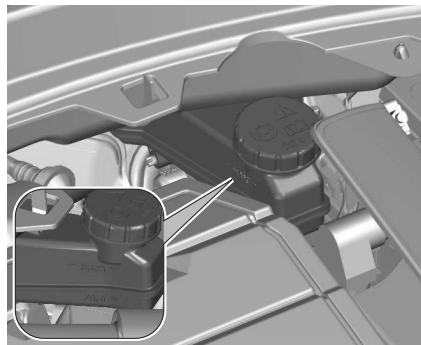

The brake fluid level must be between the **MIN** and **MAX** marks.

If fluid level is below **MIN** seek the assistance of a workshop.
Brake fluid ⇒ page 163

Vehicle Battery

The vehicle battery is maintenance-free provided that the driving profile allows sufficient charging of the battery. Short-distance-driving and frequent engine starts can discharge the battery. Avoid the use of unnecessary electric consumers.



Batteries do not belong in household waste. They must be disposed of at an appropriate recycling collection point. Laying up the vehicle for more than four weeks can lead to battery discharge. Disconnect the light from the negative terminal of the vehicle battery. Ensure the ignition is switched off before connecting or disconnecting the vehicle battery.
Battery discharge protection ⇒ page 82
Anti-theft alarm system ⇒ page 9

Warning label



Meaning of symbols:

- No sparks, naked flames or smoking.
- Always shield eyes. Explosive gases can cause blindness or injury.
- Keep the vehicle battery out of reach of children.
- The vehicle battery contains sulphuric acid which could cause blindness or serious burn injuries.
- See the Owner's Manual for further information.
- Explosive gas may be present in the vicinity of the vehicle battery.

Replacing the vehicle battery

Note

Any deviation from the instructions given in this section may lead to temporary

deactivation or disturbance of the stop-start system.

When the vehicle battery is being replaced, ensure that there are no open ventilation holes in the vicinity of the positive terminal. If a ventilation hole is open in this area, it must be closed off with a dummy cap, and the ventilation in the vicinity of the negative terminal must be opened.

Ensure that the vehicle battery is always replaced by the same type of battery.

All battery information

can be found online

at <https://public-servicebox.opel.com/OVddb/OV/index.html>

The vehicle battery has to be replaced by a workshop.

Stop-start system ⇒ page 91

Charging the vehicle battery

Warning

On vehicles with stop-start system, ensure that the charging potential does not exceed 14.6 V when using a battery charger.

Otherwise the vehicle battery may be damaged.

Jump starting ⇒ page 157

Discharge protection

Battery voltage

When the vehicle battery voltage is running low, a warning message will appear on the cluster.

When the vehicle is being driven, the load reduction function temporarily deactivates certain functions, e.g. the heated rear window, the heated steering wheel, etc.

The deactivated functions are reactivated automatically as soon as conditions permit.

Idle boost

If charging of the vehicle battery is required due to battery condition, the power output of the generator must be increased. This will be achieved by an idle boost which may be audible.

A message appears on the cluster.

Power outlet

The power outlets are deactivated in the event of low vehicle battery voltage.

Power saving mode

This mode deactivates electrical consumers to avoid excessive discharging of the vehicle battery.

These consumers, such as the Infotainment system, windscreen wipers,

low beam headlights, courtesy light, etc. can be used for a total maximum time of about 40 minutes after ignition is switched off.

Changing into power saving mode

When power saving mode is activated, a message appears on the cluster, when the ignition has been switched off. An active telephone call using the hands-free option will be maintained for around ten minutes longer.

Deactivating power saving mode

Power saving mode is deactivated automatically when the engine is restarted. Run the engine for a sufficient charge:

- for less than ten minutes to use the consumers for approx. 5 minutes
- for more than ten minutes to use the consumers for up to approx. 30 minutes

Heating functionalities

Note

Individual heating functionalities, such as heated seats or heated steering wheel, may be temporarily unavailable in the event of electric loading constraints. Functions will be resumed after some minutes.

Wiper Blade Replacement

Windscreen

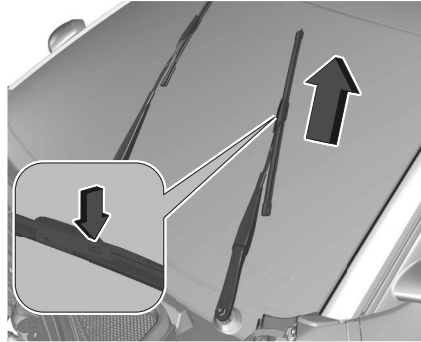

Switch off ignition.

Within one minute after switching off ignition, operate the wiper lever to position the wiper blades vertically on the windscreen.

Lift the wiper arm until it stays in the raised position, press button to disengage the wiper blade and remove. Attach the new wiper blade to the wiper arm and push until it engages. Lower wiper arm carefully.

Rear window

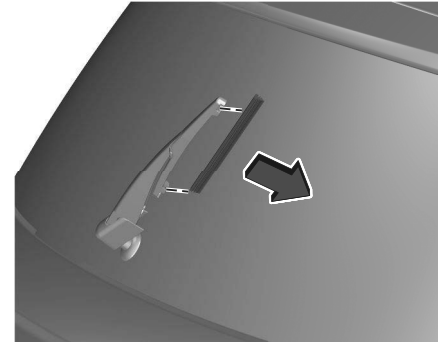

Lift wiper arm. Disengage wiper blade as shown in illustration and remove. Attach the wiper blade slightly angled to the wiper arm and push until it engages. Lower wiper arm carefully.

Bulb Replacement

Before replacing a bulb, ensure that all exterior and interior lights and the ignition are switched off.

Only hold a new bulb at the base. Do not touch the bulb glass with bare hands. Use only the same bulb type for replacement.

Bulb check

Switch on the ignition, operate and check the lights.

Light-Emitting Diode (LED) Headlights And Lights

Headlights for low and high beam, daytime running lights and turn lights are designed as LEDs and cannot be changed.

Have lights repaired by a workshop in case of failure.

Front Fog Lights

Fog lights are designed as LEDs.

Have the lights repaired by a workshop in case of failure.

Rear Fog Lights

Fog lights are designed as LEDs.

Have the lights repaired by a workshop in case of failure.

Tail Lights

LED Tail Lights

Have lights repaired by a workshop in case of failure.

Tail Light Assembly

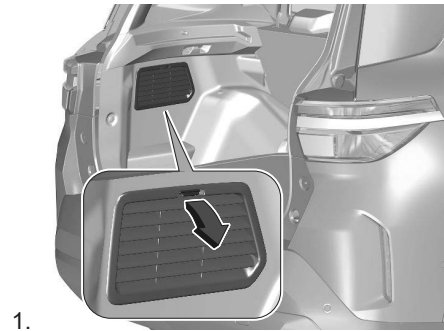

1.

Open the tailgate then unclip the access cover on the relevant side.

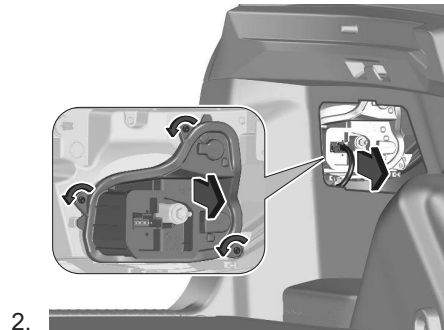

2.

Carefully detach the plug from the retainer.

Turn the three screws anticlockwise and take them out. Remove the bulb carrier from the tail light assembly.

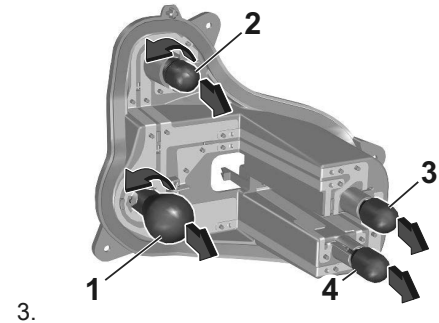

3.

Remove and replace the bulbs:

- 1 Position light / Stop light
- 2 Position light
- 3 Turn light
- 4 Reverse light

4. Insert the bulb carrier into the tail light assembly.

Insert the three screws and turn them clockwise. Attach the plug to the light assembly. Attach the cover.

Centre High-Mounted Brake Light

Have lights repaired by a workshop in case of failure.

Number Plate Light



- Insert a screwdriver in the recess of the cover and remove it.
- Pull the bulb from the bulb holder and replace it.
- Attach the cover.

Interior Lights

Have the following bulbs replaced by a workshop:

- courtesy light, reading lights
- load compartment light

- instrument cluster illumination

Electric System

Fuses

A defective fuse must be replaced by a workshop.

Vehicle Tools

Depending on version the vehicle tools are located in a toolbag in the load compartment either behind the third row or below the floor cover.

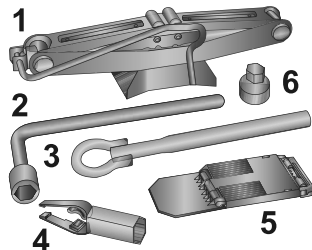

- 1 Jack
- 2 Wheel wrench

- 3 Towing eye
- 4 Wheel bolt cover remover
- 5 Chock
- 6 Adapter for the locking wheel nuts

Depending on version, the chock, the towing eye and the adapter for the locking wheel nuts may be located in a bag together with the tire repair kit. ⇨ page 150

For vehicles with spare wheel the jack and wheel wrench is located in a toolbox inside the spare wheel. ⇨ page 154

Wheels And Tires

Tire condition, wheel condition

Drive over edges slowly and at right angles if possible. Driving over sharp edges can cause tire and wheel damage. Do not trap tires on the kerb when parking.

Regularly check the wheels for damage. Seek the assistance of a workshop in the event of damage or unusual wear.

Winter Tires

Winter tires improve driving safety at temperatures below 7 °C and should therefore be fitted on all wheels.

In accordance with country-specific regulations, affix the speed sticker in the driver's field of view, if the tire speed code is below the maximum speed of the vehicle.

All tire sizes are permitted as winter tires
⇒ page 170

Tire Designations

E.g. **215/60 R17 96H**

215 : tire width, mm

60 : cross-section ratio (tire height to tire width), %

R : belt type: Radial

RF : type: RunFlat

15 : wheel diameter, inches

91 : load index e.g. 95 is equivalent to 615 kg

T : speed code letter

Speed code letter:

Q : up to 160 km/h

S : up to 180 km/h

T : up to 190 km/h

H : up to 210 km/h

V : up to 240 km/h

W : up to 270 km/h

Choose a tire appropriate for the maximum speed of the vehicle. The maximum speed is achievable at kerb weight with driver (75 kg) plus 125 kg payload. Optional equipment could reduce the maximum speed of the vehicle.

Directional tires

Directional tires should be mounted so that they rotate in the correct direction. The proper rotation direction is indicated by a symbol (e.g. an arrow) on the sidewall.

Tire Pressure

Check the pressure of cold tires at least every 14 days and before any long journey.

Do not forget the spare wheel.

⇒ page 170

This also applies to vehicles with tire deflation detection system.

⇒ page 133



The tire pressure information label on the left or right door frame indicates the original equipment tires and the correspondent tire pressures. The tire pressure data refers to cold tires. It applies to summer and winter tires. Always inflate the spare tire to the pressure specified for full load. Incorrect tire pressures will impair safety, vehicle handling, comfort and fuel economy and will increase tire wear. Tire pressures differ depending on various options. For the correct tire pressure value, follow the procedure below:

1. Identify the respective tire.
2. Identify the engine identifier code.

⇒ page 167

The tire pressure tables show all possible tire combinations.

⇒ page 170

For the tires approved for your vehicle, refer to the Certificate of Conformity provided with your vehicle or other national registration documents.

The driver is responsible for correct adjustment of tire pressure.

Warning

If the pressure is too low, this can result in considerable tire warmup and internal damage, leading to tread separation and even to tire blow-out at high speeds.

Warning

For specific tyres the recommended tyre pressure as shown in the tyre pressure table may exceed the maximum tyre pressure as indicated on the tyre.

Never exceed the maximum tyre pressure as indicated on the tyre.

Temperature dependency

The tire pressure depends on the temperature of the tire. During driving, tire temperature and pressure increase. Tire pressure values provided on the tire

information label and tire pressure chart are valid for cold tires, which means at 20 °C.

The pressure increases by nearly 10 kPa for a 10 °C temperature increase. This must be considered when warm tires are checked.

Tread Depth

Check tread depth at regular intervals. For safety reasons, it is recommended that the tread depth of the tires on one axle should not vary by more than 2 mm.



The legally permissible minimum tread depth (1.6 mm) has been reached when the tread has worn down as far as one of the tread wear indicators (TWI). Their position is indicated by markings on the sidewall.

If there is more wear at the front than the rear, swap round front wheels and rear wheels periodically. If directional tires are mounted, ensure that the direction of rotation of the wheels remains the same. Tires age, even if they are not used. We recommend tire replacement every 6 years.

Changing Tire And Wheel Size

If tires of a different size than those fitted at the factory are used, it may be necessary to reprogramme systems and make other vehicle modifications. Have the label with tire pressures replaced.

Warning

The use of unsuitable tires or wheels may lead to accidents and will invalidate the vehicle operating permit.

Wheel Covers

Wheel covers and tires that are factory approved for the respective vehicle and comply with all of the relevant wheel and tire combination requirements must be used.

If the wheel covers and tires used are not factory approved, the tires must not have a rim protection ridge.

Wheel covers must not impair brake cooling.

Warning

Use of unsuitable tires or wheel covers could lead to sudden pressure loss and thereby accidents.

Vehicles with steel wheel rims: When using locking wheel nuts, do not attach wheel covers.

Temporary spare wheel: Do not use wheel covers

Tire Chains

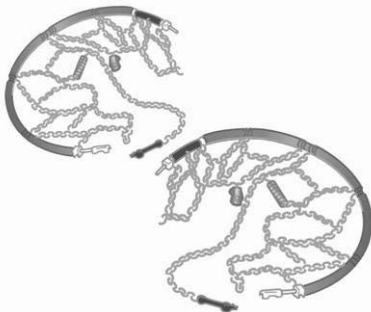

Tire chains are only permitted on the front wheels.

Only use tire chains designed to be used with tire type of the vehicle:

- For 16 inch and 17 inch tires, only use fine mesh tire chains that add no more than 9 mm to the tire tread and the inboard sides (including chain lock).
- For 18 inch tires, only use Polaire PSGB 60 tire chains.

Note

The use of tire chains and the maximum allowed speed is regulated by country-specific legislation.

When fitting the tire chains follow the instructions provided by the manufacturer of the tire chains.

After having fitted the tire chains, stop the vehicle after having driven a short distance and make sure that the tire chains are correctly tightened.

Warning

Damage may lead to tire blowout.

Temporary spare wheel

The use of tire chains is not permitted on the temporary spare wheel.

Tire Repair Kit

Minor damage to the tire tread can be repaired with the tire repair kit.

Do not remove foreign bodies from the tires.

Tire damage exceeding 4 mm or that is at tire's sidewall cannot be repaired with the tire repair kit.

Warning

Do not drive faster than 80 km/h.
Do not use for a lengthy period.
Steering and handling may be affected.

In the case of a flat tire:

Apply the parking brake and engage first gear, reverse gear or **P**.

Depending on version the location of the tire repair kit is different:

- at the left side of the load compartment
- below the third row seats with the seats folded
- behind the third row seat with the seats unfolded.

1. Remove the sealant bottle and the compressor.

2. Pull the speed limit label from the sealant bottle and place it in driver's visible area.

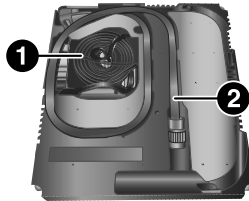

3. Remove the electric connection cable (1) and air hose (2) from the stowage compartments on the underside of the compressor.

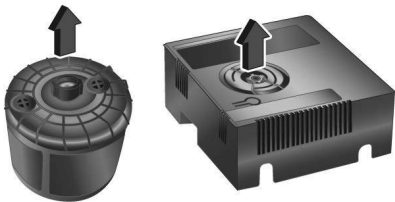

4. Open the sealant bottle and lift the lid.

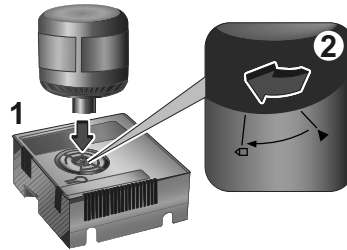

5. First, insert the sealant bottle into the compressor and align the triangle symbols. Then, push down the sealant bottle and turn it to the lock position.
6. Set the compressor near the tire in such a way that the sealant bottle is upright.
7. Unscrew the valve cap from the defective tire.

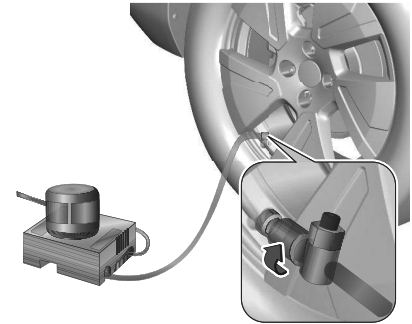

8. Screw the filler hose to the tire valve.
9. The switch on the compressor must be set to O.

10. Connect the compressor plug to the 12 V power outlet.
To avoid discharging the vehicle battery, we recommend to use the tire repair kit only when the combustion engine is running or when the electric engine is ready.

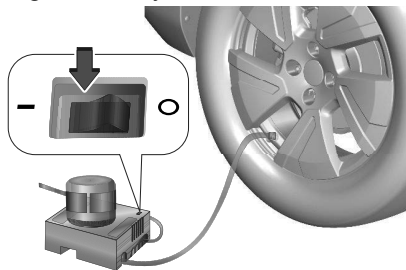

11. Set the rocker switch on the compressor to I. The tire is filled with sealant.
12. The compressor pressure gauge briefly indicates up to 600 kPa (6 bar) whilst the sealant bottle is emptying (approx. 30 seconds). Then the pressure starts to drop.
13. All of the sealant is pumped into the tire. Then the tire is being inflated.
14. The prescribed tire pressure should be obtained within ten minutes.

Tire pressure ⇒ page 170
When the correct pressure is obtained, switch off the compressor. If the prescribed tire pressure is not obtained within ten minutes, remove the tire repair kit. Move the vehicle one tire rotation.
Reattach the tire repair kit and continue the filling procedure for ten minutes. If the prescribed tire pressure is still not obtained, the tire is too badly damaged. Seek the assistance of a workshop.

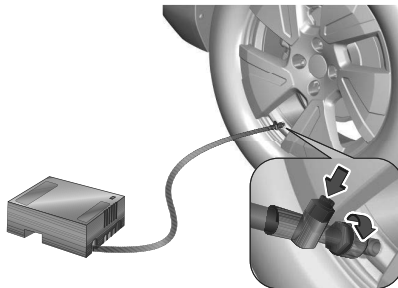

- Drain excess tire pressure with the button on the air hose.
Do not run the compressor longer than ten minutes.
15. Detach the tire repair kit. Remove the sealant bottle from the compressor.

Screw the filler hose to the free connection of the sealant bottle. This prevents the sealant from escaping. Stow the tire repair kit in its designated position.

16. Remove any excess sealant using a cloth.
17. Continue driving immediately so that sealant is evenly distributed in the tire. Drive between 20 km/h and 60 km/h. After driving approx. 5 km but no more than ten minutes, stop and check tire pressure. Screw compressor air hose directly onto tire valve when doing this. Fill tire as described before. Drain excess tire pressure with the button on the air hose.
If tire pressure hasn't decreased under 200 kPa (2 bar), set it to the correct value. Otherwise the vehicle must not be used. Seek assistance of a workshop.
Repeat the checking procedure once more after driving further 10 km but no more than ten minutes to check that there is no more loss of pressure. If the tire pressure has fallen below 200 kPa (2 bar), the vehicle must not be used. Seek the assistance of a workshop.

18. Stow the tire repair kit in its designated position.

Note

The driving characteristics of the repaired tire are severely affected, therefore have this tire replaced.

If unusual noise is heard or the compressor becomes hot, turn the compressor off for at least 30 min.

The built-in safety valve opens at a pressure of 700 kPa (7 bar).

Note the expiry date of the kit. After this date its sealing capability is no longer guaranteed. Pay attention to the storage information on the sealant bottle.

Replace the used sealant bottle.

Dispose of the bottle as prescribed by applicable laws.

The compressor and sealant can be used from approx. -30 °C.

Wheel Changing

Make the following preparations and observe the following information:

- Park the vehicle on a level, firm and non-skid surface. The front wheels must be in the straightahead position.
- Apply the parking brake and engage first gear, reverse gear or **P**.

- Place a chock under the wheel diagonally opposite the wheel to be changed.
- If the ground on which the vehicle is standing is soft, a solid board (max. 1 cm thick) should be placed under the jack.
- Take heavy objects out of the vehicle before jacking up.
- No people or animals may be in the vehicle when it is jacked-up.
- Never crawl under a jacked-up vehicle.
- Do not start the vehicle when it is raised on the jack.
- Before screwing in the wheel bolts, clean them.

⚠ Warning

Do not grease wheel bolts.

Tightening torques

⚠ Warning

Ensure to use always the correct wheel bolts if changing the wheels. When installing the spare wheel for temporary usage, the bolts for alloy wheel rims can also be used.

Depending on the wheel rim material, two different bolts are available.



Tightening torque for alloy wheel rims is 115 Nm.



Tightening torque for steel wheel rims is 125 Nm.

Use the correct wheel bolts for the respective wheel rims.

Jacking positions

The jacking positions shown refer to the use of lifting arms and accessory jacks used for changing winter / summer tires.



The rear arm position of the lifting platform is centrally under the relevant vehicle jacking point.

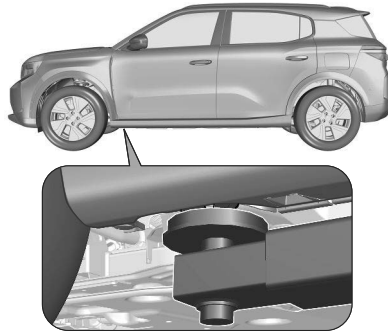

The front arm position of the lifting platform is centrally under the relevant vehicle jacking point.

Spare Wheel

The spare wheel can be classified as a temporary spare wheel depending on the size compared to the other mounted wheels and country regulations. In this case a permissible maximum speed applies, even though no label at the spare wheel indicates this.

If there is a label on the spare wheel, the permissible speed still depends on the country regulations.

Only mount one temporary spare wheel. Take curves slowly. Do not use for a long period of time.

Caution

The use of a spare wheel that is smaller than the other wheels or in combination with winter tires could affect driveability. Have the defective tire replaced as soon as possible.

Depending on version the spare wheel is located in the load compartment beneath the floor covering or in a holder beneath the vehicle floor.

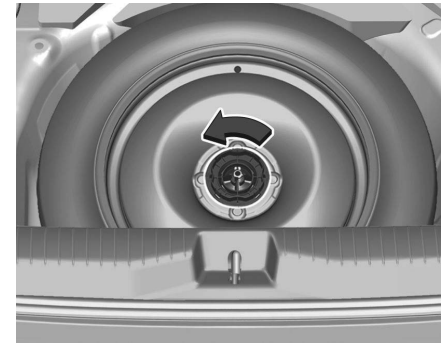

To remove:

1. Open the floor cover.
2. Unclip the toolbox
Vehicle tools ⇨ page 147

3. The spare wheel is secured with a wing nut. Unscrew nut and take out the spare wheel.
4. If, after a wheel change, no wheel is placed in the spare wheel well, fasten the wing nut and close the floor cover.
5. After a wheel change back to a full size wheel, place the spare wheel outside up in the well and secure with the wing nut.

Fitting the spare wheel

Make the following preparations and observe the following information:

- Park the vehicle on a level, firm and non-skid surface. The front wheels must be in the straight-ahead position.
- Apply the parking brake and engage first gear, reverse gear or **P**.
- Place a chock under the wheel diagonally opposite the wheel to be changed.
- Remove the spare wheel.
- Never change more than one wheel at once.
- Use the jack only to change wheels in case of puncture, not for seasonal winter or summer tire change.
- The jack is maintenance-free.

- If the ground on which the vehicle is standing is soft, a solid board (max. 1 cm thick) should be placed under the jack.
- Take heavy objects out of the vehicle before jacking up.
- No people or animals may be in the vehicle when it is jacked-up.
- Never crawl under a jacked-up vehicle.
- Do not start the vehicle when it is raised on the jack.
- Before screwing in the wheel bolts, clean them.

Warning

Do not grease wheel bolts.

Warning

Ensure to use always the correct wheel bolts if changing the wheels. When installing the spare wheel for temporary usage, the bolts for alloy wheel rims can also be used.

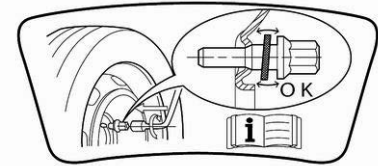

Note that the spare wheel is secured by the conical contact of each bolt if the wheel bolts for the alloy wheel rims are used. In this case, the washers do not come into contact with the spare wheel.

1. Disengage wheel bolt caps with the wheel bolt cover remover.
Vehicle tools ⇒ page 147
Steel wheel rims with cover: Pull off the wheel cover.



2. Attach the wheel wrench and loosen each wheel bolt by half a turn.
The wheels might be protected by locking wheel bolts. To loosen these specific bolts, first attach the adapter for the locking wheel bolts onto the head of the bolt before installing the wheel wrench.
The adapter for the locking wheel nuts may be located in a toolbag in the load compartment or in a bag together with the tire repair kit.
Vehicle tools ⇒ page 147
Tire repair kit ⇒ page 150

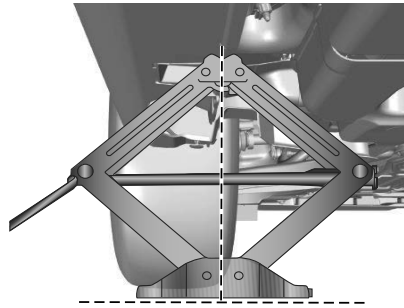

3. Ensure the jack is correctly positioned under the relevant vehicle jacking point.
Jacking positions ⇒ page 154
4. Set the jack to the necessary height.
Position it directly below the jacking point in a manner that prevents it from slipping.

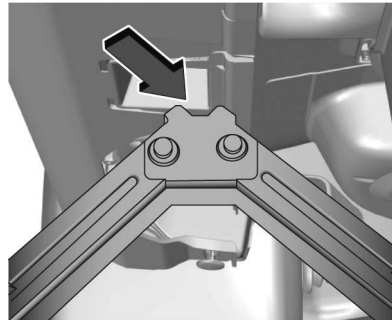

5. Ensure that the edge of the body fits into the notch of the jack.
6. With the jack correctly aligned, jack up until wheel is clear of the ground.
7. Unscrew the wheel nuts.
8. Change the wheel.
9. Screw on the wheel nuts.
10. Lower the vehicle and remove jack.
11. Install the wheel wrench ensuring that it is located securely and tighten each bolt in a crosswise sequence.
Tightening torque is 100 Nm.

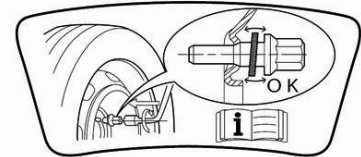

12. If the vehicle is equipped with alloy wheel rims, note that the wheel bolts can also be used for the spare wheel. In this case, the spare wheel is secured by the conical contact of each bolt.

13. Install wheel nut caps.
14. Stow and secure the replaced wheel and the tools.
15. Check the tire pressure of the installed tire and the tightening torque as soon as possible.

Stowing a damaged full size wheel in the load compartment

The spare wheel well is not designed for other tire sizes than the spare wheel. A damaged full size wheel must be stowed in the load compartment and secured properly.

Loading information ⇒ page 39

Jump Starting

Caution

Only jump start another vehicle with an ICE vehicle.

Do not start with quick charger. A vehicle with a discharged vehicle battery can be started using jump leads and the vehicle battery of another vehicle.

⚠ Warning

Be extremely careful when starting with jump leads. Any deviation from the following instructions can lead to injuries or damage caused by battery explosion or damage to the electrical systems of both vehicles.

⚠ Warning

Avoid contact of the battery with eyes, skin, fabrics and painted surfaces. The fluid contains sulphuric acid which can cause injuries and damage in the event of direct contact.

- Never expose the vehicle battery to naked flames or sparks.
- A discharged vehicle battery can already freeze at a temperature of 0 °C. Defrost the frozen battery before connecting jump leads.
- Wear eye protection and protective clothing when handling a battery.
- Use a booster battery with the same voltage (12 V). Its capacity (Ah) must not be much less than that of the discharged vehicle battery.

- Use jump leads with insulated terminals and a cross section of at least 16 mm².
- Do not disconnect the discharged vehicle battery from the vehicle.
- Switch off all unnecessary electric consumers.
- Do not lean over the vehicle battery during jump starting.
- Do not allow the terminals of one lead to touch those of the other lead.
- The vehicles must not come into contact with each other during the jump starting process.
- Apply the parking brake, automatic transmission in P.

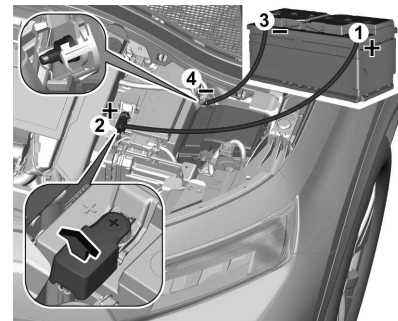

Open the positive terminal protection caps of both vehicle batteries.

Lead connection order:

1. Connect the red lead to the positive terminal of the booster battery (1).
2. Connect the other end of the red lead to the positive terminal of the discharged battery (2).
3. Connect the black lead to the negative terminal of the booster battery (3).
4. Connect the other end of the black lead to a vehicle grounding point of your vehicle in the engine compartment (4).

Route the leads so that they cannot catch on rotating parts in the engine compartment.

To start the engine:

1. Start the engine of the vehicle providing the jump.
2. After five minutes, start the other engine. Start attempts should be made for no longer than 15 seconds at an interval of one minute.
3. Allow both engines to idle for approx. three minutes with the leads connected.

4. Switch on electric consumers e.g. headlights, heated rear window.
5. Reverse above sequence exactly when removing leads.

Towing

Towing The Vehicle

Front cap

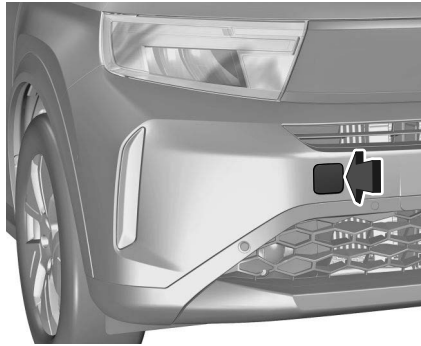

Remove the cap.
The towing eye is stowed with the vehicle tools ⇒ page 147

Front towing eye

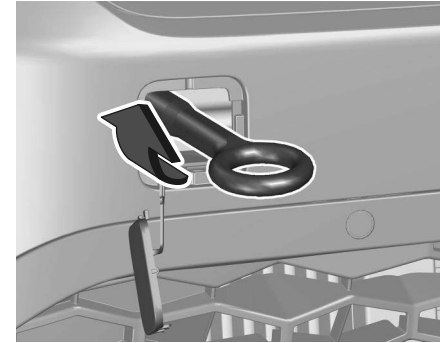

Screw in the towing eye as far as it will go until it stops in a horizontal position. Attach the tow rod to the towing eye. The towing eye must only be used for towing and not for recovering the vehicle. Switch on ignition to release steering wheel lock and to permit operation of brake lights, horn and windscreen wiper.

Caution

Deactivate the driver assistance systems like active emergency braking, otherwise the vehicle may automatically brake during towing.

Switch the selector lever to neutral.
Release the parking brake.

Caution

Drive slowly.
Do not drive jerkily.

When the engine is not running, considerably more force is needed to brake and steer.
To prevent the entry of exhaust gases from the towing vehicle, switch on the air recirculation and close the windows.

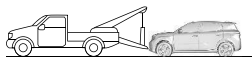
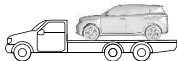

When towing a BEV, a Hybrid 48 V vehicle or a vehicle equipped with an automatic transmission, transport the vehicle on a platform or tow it with the front wheels lifted.

Seek the assistance of a workshop.
After towing, unscrew the towing eye.

Insert cap with the outer flange into the recess and fix cap by pushing.

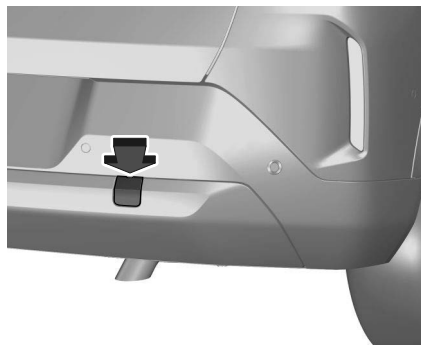
Towing Another Vehicle**Rear cap**

Remove the cap.
The towing eye is stowed with the vehicle tools ⇒ page 147

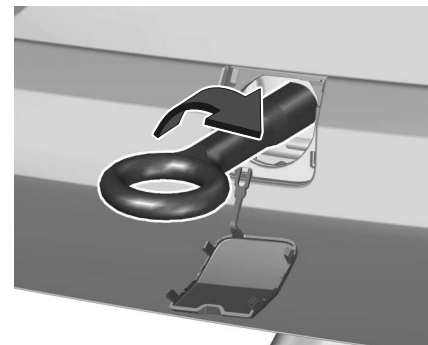
Rear towing eye

Screw in the towing eye as far as it will go until it stops in a horizontal position. Attach a tow rope – or better still a tow rod – to the towing eye.
The towing eye must only be used for towing and not for recovering a vehicle.

Caution

Drive slowly.
Do not drive jerkily.

After towing, unscrew the towing eye.
Insert cap with the upper flange into the recess and fix cap by pushing.

| |
|---|
| Caution |
| For Hybrid (MHEV) (>2500 m asl) towing capacity is restricted as it may affect vehicle performance. |

Appearance Care

Exterior Care

Locks

The locks are lubricated at the factory using a high quality lock cylinder grease. Use a de-icing agent only when absolutely necessary, as this has a degreasing effect and impairs lock function. After using a de-icing agent, have the locks regreased by a workshop.

Washing

The paintwork is exposed to environmental influences. Bird droppings, dead insects, resin, pollen and the like should be cleaned off immediately, as they contain aggressive constituents which can cause paint damage. If using a vehicle wash, comply with the vehicle wash manufacturer's instructions. The windscreen wiper and rear window wiper must be switched off. Remove

antenna and external accessories such as roof racks etc.

If the vehicle is washed by hand, make sure that the insides of the wheel housings are also thoroughly rinsed out. Clean edges and folds on opened doors and the bonnet as well as the areas they cover.

Clean bright metal mouldings with a cleaning solution approved for aluminium to avoid damages.

| |
|--|
| Caution |
| Always use a cleaning agent with a pH value of four to nine. Do not use cleaning agents on hot surfaces. |

Do not clean the engine compartment with a steam-jet or high-pressure jet cleaner.

Thoroughly rinse and leather-off the vehicle. Rinse leather frequently. Use separate leathers for painted and glass surfaces: remnants of wax on the windows will impair vision.

Have the door hinges of all doors greased by a workshop.

Do not use hard objects to remove spots of tar. Use tar removal spray on painted surfaces.

Exterior lights

Headlight and other light covers are made of plastic. Do not use any abrasive or caustic agents, do not use an ice scraper, and do not clean them dry.

Polishing and waxing

Polishing is necessary only if the paint has become dull or if solid deposits have become attached to it.

Plastic body parts must not be treated with wax or polishing agents.

Windows and windscreen wiper blades

Switch off wipers before handling in their areas.

Use a soft lint-free cloth or chamois leather together with window cleaner and insect remover.

When cleaning the rear window from inside, always wipe in parallel to the heating element to prevent damage. For mechanical removal of ice, use a sharp-edged ice scraper. Press the scraper firmly against the glass so that no dirt can get under it and scratch the glass.

Clean smearing wiper blades with a soft cloth and window cleaner. Also make sure to remove any residues such as wax, insect residues and similar from the window.

Ice residues, pollution and continuous wiping on dry windows will damage or even destroy the wiper blades.

Wheels and tires

Do not use high-pressure jet cleaners. Clean rims with a pH-neutral wheel cleaner.

Rims are painted and can be treated with the same agents as the body.

Paintwork damage

Rectify minor paintwork damage with a touch-up pen before rust forms.

Have more extensive damage or rust areas repaired by a workshop.

Underbody

Some areas of the vehicle underbody have a PVC undercoating while other critical areas have a durable protective wax coating.

After the underbody is washed, check the underbody and have it waxed if necessary.

Bitumen / rubber materials could damage the PVC coating. Have underbody work carried out by a workshop.

Before and after winter, wash the underbody and have the protective wax coating checked.

Towing equipment

Do not clean the coupling ball bar with a steam-jet or high-pressure jet cleaner.

Interior Care

Interior and upholstery

Only clean the vehicle interior, including the instrument panel fascia and panelling, with a dry cloth or interior cleaner.

Clean the leather upholstery with clear water and a soft cloth. In case of heavy soiling, use leather care.

The instrument cluster and the displays should only be cleaned using a soft damp cloth. If necessary use a weak soap solution.

Clean fabric upholstery with a vacuum cleaner and brush. Remove stains with an upholstery cleaner.

Clothing fabrics may not be colourfast. This could cause visible discolourations, especially on lightcoloured upholstery. Removable stains and discolourations should be cleaned as soon as possible. Clean seat belts with lukewarm water or interior cleaner.

Caution

Close Velcro fasteners as open Velcro fasteners on clothing could damage seat upholstery.

The same applies to clothing with sharp-edged objects, like zips or belts or studded jeans.

Plastic and rubber parts

Plastic and rubber parts can be cleaned with the same cleaner as used to clean the body. Use interior cleaner if necessary. Do not use any other agent. Avoid solvents and petrol in particular. Do not use highpressure jet cleaners.

Floor Mats

Warning

If a floor mat has the wrong size or is not properly installed, it can interfere with pedals, what can cause unintended acceleration or increased stopping distance which can cause a crash and injury.

Use the following guidelines for proper floor mat usage.

- The original equipment floor mats were designed for this vehicle. If the floor mats need to be replaced, it is recommended to buy certified floor mats which fit properly and are fixed by the retainers on the driver side. Always check that the floor mats do not interfere with the pedals.

- Use the floor mat with the correct side up. Do not turn it over.
- Do not place anything on top of the driver's side floor mat.
- Use only a single floor mat on the driver's side.

Installing and removing the floor mats

The driver's side floor mat is held in place by two retainers.

To install the floor mat:

1. Move the seat backwards as far as possible.

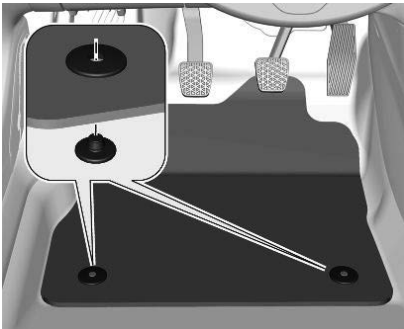

2. Align slots in the mat with the retainers, as shown.
3. Push the mat to the floor.

To remove the floor mat:

1. Move the seat backwards as far as possible.
2. Pull the floor mat upwards to remove.

Warning

To avoid any risk of jamming the pedals:

- Only use mats which are suited to the fixings already present in the vehicle; these fixings must be used.
- Never fit one mat on top of another.

The use of mats not approved by the Manufacturer may interfere with access to the pedals and hinder the operation of the cruise control/speed limiter. The approved mats have two fasteners located underneath the seat.

Service And Maintenance

| | |
|--|-----|
| General Information..... | 163 |
| Service Information..... | 163 |
| Recommended Fluids, Lubricants And Parts..... | 163 |

General Information

Service Information

In order to ensure economical and safe vehicle operation and to maintain the value of your vehicle, it is of vital importance that all maintenance work is carried out at the proper intervals as specified.

The detailed, up-to-date service schedule for your vehicle is available at the workshop.

Severe operating conditions exist if one or more of the following circumstances occur frequently: Cold starting, stop and go operation, e.g.

for taxis and police vehicles, trailer operation, mountain driving, driving on poor and sandy road surfaces, increased air pollution, presence of airborne sand and high dust content, driving at high altitude and large variations of temperature.

Under these severe operating conditions, certain service work may be required more frequently than the regular service interval indicated in the service display. Contact a workshop for customised service schedules.

Service display ⇨

Recommended Fluids, Lubricants And Parts

Only use products that meet the recommended specifications.

Warning

Operating materials are hazardous and could be poisonous. Handle with care. Pay attention to information given on the containers.

Engine oil

Engine oil is identified by its quality and its viscosity. Quality is more important than viscosity when selecting which engine oil to use. The engine oil quality ensures e.g. engine cleanliness, wear protection and engine oil aging control, whereas viscosity grade gives information on the engine oil's thickness over a temperature range.

Use the appropriate engine oil given on the service schedule sheet handed over by the selling dealer.

Recommended fluids and lubricants ⇨ page 163

Topping up engine oil

Tip

In case of any spilled engine oil, wipe it up and dispose of it properly.

Engine oils of different manufacturers and brands can be mixed as long as they comply with the required engine oil quality and viscosity.

Use of engine oils for all petrol engines with only ACEA quality is prohibited, since it can cause engine damage under certain operating conditions.

Recommended fluids and lubricants ⇒
page 163

Additional engine oil additives

The use of additional engine oil additives could cause damage and invalidate the warranty.

Engine oil viscosity grades

The SAE viscosity grade gives information of the thickness of the engine oil.

Multigrade engine oil is indicated by two figures, e.g. SAE 5W-30. The first figure, followed by a W, indicates the low temperature viscosity and the second figure the high temperature viscosity. Select the appropriate viscosity grade depending on the minimum ambient temperature.

Recommended fluids and lubricants ⇒
page 163

All of the recommended viscosity grades are suitable for high ambient temperatures.

Coolant and antifreeze

Use only antifreeze approved for the vehicle. Consult a workshop.

The system is factory filled with coolant designed for excellent corrosion protection and frost protection down to approx. -28°C. In cold regions with very low temperatures the factory filled coolant provides frost protection down to approx. -37°C.

This concentration should be maintained all year round. The use of additional coolant additives that intend to give additional corrosion protection or seal against minor leaks can cause function problems. Liability for consequences resulting from the use of additional coolant additives will be rejected.

Washer fluid

Use only washer fluid approved for the vehicle to prevent damage of wiper blades, paintwork, plastic and rubber parts. Consult a workshop.

Brake and clutch fluid

Over time, brake fluid absorbs moisture which will reduce braking effectiveness. The brake fluid should therefore be replaced at the specified interval. Use only brake fluid approved for the vehicle. Consult a workshop.

Technical Data

Vehicle Identification..... 165
 Vehicle Identification Number..... 165
 Identification Plate..... 165
 Engine Identification..... 166
 Engine Data..... 167
 Vehicle Dimensions..... 168
 Capacities..... 169
 Tire Pressures..... 170

Vehicle Identification

Vehicle Identification Number

The vehicle identification number may be embossed on the instrument panel, visible through the windscreen, or in the engine compartment on the right body panel.

Identification Plate



The identification plate is located on the front left or right door frame. The layout and position differ for some export countries.

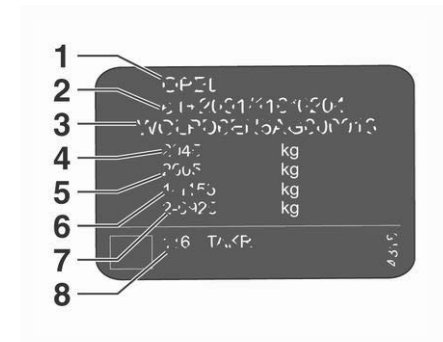

Information on identification label:

- 1 manufacturer
- 2 type approval number
- 3 vehicle identification number
- 4 permissible gross vehicle weight rating in kg
- 5 permissible gross train weight in kg
- 6 maximum permissible front axle load in kg
- 7 maximum permissible rear axle load in kg
- 8 manufacturer address, vehiclespecific or country-specific data

The combined total of front and rear axle loads must not exceed the permissible gross vehicle weight.

Vehicle's kerb weight depends on the specification of the vehicle, e.g. optional equipment and accessories.

Refer to the Certificate of Conformity provided with your vehicle or other national registration documents.

The technical data is determined in accordance with European Community standards. We reserve the right to make modifications.

Specifications in the vehicle documents always have priority over those given in this manual.

Engine Identification

The technical data tables use the engine identifier code. The engine data table additionally shows the engineering code.

Engine data ⇒ page 167

To identify the respective engine, refer to the EEC Certificate of Conformity provided with this vehicle or other national registration documents.

The Certificate of Conformity shows the engine identifier code, other national publications may show the engineering code. Check piston displacement and engine power to identify the respective engine.

Engine Data

| Engine identifier code | EB2LTED | EB2LTEDH2 | EB2LTDH2 | ELECTRIC VEHICLE |
|--|---------|-------------|-------------|---------------------|
| | ICE | Hybrid 48 V | Hybrid 48 V | BEV |
| Piston displacement [cm ³] | 1199 | 1199 | 1199 | - |
| Engine power [kW] | 74 | 74 | 100 | 83 |
| at rpm | 5500 | 5500 | 5500 | - |
| Torque [Nm] | 205 | 205 | 230 | 124.5 |
| at rpm | 1750 | 1750 | 1750 | - |
| Fuel type | Petrol | Petrol | Petrol | - |
| Octane rating RON ¹⁾²⁾ | | | | |
| recommended | 95 | 95 | 95 | - |
| possible | 98 | 98 | 98 | - |
| possible | 91 | 91 | 91 | - |
| Additional fuel type | - | - | - | - |

1) A country-specific label at the fuel filler flap can supersede the engine-specific requirement.

2) In certain countries, the use of a particular fuel, e.g. a specific octane rating, may be required to ensure proper engine operation.

Vehicle Dimensions

| Size | BEV | ICE/MHEV (5 seater) | ICE/MHEV (7 seater) |
|--|-----------|---------------------|-------------------------------------|
| Length [mm] | 4380-4389 | 4380-4389 | 4380-4389 |
| Width with two exterior mirrors folded [mm] | 1840-1849 | 1840-1849 | 1840-1849 |
| Width with two exterior mirrors [mm] | 2017-2020 | 2017-2020 | 2017-2020 |
| Height (with antenna, with roof rail) [mm] | 1652-1654 | 1638-1641 | 1644-1647 |
| Length of load compartment floor [mm] | 860 | 860 | 855 ¹ 91 ² |
| Length of load compartment with folded second row [mm] | 1591 | 1591 | 1616 |
| Load compartment width between wheel arches [mm] | 963 | 963 | 988 |
| Wheelbase [mm] | 2671 | 2672 | 2672 |
| Turning circle diameter [m] | 11.32 | 11.35 | 11.35 |

1) with third row folded

2) with third row unfolded

Capacities

Engine oil

| Engine | EB2LTDEH2 / EB2LTDH2 | EB2LTED |
|-------------------------|----------------------|----------------|
| including filter [l] | 3.6 | — ¹ |
| between MIN and MAX [l] | 1.1 | — ¹ |

1) Not available at time of printing

Fuel tank

| | |
|--------------------------------|----|
| Petrol, refilling quantity [l] | 44 |
|--------------------------------|----|

High voltage battery

| | |
|------------------------------|---------|
| Battery capacity (BEV) [kWh] | 44 / 54 |
|------------------------------|---------|

Tire Pressures

| Tires | Vehicle up to 3 people | | With full load | | Spare wheel |
|-----------------------|----------------------------|---|----------------------------|---------------------------|--------------|
| | Front [kPa/bar] ([psi]) | Rear [kPa/bar] ([psi]) | Front [kPa/bar] ([psi]) | Rear [kPa/bar] ([psi]) | |
| 215/65 R16 | 250/2.5 (36) | 230/2.3 (33) ¹ 240/2.4 (35) ² 250/2.5 (36) ³ | 250/2.5 (36) | 270/2.7 (39) | 270/2.7 (39) |
| 215/60 R17 96H NL | 250/2.5 (36) | 230/2.3 (33) ¹ 240/2.4 (35) ² 250/2.5 (36) ³ | 250/2.5 (36) | 270/2.7 (39) | 270/2.7 (39) |
| 215 60 R17 100V XL | 250/2.5 (36) | 230/2.3 (33) ¹ 240/2.4 (35) ² 250/2.5 (36) ³ | 250/2.5 (36) | 270/2.7(39) | 270/2.7 (39) |

1. Only for ICEs and Hybrid 48 V vehicles with 5 seats.

2. Only for vehicles with 7 seats.

3. Only for BEVs.

Customer Information

| | |
|---|-----|
| Declaration Of Conformity..... | 171 |
| REACH..... | 172 |
| Software Update..... | 172 |
| Registered Trademarks..... | 173 |
| Vehicle Data Recording And Privacy..... | 173 |
| Emergency Call data Recording And Privacy..... | 173 |

Declaration Of Conformity

Transmission systems

This vehicle has systems that transmit and / or receive radio waves subject to Directive 2014/53/EU and The Radio Equipment Regulations 2017 by the United Kingdom. The manufacturers of the systems listed below declare conformity with Directive 2014/53/EU and The Radio Equipment Regulations 2017. The full text of the EU declaration of conformity for each system is available at the following internet address: www.opel.com/conformity.

Importer is Opel Automobile GmbH, Bahnhofplatz, 65423 Ruesselsheim am Main, Germany.

BTA Module

Magneti Marelli S.p.A.
Viale A. Borletti 61/63, 20011 Corbetta, Italy

| Operation frequency (MHz) | Maximum output (dBm) |
|---------------------------|----------------------|
| 880 -915 | 33 |
| 1710 - 1785 | 24 |
| 1850 -1910 | 24 |

1920 - 1980 24

2500 - 2570 23

Antenna module

Laird
Daimlerring 31, 31135 Hildesheim, Germany
Operation frequency: N/A
Maximum output: N/A

Radio remote control transmitter

Hülsbeck & Fürst GmbH & Co. KG
Steeger Str. 17, 42551 Velbert, Germany
Operation frequency: 433.92 MHz
Maximum output: 10 dBm

Radio remote control receiver

Delphi European, Middle Eastern & African Regional Offices Customer Technology
Center Avenue de Luxembourg, L-4940 Bascharage, G.D. of Luxembourg
Operation frequency: 119.0 - 128.6 kHz
Maximum output: 16dB μ A/m @ 10m

Electronic key transmitter

Valeo
43 Rue Bayen, 75017 Paris, France
Operation frequency: 433.92 MHz
Maximum output: 10 dBm

immobilizer

KOSTAL of America, Inc.

350 Stephenson Hwy, Troy MI 48083,
USA

Operation frequency: 125 kHz

Maximum output: 5 dBμA/m at 10m

ICASA type approval numbers

List of all Independent Communications
Authority of South Africa (ICASA) type
approval numbers:

TA-2016/121, TA-2016/3261,

TA-2017/2387, TA-2017/2745,

TA-2013/430, TA-2017/1106,

TA-2016/929, TA-2017/3180

REACH

Registration, Evaluation, Authorization
and Restriction of Chemicals (REACH)
is a European Union regulation adopted
to improve the protection of human
health and the environment from the
risks that can be posed by chemicals.
Visit www.opel.com/reach for further
information and for access to the Article
33 communication.

Software Update

The Infotainment system can download
and install selected software updates
over a wireless connection.

Note

The availability of these over-the-
air vehicle software updates varies
by vehicle and country. Find more
information on our website.

Remote device management and remote software and firmware updates

As an integral part of the service
related to the performance of subscribed
connected service contracts, necessary
device management and necessary
software and firmware updates related
to the software and firmware for the named
connected service will be performed
remotely, in particular by using over-the-
air technology.

For this, a secure radio network
connection between the vehicle and
the device management server will be
established when ignition is switched on
and a mobile network is available.

Depending on the equipment of the
vehicle, connection configuration must
be set to **Connected vehicle** to allow
the establishment of the radio network
connection.

Irrespective of a valid connected
service subscription, remote product
security or product safety related
device management and software and
firmware updates will be performed

when the processing is necessary for
the compliance with a legal obligation
to which the manufacturer is subject
(e.g. applicable product liability law,
emergency call regulation) or when
the processing is necessary in order
to protect the vital interests of the
respective vehicle users and passengers.
The establishment of a secure radio
network connection and the related
remote updates are not affected by
privacy settings and will be performed
in principal after an initiation by the
vehicle user following a respective
notification. The system is able to
notify receipt of an update as soon as
it is connected to an exterior Wi-Fi
network or a mobile network. Large
updates are downloaded only via the
Wi-Fi network.

The availability of an update is
notified on the Info Display at the
end of a trip with an option of
immediate installation or
postponement of installation.

The installation time is variable and
can take several minutes with a
maximum of about 30 minutes. A
notification will give an estimate of
the duration and a description of the
update.

Updates can be checked manually via
the Info Display. Follow the onscreen
prompts in the respective menu.

Note

Steps for downloading and installing updates may vary by vehicle.

For safety reasons and because it requires sustained attention by the driver, the installation must be carried out with the ignition on without starting the engine. The installation cannot be carried out in the following cases:

- engine running
- emergency call in progress
- insufficient vehicle battery charge
- charging the vehicle's high voltage battery

Note

During the installation process, the vehicle may not be operational. If the update has failed, seek the assistance of a workshop.

Registered Trademarks

Apple Inc.

Apple CarPlay™ is a trademark of Apple Inc.

App Store® and iTunes Store® are registered trademarks of Apple Inc. iPhone®, iPod®, iPod touch®, iPod nano®, iPad® and Siri® are registered trademarks of Apple Inc.

Bluetooth SIG, Inc.

Bluetooth® is a registered trademark of Bluetooth SIG, Inc. DivX, LLC DivX® and DivX Certified® are registered trademarks of DivX, LLC.

Google Inc.

Android™ and Google Play™ Store are trademarks of Google Inc.

Velcro Companies

Velcro® is a registered trademark of Velcro Companies.

Vehicle Data Recording And Privacy

Emergency Call Data Recording And Privacy

Data processing

All processing of personal information by the emergency call function complies with the framework for protection of personal information established by regulation 2016/679 (GDPR) and directive 2002/58/EC of the European Parliament and the Council, and in particular, seeks to protect the vital interests of the data subject, in

accordance with article 6.1, paragraph d) of regulation 2016/679.

The processing of personal information is strictly limited to the requirements of the emergency call function used with the European emergency call number.

The emergency call function is only able to collect and process the following data relating to the vehicle: chassis number, type (passenger vehicle or light commercial vehicle), fuel type or power source, three most recent locations and direction of travel, number of passengers and a timestamped log file recording technical data related to the system's operation.

The recipients of the processed data are the emergency call handling centres designated by the relevant national authorities in the territory in which they are located, enabling priority routing and handling of calls to the emergency number.

Data storage

Data contained in the system's memory is not accessible from outside the system until a call is made. The system is not traceable and is not continuously monitored in its normal operation mode. The data in the system's internal memory is automatically and continuously erased. Only the vehicle's three most recent

locations, necessary for the normal functioning of the system, are stored. When an emergency call is triggered, the data log is stored for no more than 13 hours.

Access to data

You have the right to access the data and, if necessary, submit a request to rectify, erase or restrict the processing of any personal information not processed in accordance with the provisions of Regulation 2016/679 (GDPR). Third parties to which data has been communicated shall be notified of any rectification, erasure or restriction carried out in accordance with the aforementioned directive, unless doing so would be impossible or require a disproportionate effort.

You also have the right to lodge a complaint with the relevant data protection authority.

If you want to claim your abovementioned rights please contact us per email at privacyrights@mpsa.com. For more information regarding our contact details please take a look at our Privacy & Cookies Policy on our website.

Event Data Recorders

Electronic control units are installed in your vehicle. Control units process data which is received by vehicle

sensors, for example, or which they generate themselves or exchange amongst themselves. Some control units are necessary for the safe functioning of your vehicle, others assist you while you drive (driver assistance systems), while others provide comfort or infotainment functions.

The following contains general information about data processing in the vehicle. You will find additional information as to which specific data is uploaded, stored and passed on to third parties and for what purpose in your vehicle under the key word Data Protection closely linked to the references for the affected functional characteristics in the relevant owner's manual or in the general terms of sale. These are also available online.

Operating data in the vehicle

Control units process data for operation of the vehicle.

This data includes, for example:

- vehicle status information (e.g. speed, movement delay, lateral acceleration, wheel rotation rate, "seat belts fastened" display)
- ambient conditions (e.g. temperature, rain sensor, distance sensor)

As a rule such data is transient and is not stored for longer than an operational cycle, and only processed on board the vehicle itself. Often control units include data storage (including the vehicle key). This is used to allow information to be documented temporarily or permanently on vehicle condition, component stress, maintenance requirements and technical events and errors.

Depending on technical equipment levels, the data stored is as follows:

- system component operating states (e.g. fill level, tire pressure, battery status)
- faults and defects in important system components (e.g. lights, brakes)
- system reactions in special driving situations (e.g. triggering of an airbag, actuation of the stability control systems)
- information on events damaging the vehicle
- for electric vehicles the amount of charge in the high-voltage battery, estimated range

In special cases (e.g. if the vehicle has detected a malfunction), it may be necessary to save data that would otherwise just be volatile.

When you use services (e.g. repairs, maintenance), the operating data saved can be read together with the vehicle identification number and used where necessary. Staff working for the service network (e.g. garages, manufacturers) or third parties (e.g. breakdown services) can read the data from the vehicle.

The same applies to warranty work and quality assurance measures.

Data is generally read via the OBD (On-Board Diagnostics) port prescribed by law in the vehicle. The operating data read documents the technical condition of the vehicle or individual components and assists with fault diagnosis, compliance with warranty obligations and quality improvement. This data, in particular information on component stress, technical events, operator errors and other faults, is transmitted to the manufacturer where appropriate, together with the vehicle identification number. The manufacturer is also subject to product liability. The manufacturer potentially also uses operating data from vehicles for product recalls. This data can also be used to check customer warranty and guarantee claims.

Fault memories in the vehicle can be reset by a service company when

carrying out servicing or repairs or at your request.

Comfort and infotainment functions

Comfort settings and custom settings can be stored in the vehicle and changed or reset at any time.

Depending on the equipment level in question, these include

- seat and steering wheel position settings
- chassis and air conditioning settings
- custom settings such as interior lighting

You can input your own data in the infotainment functions for your vehicle as part of the selected features.

Depending on the equipment level in question, these include

- multimedia data such as music, videos or photos for playback in an integrated multimedia system
- address book data for use with an integrated hands-free system or an integrated navigation system
- input destinations
- data on the use of online services

This data for comfort and infotainment functions can be stored locally in the vehicle or be kept on a device that you

have connected to the vehicle (e.g. a smartphone, USB stick or MP3 player). Data that you have input yourself can be deleted at any time.

This data can only be transmitted out of the vehicle at your request, particularly when using online services in accordance with the settings selected by you.

Smartphone integration, e.g. Android Auto or Apple CarPlay

If your vehicle is equipped accordingly, you can connect your smartphone or another mobile device to the vehicle so that you can control it via the controls integrated in the vehicle. The smartphone image and sound can be output via the multimedia system in this case. At the same time, specific information is transmitted to your smartphone.

Depending on the type of integration, this includes data such as position data, day / night mode and other general vehicle information. For more information, please see the operating instructions for the vehicle / infotainment system.

Integration allows selected smartphone apps to be used, such as navigation or music playback. No further integration is possible between smartphone and vehicle, in particular active access to vehicle data. The nature of further data

processing is determined by the provider of the app used. Whether you can define settings, and if so which ones, is dependent on the app in question and your smartphone's operating system.

Online services

If your vehicle has a radio network connection, this allows data to be exchanged between your vehicle and other systems. The radio network connection is made possible by means of a transmitter device in your vehicle or a mobile device provided by you (e.g. a smartphone). Online functions can be used via this radio network connection. These include online services and applications / apps provided to you by the manufacturer or other providers.

Proprietary services

In the case of the manufacturer's online services, the relevant functions are described by the manufacturer in an appropriate location (e.g. Owner's Manual, the manufacturer's website) and the associated data protection information is provided. Personal data may be used to provide online services. Data exchange for this purpose takes place via a protected connection, e.g. using the manufacturer's IT systems provided for the purpose. Collection,

processing and use of personal data for the purposes of preparation of services take place solely on the basis of legal permission, e.g. in the case of a legally prescribed emergency communication system or a contractual agreement, or by virtue of consent.

You can activate or deactivate the services and functions (which are subject to charges to some extent) and, in some cases, the vehicle's entire radio network connection. This does not include statutory functions and services such as an emergency communication system.

Onboard fuel consumption meter (OBFCM)

This function will be provided for the entire life cycle of the vehicle. In accordance to Article 9 of Implementing Regulation (EU) 2021/392 ("OBFCM"), this regulatory service allows the European Environment Agency (EEA) to collect vehicle data related to usage (such as VIN, total distance travelled, total fuel consumed, total grid energy into battery when applicable). These data are used by EEA to monitor in real usage the fuel and energy consumption and the CO2 emission of the new vehicles in an anonymized and aggregated way.

The collection and transmission of vehicle's data for regulatory OBFCM purpose can be refused. This can be done by contacting Customer Care Center (contact details available online).

Third party services

If you make use of online services from other providers (third parties), these services are subject to the liability and data protection and usage conditions of the provider in question.

The manufacturer frequently has no influence over the content exchanged in this regard.

Therefore, please note the nature, scope and purpose of the collection and use of personal data within the scope of third party services provided by the service provider in question.

In case of an accident

This vehicle is fitted with an event data recorder. This system gathers and records certain vehicle data over a short period (a few seconds) before, during and after an event such as an accident or collision. In order to gain a better understanding of the circumstances surrounding the event, the system records how the vehicle's various

systems are operating at the time of the event, including:

- any deployment of a restraint system (airbag, seat belt, etc)
- the status of all seat belts (fastened / unfastened)
- the contact or intensity of pressure exerted on the pedal(s) engaged by the driver
- the speed of the vehicle
- the status of some driving and driver assistance systems.

The following are not recorded:

- data on normal driving conditions, in other words data not directly related to the event
- personal data on the driver and any other occupants
- the geographical location of the vehicle at the time of the event.

The reading of data recorded by the event data recorder requires both:

- access to the interior of the vehicle or to the event data recorder
- special equipment that can be purchased from the manufacturer Bosch.

Aside from the vehicle manufacturer, other parties such as law enforcement agencies may access this data in order to analyse the event.

Radio Frequency Identification (RFID)

RFID technology is used in some vehicles for functions such as immobilizer. It is also used in connection with conveniences such as radio remote controls for door locking / unlocking and starting. RFID technology in Opel vehicles does not use or record personal information or link with any other Opel system containing personal information.

Index

| | |
|--|----------|
| Numerics | |
| 48 V | 3 |
| A | |
| ABS | 99 |
| Accessories | 137 |
| Active emergency braking | 116 |
| ADAS | 116 |
| Advanced driving assistance system | 116 |
| Air conditioning | 86 |
| Air intake | 88 |
| Air vents | 87 |
| Airbag | 22 |
| Airbag, child restraint | 22 |
| Airbag, curtain | 25 |
| Airbag, deactivation | 25 |
| Airbag, front | 24 |
| Airbag, side | 25 |
| Android Auto | 72 |
| Anti-theft system | 8 |
| Apple CarPlay | 71 |
| Automatic light control | 77 |
| Automatic transmission | 94 |
| Automatic transmission (hybrid) | 95 |
| B | |
| Battery, discharge protection | 82 |
| BEV | 3 |
| Bluetooth | 70, 73 |
| Bonnet | 140 |
| Bonnet, open | 140 |
| Brake assist | 101 |
| Brake fluid | 143, 164 |
| Brakes | 99, 143 |
| Bulb replacement | 145 |
| C | |
| Capacities | 169 |
| Child lock | 7 |
| Child restraint | 26 |
| Child seats, ISOFIX | 27 |
| Coolant, antifreeze | 164 |
| Cruise control | 131 |
| Cruise control, deactivation | 132 |
| D | |
| Defrosting | 86 |
| Doors | 8 |
| Driver drowsiness detection | 131 |
| E | |
| Engine coolant | 142 |
| Engine data | 167 |
| Engine oil | 141, 163 |
| Exhaust filter | 93 |
| Exterior care | 160 |
| F | |
| First aid kit | 38 |
| Fog lights, front | 79 |
| Fog lights, rear | 79 |
| Folding the backrest | 19 |
| Forward collision warning | 119 |
| Fuel | 109 |
| Fuel consumption | 111 |
| G | |
| Glove box | 36 |

| | | | |
|-------------------------------|-----|---------------------------------------|----------|
| H | | | |
| Head restraints, front | 16 | Locking, automatic | 6 |
| Head restraints, rear | 17 | Locks | 160 |
| Headlight, adjustment | 78 | M | |
| Headlight, flash | 78 | Manual seat adjustment | 18 |
| Headlight, high beam | 77 | Mats | 161 |
| Headlight, light switch | 76 | Media | 73 |
| Headlights, LED | 80 | Mirror Screen | 71 |
| Heated seats | 19 | Mirrors | 11, 12 |
| Hybrid | 3 | Mirrors, exterior | 11 |
| I | | Mirrors, folding | 11 |
| ICE | 3 | Mirrors, interior | 12 |
| Ignition | | N | |
| Steering wheel lock | 90 | Navigation | 69 |
| Infotainment, menu | 65 | O | |
| Infotainment, settings | 74 | Opel connect | 59 |
| Interior care | 161 | P | |
| Interior lights | 81 | Park assist | 127 |
| ISOFIX mountings | 32 | Parking assist | 127 |
| J | | Parking brake | 100 |
| Jack | 154 | Pedals | 89 |
| Jump starting | 157 | Phone | 73 |
| K | | Phone, call | 73 |
| Key, replacing battery | 5 | Power saving mode | 144 |
| Keys | 4 | Propulsion type | 3 |
| L | | R | |
| Lane keeping assist | 125 | Radio | 67 |
| Lashing eyes | 38 | Radio, digital (Dugutak Audio | |
| Lighting features | 82 | Broadcasting - DAB) | 68 |
| Lights, parking | 80 | Reading lights | 81 |
| | | Rear camera | 129 |
| | | Rear seats | 19 |
| | | Recommended fluids | 163 |
| | | Recommended lubricants | 163 |
| | | Refueling | 110 |
| | | Reverse parking | 80 |
| | | Roof rack, mounting | 38 |
| | | S | |
| | | Seat belts reminder | 20 |
| | | Seat belts, three-point | 21 |
| | | Seat position | 17 |
| | | Service display | 55 |
| | | Smartphone station | 63 |
| | | Spare wheel | 154 |
| | | Speed Limiter | 132 |
| | | Start - stop | 91 |
| | | Steering wheel, controls | 66 |
| | | T | |
| | | Tail lights | 76 |
| | | Tire chains | 150 |
| | | Tire designations | 148 |
| | | Tire pressure | 148 |
| | | Tire pressure monitoring system | 133 |
| | | Tire repair kit | 150 |
| | | Tires | 147 |
| | | Tools | 147 |
| | | Towing | 112, 113 |
| | | Towing another vehicle | 159 |
| | | Towing eye | 159 |
| | | Towing the vehicle | 158 |
| | | Traffic sign assist | 134 |
| | | Tread depth | 149 |
| | | Turn lights | 79 |

V

| | |
|----------------------------------|-----|
| Vehicle battery | 143 |
| Vehicle battery, replacing | 144 |
| Vehicle messages | 58 |
| Vehicle storage | 138 |
| Voice commands | 66 |

W

| | |
|--------------------------------------|----------|
| Warning triangle | 38 |
| Washer fluid | 143, 164 |
| Washing | 160 |
| Wheel changing | 153 |
| Wheel covers | 149 |
| Windows | 13 |
| Windows, child lock | 14 |
| Winter tires | 147 |
| Wiper replacement, rear window | 145 |
| Wiper replacement, windscreen | 145 |



www.opel.com

Copyright by Opel Automobile GmbH, Rüsselsheim, Germany.

The information contained in this publication is effective as of the date indicated below. Opel Automobile GmbH reserves the right to make changes to the technical specifications, features and design of the vehicles relative to the information in this publication as well as changes to the publication itself.

Edition: March 2025, Opel Automobile GmbH, Rüsselsheim.

Printed on chlorine-free bleached paper.

OFRONCO2503en-1

