

CASCADA

Owner's Manual



Contents

Introduction	2
In brief	6
Keys, doors and windows	21
Seats, restraints	47
Storage	70
Instruments and controls	78
Lighting	114
Climate control	127
Driving and operating	137
Vehicle care	190
Service and maintenance	235
Technical data	239
Customer information	250
Index	260

Introduction

Fuel	Designation	<input type="text"/>		
Engine oil	Grade	<input type="text"/>		
	Viscosity	<input type="text"/>		
Tyre pressure	Tyre size		Front	Rear
	Summer tyres	<input type="text"/>	<input type="text"/>	<input type="text"/>
	Winter tyres	<input type="text"/>	<input type="text"/>	<input type="text"/>
Weights	Gross vehicle weight rating	<input type="text"/>		
	- Kerb weight, basic model	<input type="text"/>		
	= Loading	<input type="text"/>		

Vehicle specific data

Please enter your vehicle's data on the previous page to keep it easily accessible. This information is available in the sections "Service and maintenance" and "Technical data" as well as on the identification plate.

Introduction

Your vehicle is a designed combination of advanced technology, safety, environmental friendliness and economy.

This Owner's Manual provides you with all the necessary information to enable you to drive your vehicle safely and efficiently.

Make sure your passengers are aware of the possible risk of accident and injury which may result from improper use of the vehicle.

You must always comply with the specific laws and regulations of the country that you are in. These laws may differ from the information in this Owner's Manual.

Disregarding the description given in this manual may affect your warranty.

When this Owner's Manual refers to a workshop visit, we recommend your Opel Service Partner.

All Opel Service Partners provide first-class service at reasonable prices. Experienced mechanics trained by Opel work according to specific Opel instructions.

The customer literature pack should always be kept ready to hand in the vehicle.

Using this manual

- This manual describes all options and features available for this model. **Certain descriptions, including those for display and menu functions, may not apply to your vehicle due to model variant, country specifications, special equipment or accessories.**
- The "In brief" section will give you an initial overview.
- The table of contents at the beginning of this manual and within each section shows where the information is located.

- The index will enable you to search for specific information.
- This Owner's Manual depicts left-hand drive vehicles. Operation is similar for right-hand drive vehicles.
- The Owner's Manual uses the engine identifier code. The corresponding sales designation and engineering code can be found in the section "Technical data".
- Directional data, e.g. left or right, or front or back, always relate to the direction of travel.
- Displays may not support your specific language.
- Display messages and interior labelling are written in **bold** letters.

Danger, Warnings and Cautions

Danger

Text marked ** Danger** provides information on risk of fatal injury. Disregarding this information may endanger life.

Warning

Text marked ** Warning** provides information on risk of accident or injury. Disregarding this information may lead to injury.

Caution

Text marked **Caution** provides information on possible damage to the vehicle. Disregarding this information may lead to vehicle damage.

Symbols

Page references are indicated with ⇨.
⇨ means "see page".

Page references and index entries refer to the indented headings given in the section table of content.

We wish you many hours of pleasurable driving.

Your Opel Team

In brief

Initial drive information

Vehicle unlocking



Press  briefly to unlock the doors and boot lid. Open the doors by pulling the handles.

When a door is being opened, the window lowers slightly. It will raise automatically when the door is being closed.

Soft top ⇨ 36, Windows ⇨ 33.

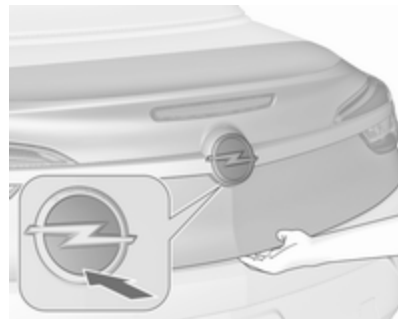

To open the boot lid, push the brand emblem at the bottom half.

Pressing  opens the boot lid while the vehicle remains locked.

Radio remote control ⇨ 22, Central locking system ⇨ 23, Load compartment ⇨ 26.

Seat adjustment

Longitudinal adjustment



Pull handle, slide seat, release handle. Try to move the seat back and forth to ensure that the seat is locked in place.

Seat position ⇨ 49, Manual seat adjustment ⇨ 50, Power seat adjustment ⇨ 53.

Backrest inclination



Turn lever to the rear, adjust inclination and release lever. Allow the seat to engage audibly.

Seat position ⇨ 49, Manual seat adjustment ⇨ 50, Power seat adjustment ⇨ 53, Seat folding ⇨ 52.

Seat height

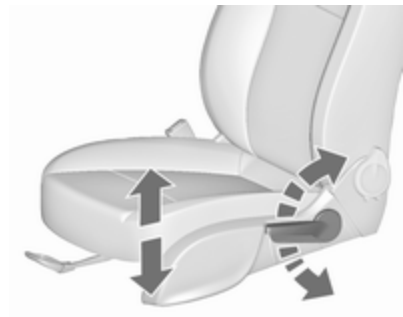

Lever pumping motion

up : seat higher
down : seat lower

Seat position ⇨ 49, Manual seat adjustment ⇨ 50, Power seat adjustment ⇨ 53.

Head restraint adjustment



Press release button, adjust height, engage.

Head restraints ⇨ 47.

Seat belt



Pull out the seat belt and fasten in belt buckle. The seat belt must not be twisted and must fit close against the body. The backrest must not be tilted back too far (maximum approx. 25 °).

To unfasten belt, press red button on belt buckle.

Seat position ⇨ 49, Seat belts ⇨ 56, Seat belt presenter ⇨ 56, Airbag system ⇨ 59.

Mirror adjustment

Interior mirror



To adjust the mirror, move the mirror housing in the desired direction.

Manual anti-dazzle interior mirror ⇨ 32.

Automatic anti-dazzle interior mirror ⇨ 32.

Exterior mirrors

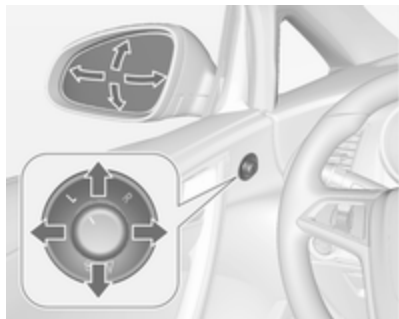

Select the relevant exterior mirror and adjust it.

Convex exterior mirrors ⇨ 30,
Electric adjustment ⇨ 30, Folding
exterior mirrors ⇨ 31, Heated
exterior mirrors ⇨ 31.

Steering wheel adjustment



Unlock the lever, adjust the steering
wheel, then engage the lever and
ensure it is fully locked.

Do not adjust the steering wheel
unless the vehicle is stationary and
the steering wheel lock has been
released.

Airbag system ⇨ 59, Ignition
positions ⇨ 139.

Instrument panel overview

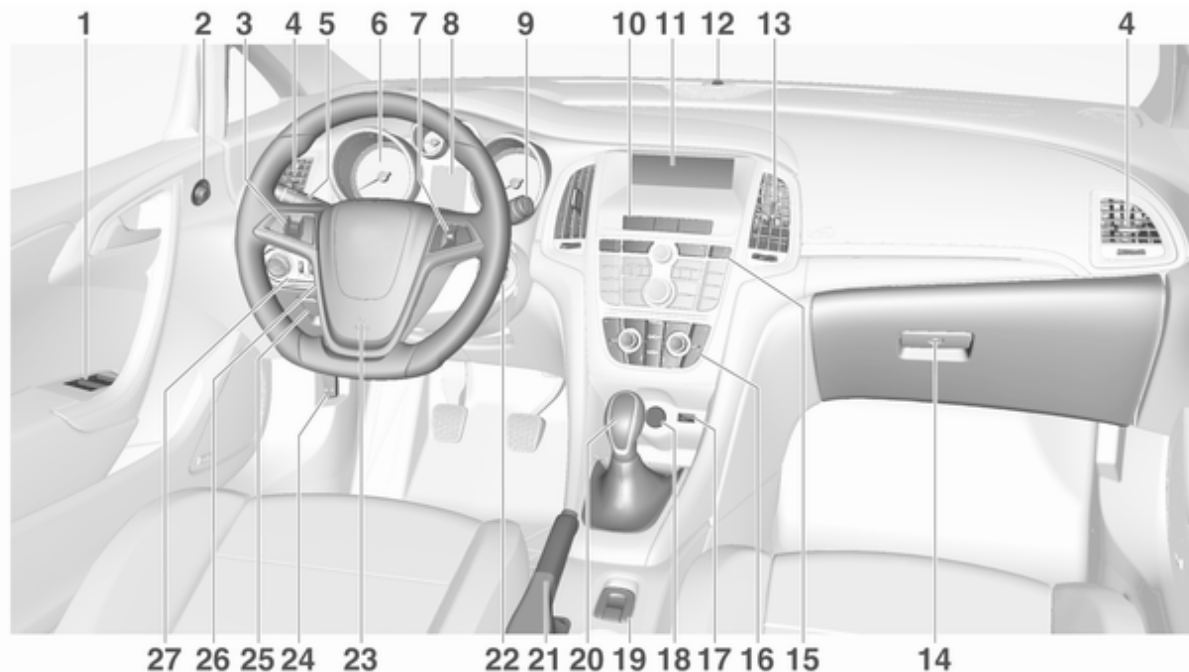

<p>1 Power windows 33</p> <p>2 Exterior mirrors 30</p> <p>3 Cruise control 159</p> <p style="padding-left: 20px;">Speed limiter 161</p> <p style="padding-left: 20px;">Forward collision alert 162</p> <p>4 Side air vents 135</p> <p>5 Turn and lane-change signals, headlight flash, low beam and high beam, high beam assist 122</p> <p style="padding-left: 20px;">Exit lighting 125</p> <p style="padding-left: 20px;">Parking lights 123</p> <p style="padding-left: 20px;">Buttons for Driver Information Centre 96</p> <p>6 Instruments 85</p> <p>7 Steering wheel controls 79</p> <p>8 Driver Information Centre 96</p> <p>9 Windscreen wiper, windscreen washer system, headlight washer system 80</p> <p>10 Sport mode 157</p> <p style="padding-left: 20px;">Central locking system 23</p>	<p style="padding-left: 20px;">Hazard warning flashers 121</p> <p style="padding-left: 20px;">Control indicator for airbag deactivation 91</p> <p style="padding-left: 20px;">Control indicator for front passenger seat belt 91</p> <p style="padding-left: 20px;">Tour mode 157</p> <p>11 Info Display 101</p> <p>12 Anti-theft alarm system status LED 28</p> <p>13 Centre air vents 135</p> <p>14 Glovebox, lockable 70</p> <p>15 Traction Control system (TC) 155</p> <p style="padding-left: 20px;">Electronic Stability Control (ESC) 156</p> <p style="padding-left: 20px;">Parking assist systems 165</p> <p style="padding-left: 20px;">Lane departure warning 179</p> <p style="padding-left: 20px;">Eco button for stop-start system 140</p> <p>16 Climate control system 127</p> <p>17 AUX input, USB input 10</p> <p>18 Power outlet 83</p>	<p>19 Soft top operation switch 36</p> <p style="padding-left: 20px;">Central window switch 33</p> <p>20 Selector lever, transmission</p> <p>21 Parking brake, manual or electric operation 153</p> <p>22 Ignition switch with steering wheel lock 139</p> <p>23 Horn 80</p> <p style="padding-left: 20px;">Driver airbag 62</p> <p>24 Bonnet release lever 192</p> <p>25 Storage compartment 71</p> <p style="padding-left: 20px;">Fuse box 209</p> <p>26 Steering wheel adjustment . . 79</p> <p>27 Light switch 114</p> <p style="padding-left: 20px;">Rear fog light 122</p> <p style="padding-left: 20px;">Instrument illumination 123</p> <p style="padding-left: 20px;">Headlight range adjustment 117</p> <p style="padding-left: 20px;">Front fog lights 122</p>
--	--	--

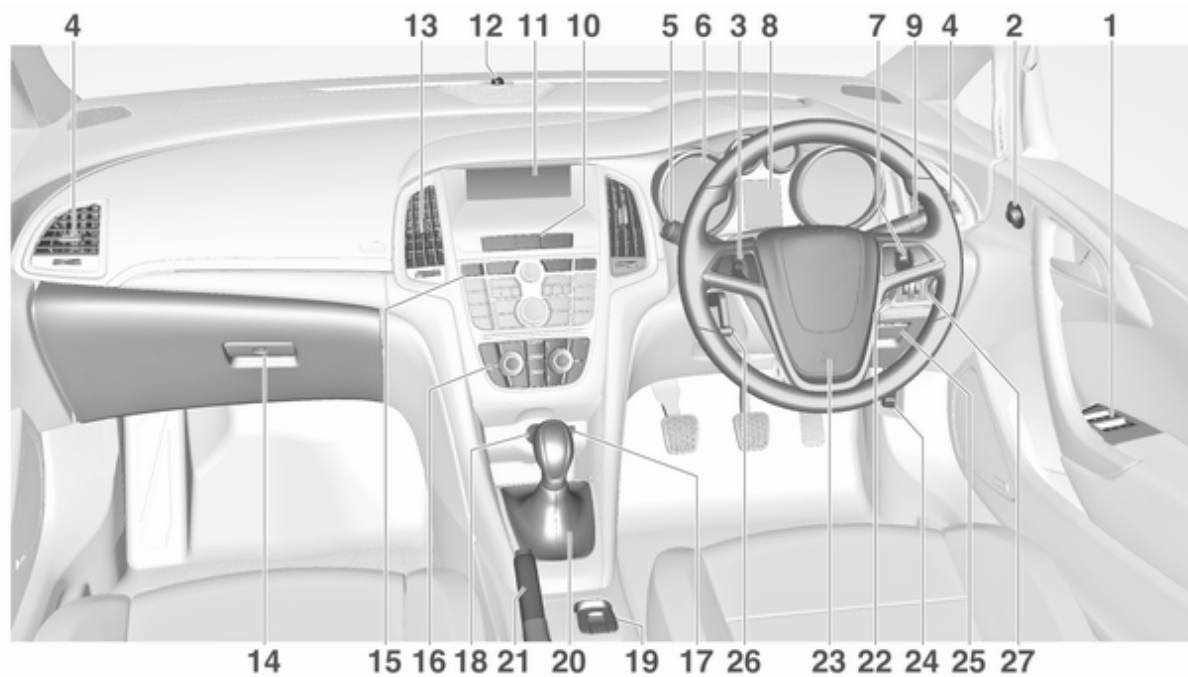

<p>1 Power windows 33</p> <p>2 Exterior mirrors 30</p> <p>3 Cruise control 159</p> <p style="padding-left: 20px;">Speed limiter 161</p> <p style="padding-left: 20px;">Forward collision alert 162</p> <p>4 Side air vents 135</p> <p>5 Turn and lane-change signals, headlight flash, low beam and high beam, high beam assist 122</p> <p style="padding-left: 20px;">Exit lighting 125</p> <p style="padding-left: 20px;">Parking lights 123</p> <p style="padding-left: 20px;">Buttons for Driver Information Centre 96</p> <p>6 Instruments 85</p> <p>7 Steering wheel controls 79</p> <p>8 Driver Information Centre 96</p> <p>9 Windscreen wiper, windscreen washer system, headlight washer system 80</p> <p>10 Sport mode 157</p> <p style="padding-left: 20px;">Central locking system 23</p>	<p style="padding-left: 20px;">Hazard warning flashers 121</p> <p style="padding-left: 20px;">Control indicator for airbag deactivation 91</p> <p style="padding-left: 20px;">Control indicator for front passenger seat belt 91</p> <p style="padding-left: 20px;">Tour mode 157</p> <p>11 Info Display 101</p> <p>12 Anti-theft alarm system status LED 28</p> <p>13 Centre air vents 135</p> <p>14 Glovebox, lockable 70</p> <p style="padding-left: 20px;">Fuse box 209</p> <p>15 Traction Control system (TC) 155</p> <p style="padding-left: 20px;">Electronic Stability Control (ESC) 156</p> <p style="padding-left: 20px;">Parking assist systems 165</p> <p style="padding-left: 20px;">Lane departure warning 179</p> <p style="padding-left: 20px;">Eco button for stop-start system 140</p> <p>16 Climate control system 127</p> <p>17 AUX input, USB input 10</p> <p>18 Power outlet 83</p>	<p>19 Soft top operation switch 36</p> <p style="padding-left: 20px;">Central window switch 33</p> <p>20 Selector lever, transmission</p> <p>21 Parking brake, manual or electric operation 153</p> <p>22 Ignition switch with steering wheel lock 139</p> <p>23 Horn 80</p> <p style="padding-left: 20px;">Driver airbag 62</p> <p>24 Bonnet release lever 192</p> <p>25 Storage compartment 71</p> <p style="padding-left: 20px;">Fuse box 209</p> <p>26 Steering wheel adjustment . . 79</p> <p>27 Light switch 114</p> <p style="padding-left: 20px;">Rear fog light 122</p> <p style="padding-left: 20px;">Instrument illumination 123</p> <p style="padding-left: 20px;">Headlight range adjustment 117</p> <p style="padding-left: 20px;">Front fog lights 122</p>
--	---	--

Exterior lighting

Light switch



Turn light switch:

- O** : lights off
- ↔** : sidelights
- ≡D** : headlights

Light switch with automatic light control



- AUTO** : automatic light control:
headlights are switched on
and off automatically
- ☰** : activation or deactivation of
the automatic light control
- ↔** : sidelights
- ≡D** : headlights

Fog lights

Press light switch:

≡D : front fog lights

⊙≡ : rear fog light

Lighting ⇨ 114.

Headlight flash, high beam and low beam

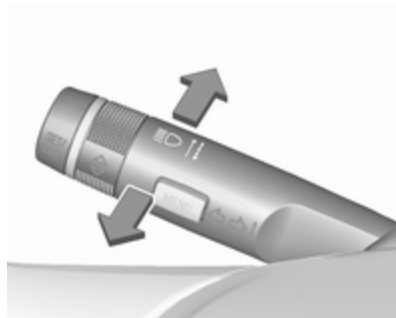

- headlight flash : pull lever
- high beam : push lever
- low beam : pull lever

High beam ⇨ 116, Headlight flash
⇨ 117.

Automatic light control ⇨ 115, High
beam assist ⇨ 116, Adaptive forward
lighting ⇨ 118.

Turn and lane-change signals



lever up : right turn signal
lever down : left turn signal

Turn and lane-change signals
↪ 122, Parking lights ↪ 123.

Hazard warning flashers



Operated by pressing .
Hazard warning flashers ↪ 121.

Horn



Press .

Washer and wiper systems

Windscreen wiper

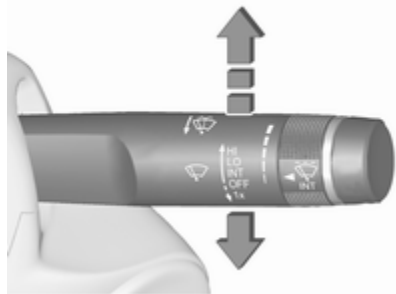

HI : fast

LO : slow

INT : interval wiping

or

automatic wiping with rain sensor

OFF : off

For a single wipe when the windscreen wiper is off, press the lever down to position **1x**.

Windscreen wiper ⇨ 80.

Windscreen and headlight washer systems



Pull lever.

Windscreen and headlight washer system ⇨ 80, Washer fluid ⇨ 195.

Climate control

Heated rear window, heated exterior mirrors



The heating is operated by pressing .

Heated rear window ⇨ 35.

Demisting and defrosting the windows, Air conditioning system



Press .

Set the temperature control to the highest level.

Switch on heated rear window .

Air conditioning system ⇨ 128.

Demisting and defrosting the windows, Electronic climate control



Press .

Temperature and air distribution are set automatically and the fan runs at high speed.

Switch on heated rear window .

Electronic climate control ⇨ 130.

Transmission

Manual transmission



Reverse: with the vehicle stationary, depress clutch pedal, press the release button on the selector lever and engage the gear.

If the gear does not engage, set the lever to neutral, release the clutch pedal and depress again; then repeat gear selection.

Manual transmission ⇨ 152.

Automatic transmission

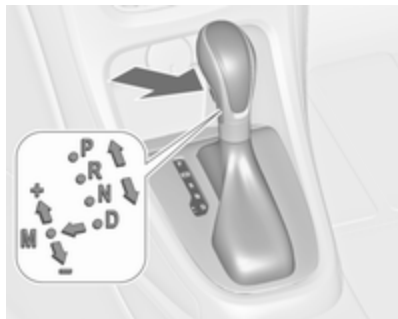

- P** : park
- R** : reverse
- N** : neutral
- D** : automatic mode
- M** : manual mode: move selector lever from **D** to the left.
- +** : manual mode upshifting
- : manual mode downshifting

The selector lever can only be moved out of **P** when the ignition is on and the brake pedal is applied. To engage **P** or **R**, press the release button.

Automatic transmission ⇨ 148.

Starting off

Check before starting off

- Tyre pressure and condition
⇨ 217, ⇨ 248.
- Engine oil level and fluid levels
⇨ 193.
- All windows, mirrors, exterior lighting and number plates are free from dirt, snow and ice and are operational.
- Proper position of mirrors, seats and seat belts ⇨ 30, ⇨ 49, ⇨ 57.
- Soft top must be completely opened or closed ⇨ 36.
- Brake function at low speed, particularly if the brakes are wet.

Starting the engine

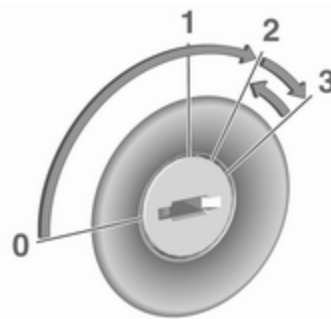

- Turn key to position **1**.
- Move the steering wheel slightly to release the steering wheel lock.
- Manual transmission: operate clutch and brake pedal.
Automatic transmission: operate brake pedal and move selector to **P** or **N**.
- Do not operate accelerator pedal.

- Diesel engines: turn the key to position **2** for preheating and wait until control indicator  extinguishes.
- Turn key to position **3** and release.

Starting the engine ⇨ 139.

Stop-start system



If the vehicle is at a low speed or at a standstill and certain conditions are fulfilled, activate an Autostop as follows:

- Depress the clutch pedal.
- Engage neutral gear.
- Release the clutch pedal.

An Autostop is indicated by the needle at the **AUTOSTOP** position in the tachometer.

To restart the engine, depress the clutch pedal again.

Stop-start system ⇨ 140.

Parking

Warning

- Do not park the vehicle on an easily ignitable surface. The high temperature of the exhaust system could ignite the surface.
- Always apply the parking brake. Activate the manual parking brake without pressing the release button. Apply as firmly as possible on a downhill slope or uphill slope. Depress brake pedal at the same time to reduce operating force.

For vehicles with electric parking brake, pull switch  for approx. one second.

The electric parking brake is applied when control indicator  illuminates ⇨ 92.

- Switch off the engine.
- If the vehicle is on a level surface or uphill slope, engage first gear or set the selector

lever to position **P** before removing the ignition key. On an uphill slope, turn the front wheels away from the kerb.

If the vehicle is on a downhill slope, engage reverse gear or set the selector lever to position **P** before removing the ignition key. Turn the front wheels towards the kerb.

- Close the windows and the soft top.
- Remove the ignition key from the ignition switch. Turn the steering wheel until the steering wheel lock is felt to engage.

For vehicles with automatic transmission, the key can only be removed when the selector lever is in position **P**.



- Lock the vehicle with  on the radio remote control.

Activate the anti-theft alarm system  28.

- The engine cooling fans may run after the engine has been switched off  192.

Caution

After running at high engine speeds or with high engine loads, operate the engine briefly at a low load or run in neutral for approx. 30 seconds before switching off, in order to protect the turbocharger.

Keys, locks  21, Laying the vehicle up for a long period of time  191.

Keys, doors and windows

Keys, locks	21
Keys	21
Car Pass	22
Radio remote control	22
Memorised settings	23
Central locking system	23
Automatic locking	25
Doors	26
Load compartment	26
Vehicle security	27
Anti-theft locking system	27
Anti-theft alarm system	28
Immobiliser	30
Exterior mirrors	30
Convex shape	30
Electric adjustment	30
Folding mirrors	31
Heated mirrors	31
Interior mirrors	32
Manual anti-dazzle	32
Automatic anti-dazzle	32
Windows	32
Windscreen	32

Power windows	33
Heated rear window	35
Sun visors	35
Roof	36
Soft top	36
Wind deflector	43
Rollover protection system	45

Keys, locks

Keys

Caution
Do not attach heavy or bulky items to the ignition key.

Replacement keys

The key number is specified in the Car Pass or on a detachable tag.

The key number must be quoted when ordering replacement keys as it is a component of the immobiliser system.

Locks ⇨ 232.

The code number of the adapter for the locking wheel nuts is specified on a card. It must be quoted when ordering a replacement adapter.

Wheel changing ⇨ 222.

Key with foldaway key section



Press button to extend. To fold the key, first press the button.

Car Pass

The Car Pass contains security related vehicle data and should therefore be kept in a safe place.

When the vehicle is taken to a workshop, this vehicle data is needed in order to perform certain operations.

Radio remote control



Used to operate:

- central locking system
- anti-theft locking system
- anti-theft alarm system
- soft top
- power windows

The radio remote control has a range of approx. 20 metres. It can be restricted by external influences. The hazard warning flashers confirm operation.

Handle with care, protect from moisture and high temperatures and avoid unnecessary operation.

Fault

If the central locking system cannot be operated with the radio remote control, it may be due to the following:

- Range is exceeded.
- Battery voltage is too low.
- Frequent, repeated operation of the radio remote control while not in range, which will require re-synchronisation.
- Overload of the central locking system by operating at frequent intervals, the power supply is interrupted for a short time.
- Interference from higher-power radio waves from other sources.

Unlocking ⇨ 23.

Basic settings

Some settings can be changed in the Settings menu in the Info-Display. Vehicle personalisation ⇨ 104.

Radio remote control battery replacement

Replace the battery as soon as the range reduces.



Batteries do not belong in household waste. They must be disposed of at an appropriate recycling collection point.

Key with foldaway key section

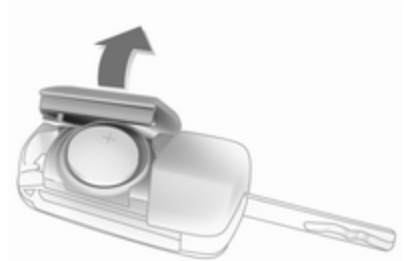

Extend the key and open the unit sideways. Replace the battery (battery type CR 2032), paying attention to the installation position. Close the unit and synchronise.

Memorised settings

Whenever the key is removed from the ignition switch, the following settings are automatically memorised by the key:

- lighting
- presets for Infotainment system
- central locking system
- Sport mode settings
- comfort settings

The saved settings are automatically used the next time the memorised key is inserted into the ignition switch and turned to position 1 ↻ 139.

Graphic-Info-Display

A precondition is that **Personalization by driver** is activated in the personal settings. This must be set for each key used.

Colour-Info-Display

The personalisation is permanently activated.

Vehicle personalisation ↻ 104.

Central locking system

Unlocks and locks doors, load compartment and fuel filler flap.

A pull on an interior door handle unlocks the respective door. Pulling the handle once more opens the door.

Note

In the event of an accident in which airbags or belt pretensioners are deployed, the vehicle is automatically unlocked.

Note





A short time after unlocking with the remote control, the doors are relocked automatically if no door has been opened.

Unlocking



Press .

Two settings are selectable:

- To unlock only the driver's door and fuel filler flap, press  once. To unlock all doors, press  twice. Press  again and hold to open the windows and the soft top  33.
- Press  once to unlock all doors, load compartment and fuel filler flap.

The setting can be changed in the Settings menu in the Info-Display. Vehicle personalisation  104.

The setting can be saved for the key being used.

Memorised settings  23.

Unlocking and opening the boot lid  26.



Locking

Close doors, load compartment and fuel filler flap.



Press  briefly.

If the driver's door is not closed properly, the central locking system will not work.

Press and hold  again to close the soft top and the windows  33.

Central locking buttons

Locks or unlocks both doors, the load compartment and fuel filler flap from the passenger compartment.



Press  to lock.

Press  to unlock.

Fault in radio remote control system

Unlocking



Manually unlock the driver's door by turning the key in the lock. Switch on the ignition and press the central locking button  to unlock passenger's door, load compartment and fuel filler flap.

By switching on the ignition, the anti-theft locking system is deactivated.

Locking

Manually lock the driver's door by turning the key in the lock.

Fault in central locking system

Unlocking

Manually unlock the driver's door by turning the key in the lock. The passenger's door can be opened by pulling the interior handle twice. The load compartment and fuel filler flap cannot be opened.

To deactivate the anti-theft locking system, switch on the ignition  28.

Locking

Push inside locking knob of passenger's door. Then close the driver's door and lock it from the outside with the key. The fuel filler flap and tailgate cannot be locked.

Manual closing of the soft top

 36.

Automatic locking

This security feature can be configured to automatically lock the doors, load compartment and fuel filler flap as soon as a certain speed is exceeded.

Additionally, it is configurable to unlock the driver's door or both doors after the ignition is switched off and the ignition key is removed (manual transmission) or the selector lever is moved to position **P** (automatic transmission).

Settings can be changed in the Settings menu in the Info-Display. Vehicle personalisation  104.

The settings can be saved for the key being used  23.

Doors

Load compartment

Boot lid

Opening

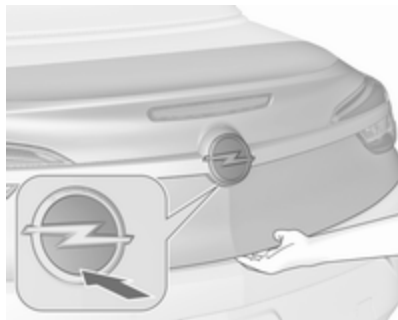

Press  on the radio remote control or push the brand emblem at the bottom half after unlocking to open the boot lid.



Pressing  opens the boot lid while the vehicle remains locked.

Central locking system ⇨ 23.

Load compartment ⇨ 73.

Closing

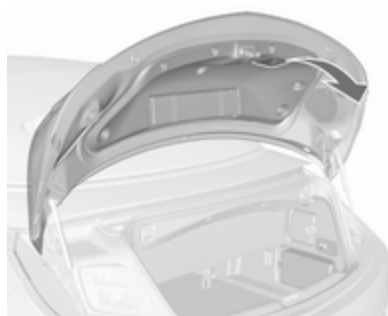

Use the interior handle.

Do not touch the brand emblem whilst closing as this could unlock the boot lid again.

Central locking system ⇨ 23.

Blockage of boot lid

The boot lid can only be opened when the soft top is completely opened or closed. The soft top lid must be closed.

Manual closing of the soft top ⇨ 36.

Blockage of soft top

The soft top can only be operated when the boot lid is closed.

General hints for operating the boot lid**⚠ Danger**

Do not drive with the boot lid open or ajar, e.g. when transporting bulky objects, since toxic exhaust gases, which cannot be seen or smelled, could enter the vehicle. This can cause unconsciousness and even death.

Caution

Before opening the boot lid check overhead obstructions, such as a garage door, to avoid damage to the boot lid. Always check the moving area above and behind the boot lid.

Note

The installation of certain heavy accessories onto the boot lid may affect its ability to remain open.

Vehicle security**Anti-theft locking system****⚠ Warning**

Do not use the system if there are people in the vehicle! The doors cannot be unlocked from the inside.

The system deadlocks the doors. The doors must be closed otherwise the system cannot be activated.

Unlocking the vehicle disables the mechanical anti-theft locking system. This is not possible with the central locking button.

Activating



Press  on the radio remote control twice briefly within 15 seconds. Long press will activate soft top closing.

Anti-theft alarm system



The anti-theft alarm system is combined with the anti-theft locking system.

It monitors:

- doors, boot lid, bonnet
- passenger compartment including adjoining load compartment

- vehicle inclination, e.g. if it is raised
- ignition

Activation

- Self-activated 30 seconds after locking the vehicle by pressing  once.
- Directly by pressing  twice briefly within five seconds. Long press will activate soft top closing.



Note

Changes to the vehicle interior, such as the use of seat covers and open windows, could impair the function of passenger compartment monitoring.

Activation without monitoring of passenger compartment and vehicle inclination



Switch off the monitoring of passenger compartment and vehicle inclination when e.g. animals are being left in the vehicle, because of high volume ultrasonic signals or due to movements triggering the alarm. Also switch off when the vehicle is on a ferry or train.

1. Close boot lid, bonnet, windows and soft top.
2. Press . LED in button  illuminates for a maximum of 10 minutes.

3. Close doors.
4. Activate the anti-theft alarm system.

To prevent false alarms, passenger compartment monitoring is deactivated if the soft top is open. The LED in button  does not illuminate.

If only the windows are open, passenger compartment monitoring operation is restricted and LED in button  illuminates.

Status message is displayed in the Driver Information Centre.

Status LED



Status LED is integrated in the sensor on top of the instrument panel.

Status during the first 30 seconds of anti-theft alarm system activation:

LED illuminates : test, arming delay
 LED flashes : doors, boot lid, soft top or bonnet not completely closed, or system fault

Status after system is armed:

LED flashes : system is armed slowly

Seek the assistance of a workshop in the event of faults.

Deactivation

Unlocking the vehicle by pressing  deactivates the anti-theft alarm system. Long press will activate soft top opening.

The system is not deactivated when unlocking the driver's door with the key or by pressing the central locking button in the passenger compartment.

Alarm

When triggered, the alarm horn sounds and the hazard warning lights flash simultaneously. The number and duration of alarm signals are stipulated by legislation.

The alarm can be silenced by pressing any button on the radio remote control or by switching on the ignition.

The anti-theft alarm system can be deactivated only by pressing  or by switching on the ignition.

A triggered alarm, which has not been interrupted by the driver, will be indicated by the hazard warning lights. They will flash quickly three times the next time the vehicle is unlocked with the radio remote control. Additionally, a warning message is displayed in the Driver Information Centre after switching on the ignition.

Vehicle messages ⇨ 103.

If the vehicle's battery is to be disconnected (e.g. for maintenance work), the alarm siren must be deactivated as follows: Switch the

ignition on then off, then disconnect the vehicle's battery within 15 seconds.

Immobiliser

The system is part of the ignition switch and checks whether the vehicle is allowed to be started with the key being used.



The immobiliser is activated automatically after the key has been removed from the ignition switch.

If the control indicator  flashes when the ignition is on, there is a fault in the system; the engine cannot be started. Switch off the ignition and repeat the start attempt.

If the control indicator continues flashing, attempt to start the engine using the spare key and seek the assistance of a workshop.

Note

The immobiliser does not lock the doors. You should always lock the vehicle after leaving it.

Switch on the anti-theft alarm system  23,  28.

Control indicator   95.

Exterior mirrors

Convex shape

The shape of the mirror makes objects appear smaller, which will affect the ability to estimate distances.

Side blind spot alert  172.

Electric adjustment

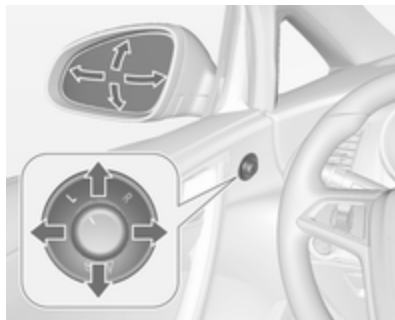

Select the relevant exterior mirror by turning the control to left (**L**) or right (**R**). Then swivel the control to adjust the mirror.

In position **0** no mirror is selected.

Folding mirrors



For pedestrian safety, the exterior mirrors will swing out of their normal mounting position if they are struck with sufficient force. Reposition the mirror by applying slight pressure to the mirror housing.

Electric folding

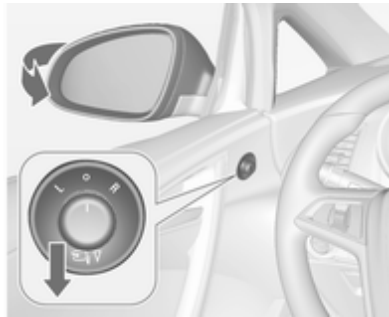

Turn control to 0, then push the control down. Both exterior mirrors will fold.

Push the control down again - both exterior mirrors return to their original position.

If an electrically folded mirror is manually extended, pressing down the control will only electrically extend the other mirror.

Heated mirrors



Operated by pressing .

The LED in the button indicates activation.

Heating works with the engine running and is switched off automatically after a short time.

Interior mirrors

Manual anti-dazzle

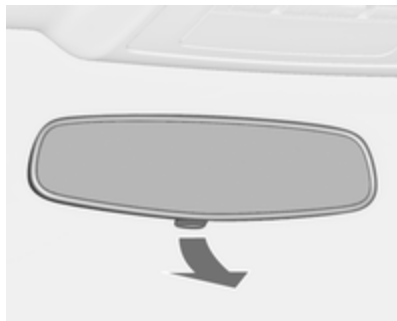

To reduce dazzle, adjust the lever on the underside of the mirror housing.

Automatic anti-dazzle



Dazzle from following vehicles at night is automatically reduced.

Windows

Windscreen

Heat-reflecting windscreen

The heat-reflecting windscreen has a coating which reflects solar radiation. Also data signals, e.g. from toll stations, might be reflected.



The marked areas on the windscreen are not covered with the coating. Devices for electronic data recording and fee payment must be attached in these areas. Otherwise data recording malfunctions may occur.

Windscreen stickers

Do not attach stickers such as toll road stickers or similar on the windscreen in the area of the interior mirror. Otherwise the detection zone of the sensor and the view area of the camera in the mirror housing could be restricted.

Windscreen replacement

Caution

If the vehicle has a front-looking camera sensor for the driver assistance systems, it is very important that any windscreen replacement is performed accurately according to Opel specifications. Otherwise, these systems may not work properly and there is a risk of unexpected behaviour and/or messages from these systems.

Power windows

⚠ Warning

Take care when operating the power windows. Risk of injury, particularly to children.

Keep a close watch on the windows when closing them. Ensure that nothing becomes trapped in them as they move.

Operable with ignition switch in position **1** or **2** (ignition on) ⇨ 139.

Retained power off ⇨ 139.



Operate the switch for the respective window by pushing to open or pulling to close.

Pushing or pulling gently to the first detent: window moves up or down as long as the switch is operated.

Pushing or pulling firmly to the second detent then releasing: window moves up or down automatically with safety function enabled. To stop movement, operate the switch once more in the same direction.

Central switch



Switch in the centre console operates all windows.

Push switch  briefly to open all windows automatically.

Pull switch  briefly to close all windows automatically.

Safety function

If the window glass encounters resistance above the middle of the window during automatic closing, it is immediately stopped and opened again.

Override safety function

In the event of closing difficulties due to frost or the like, switch on the ignition, then pull the switch to the first detent and hold. The window moves up with safety function disabled. To stop movement, release the switch.

Automatic window lowering

This automatically lowers the window a small amount when the door is being opened. When the door is being closed, the window will raise fully.

Note

In cold weather conditions, ice and snow may prevent the window from lowering when the door is being opened. Free the window from ice and snow before closing the door to ensure proper window function.





If the vehicle loses power, you may need to reprogram the windows. Follow the procedure under "Initialising the power windows" below.

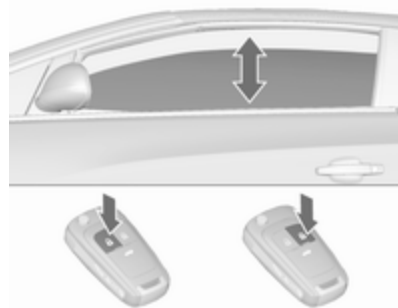

Comfort operating with the remote control

The windows and the soft top can be operated remotely from outside the vehicle.









Opening

- Press  once briefly: the doors are unlocked.
- Press  once more for two seconds: the windows move down automatically. Press  longer: the soft top will be opened. Press and hold  until soft top is completely opened.

Release  during opening of the soft top: movement stops for 10 seconds; pressing  once more continues opening.

Closing

- Press  once briefly: the doors are locked.

- Press  once more for longer: the soft top and the windows will be closed. Press and hold  until soft top is completely closed. Release  during closing of the soft top: movement stops for 10 seconds; pressing  once more continues closing.
- If the soft top is already closed but windows are opened: pressing  for two seconds will close the windows.

Confirmation

Completed opening or closing of the soft top is confirmed by the hazard warning flashers.

Overload

If the windows are repeatedly operated within short intervals, the window operation is disabled for some time.

Initialising the power windows

If the windows cannot be closed automatically (e.g. after disconnecting the vehicle battery), a warning message is displayed in the Driver Information Centre.

Vehicle messages ⇨ 103.

Activate the window electronics for each window, beginning with the rear windows, as follows:

1. Soft top must be closed.
2. Close doors.
3. Switch on ignition.
4. Pull switch to the second detent until the window starts to close, and hold for an additional 4 seconds.
5. Push switch to the second detent until the window starts to open automatically.
6. Repeat for each window.

Heated rear window



Operated by pressing .

The LED in the button indicates activation.

Heating works with the engine running and is switched off automatically after a short time.

Heated rear window is deactivated when the soft top is opened.

Sun visors

The sun visors can be folded down or swivelled to the side to prevent dazzling.

The cover of the mirrors should be closed when driving.

A ticket holder is located on the backside of the sun visor.

Roof

Soft top

⚠ Warning

Take care when operating the soft top. Risk of injury. Monitor the action zone above, to the side and to the rear of the vehicle during operation.

Make sure that no body parts or objects could get pinched. Make sure that people stay clear of the action zone of the soft top or soft top lid. Risk of injury.

Check the height, length and width of the available space before operating the soft top, e.g. in a garage, parking garage or when a bicycle rack is fitted.

Vehicle passengers should be informed accordingly.

Before leaving the vehicle, remove the ignition key in order to prevent unauthorised operation of the windows and the soft top.

Operation with the switch in the centre console

Operable with ignition switch in position 1 or 2 (ignition on) ⇨ 139.

The soft top can be opened and closed while driving up to a speed of 50 km/h.

Open soft top



Hold switch pulled until the soft top is completely opened and the soft top lid is closed. All windows will be opened during this operation.

To close all windows pull switch .

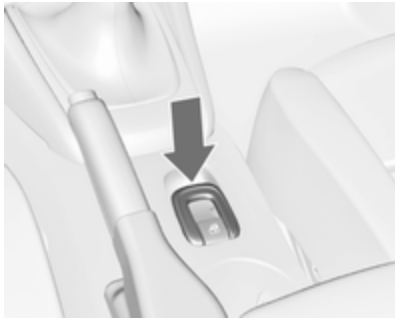
Close soft top

Hold switch pushed until the soft top and the soft top lid are completely closed. All windows will be opened during this operation.

Pull switch  briefly to close all windows.

Confirmation of operation

Complete opening or closing of the soft top with the switch in the centre console is confirmed by the sound of an acoustic signal.

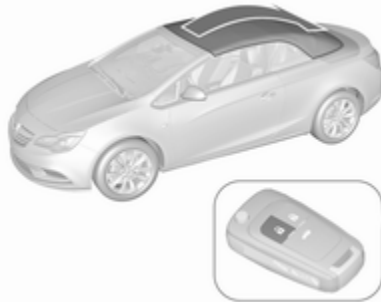
Operation with remote control**Open soft top**

Press and hold  until the soft top is opened completely and the soft top lid is closed. All windows will be opened during this operation.

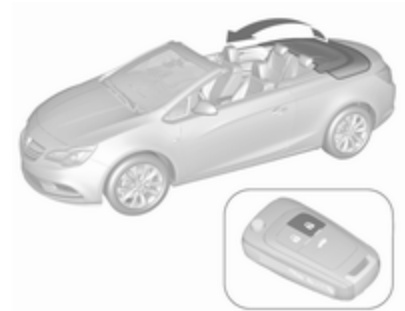
Close soft top

Press and hold  until the soft top, the soft top lid and the windows are completely closed. All windows will be opened at first during this operation.

Confirmation of operation

Complete opening or closing of the soft top with the remote control is confirmed by the hazard warning flashers.

Safety stop

The button on the remote control or the switch in the centre console must be actuated until the soft top is in its respective end position. Releasing the button or the switch during operation stops soft top movement immediately. The soft top remains in intermediate position only for a certain time. After this time a warning chime sounds, the hydraulic pressure in the system decreases and the soft top can start to move by itself. Actuating button or switch once more continues operation.

Requirements for operation

- Vehicle is stationary or driving with a speed up to 50 km/h.

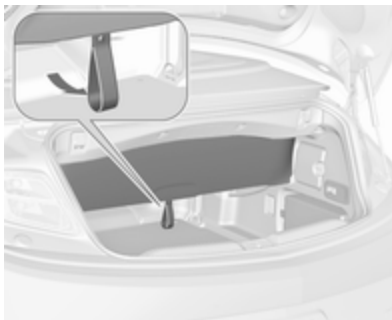

- Load compartment partition is folded out, pass-through flap is closed ↻ 73.
- Soft top lid is engaged in closed position.
- Boot lid is completely closed.
- Outside temperature is not lower than -7 °C for opening and -10 °C for closing.
- Vehicle battery voltage is sufficient.
- The system is not overloaded by repeated operation (max. 5 complete cycles in succession).

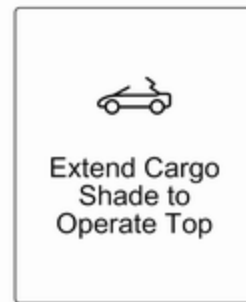

If any of these requirements are not fulfilled, a warning chime sounds and a message appears in the Driver Information Centre when the switch is actuated and the soft top will not open or close.

- There must be no objects in front of the rear window or in the pivot area of the soft top and the soft top lid.

If the automatic drive is not operational when the soft top is open, execute a manual closing process, see the following instructions in "Manual closing in the event of a system fault".

General hints

Note

- Always actuate the operation switch until the acoustic signal sounds or the hazard warning flashers illuminate, to ensure that the soft top is completely opened or closed.
- The soft top can be held in an intermediate position to facilitate cleaning of hood spaces and gaskets. Release the switch in the centre console during operation to stop soft top movement in intermediate position for a maximum of 7 minutes when ignition is on. After this time a warning chime sounds, the hydraulic pressure in the system decreases and the soft top can start to move by itself.
- Do not open the soft top if it is wet, frozen or dirty.
- Activating the soft top on uneven ground can lead to malfunctions and damage.
- Vehicle care ⇨ 232.

Manual closing in the event of a system fault

In case of malfunction of the electro-hydraulic actuation, the opened soft top can be closed manually.

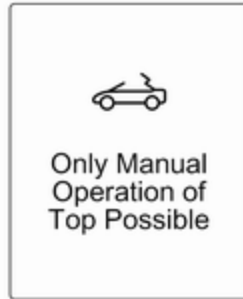

A warning chime sounds and a message appears in the Driver Information Centre.

Caution

We strongly advise performing manual closing of the soft top with two persons.

Manual operation of the soft top is permitted only for closing.

Read the following description completely before starting to operate.

Do not perform the manual closing with the vehicle parked on downhill gradient or inclines.

Remove the large wind deflector before starting to operate.

After closing, have the soft top repaired by a workshop.

Prepare the following tools which are required for manual operation:

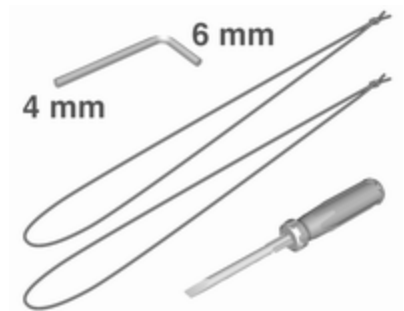

- allen key with 4 mm hexagon on the long side and 6 mm hexagon on the short side, located in the glovebox
 - two strings, located in the glovebox
 - screwdriver, located in the tool box in the load compartment
 ↳ 212
1. Switch off ignition.
 2. Open the boot lid and remove the screwdriver from the tool box.



3. On the inside of the upper load compartment edge is a lever for releasing the soft top lid. Locate the lever and unlatch by swivelling the lever downwards.

Note

The boot lid cannot be opened from next step on.

Remove the screwdriver from the toolbox for further operation. It is possible that the load compartment cannot be opened until the vehicle is at a workshop. Therefore remove any required objects from the load compartment.

4. Close boot lid.

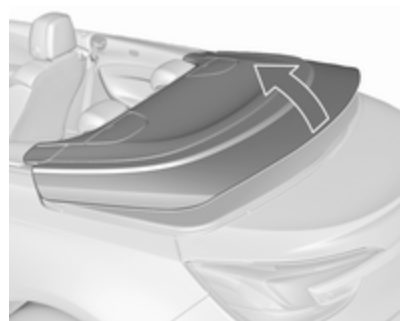

5. Lift up soft top lid from both sides simultaneously up to approx. the half raised position.

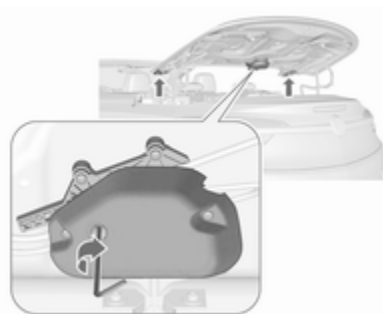

6. Insert the 4 mm Allen key into the marked position of the flap-drive unit. Turn the Allen key clockwise all the way to the stop, so that the sideways flaps are swivelled in.
7. Open the soft top lid to its end position.

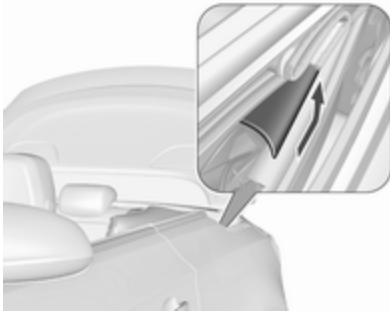

8. Remove plastic covers on both sides by pushing and sliding backwards, see illustration.



9. At the hinges on each side there are visible marks.

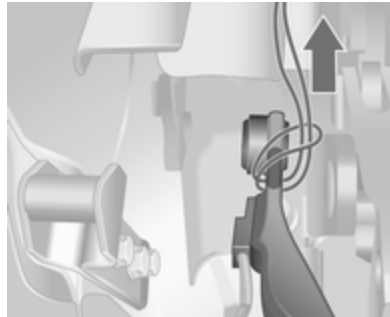

10. Haul in the attached strings around the marked position at the hinge on both sides and pull the end of the string through the loop, as shown in the illustration.

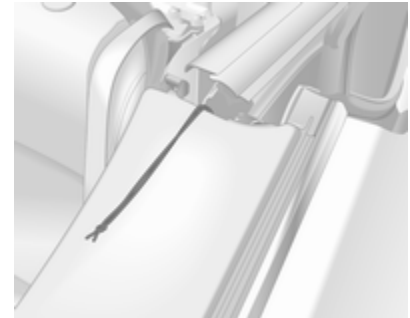

11. Deposit the end of the strings at the front.



12. Pull out the soft top by lifting up the front bow (1) and simultaneously the tension bow (2) on both sides.

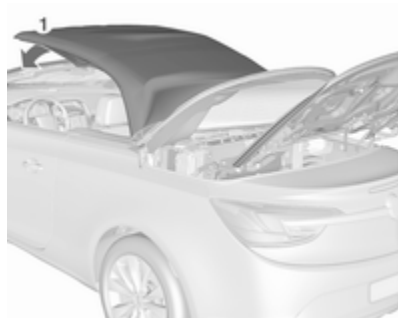

13. Move the front bow (1) to the windscreen frame.

14. Remove the small lid in the windscreen frame trim using a screwdriver which is inserted in the recess of the lid.

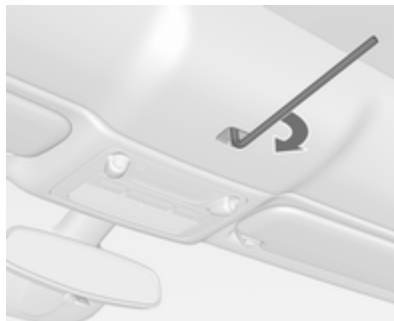

15. Insert the 6 mm Allen key into the closure and lock the latch by turning the Allen key clockwise to its end position.

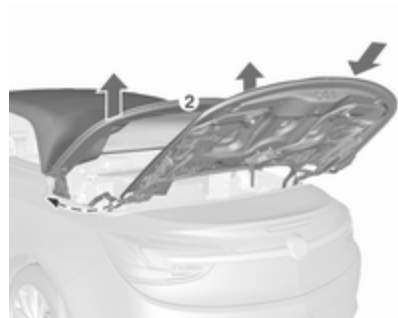

16. Lift up the tension bow (2) of the soft top on both sides. Raise up soft top lid by pushing slowly approx. to the half raised position and then let it slide into the closed position.
17. Lower the tension bow (2) of the soft top.

Note

In this position, the vehicle can be driven to a workshop for soft top overhaul. The soft top is not completely waterproof and not latched at the rear.

To latch the soft top completely, execute the following step.

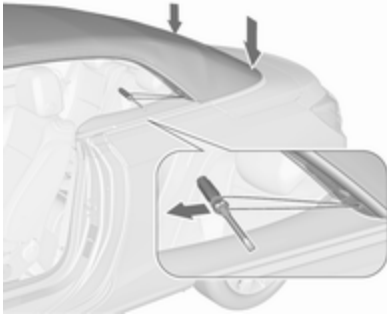

18. Push down firmly each side of the tension bow. Simultaneously pull the string with a screwdriver cross in the loop slowly and continuous to the front. Possibly support yourself on the door frame with the other hand. Execute this on both sides to latch the soft top at the rear.

After the last step, the boot lid can be opened again. Allow the strings to be removed by your workshop.

The soft top may not be opened with fixed strings.

Wind deflector

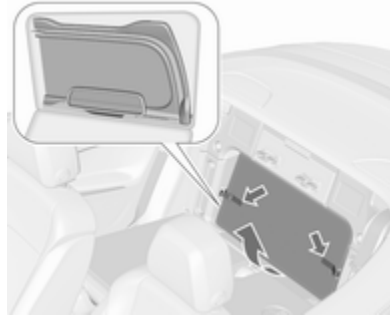

There are two wind deflectors located in a bag behind the rear seat backrests. Fold down the rear backrests ↻ 73, open the Velcro fasteners and move out the bag from the recess.

- The small wind deflector can be placed between the rear head restraints.
- The big wind deflector can be placed behind the front seats.

Do not place any objects on the wind deflector.

To install the deflectors, the soft top should be opened.

Fitting of the small wind deflector

- Fold down left rear backrest ↻ 73.



- Remove the cover from the guidance between the rear head restraints by sliding sideways to the left vehicle side.

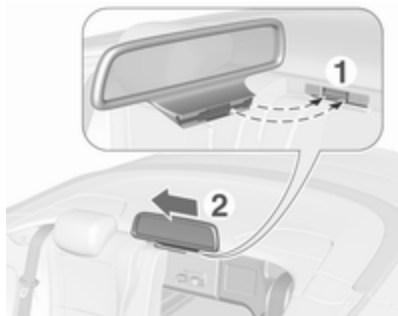

- Insert the adapter of the deflector with the elevation into the opposite recess of the guidance.
- Slide deflector in the guidance to the right vehicle side until it engages.
- Raise rear backrest.

Remove deflector in reverse order.

Fitting of the big wind deflector

- Take the deflector out of the bag.

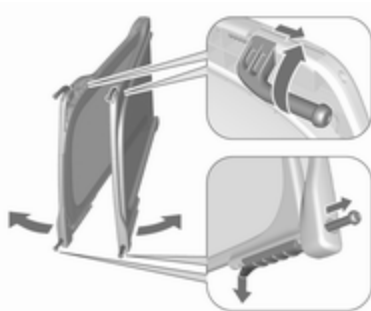

- Extract the four locking pins of the deflector: the upper ones leap out spring-loaded by turning the pins out of the brackets on both sides, the lower ones leap out by lifting the detents at the sliders on both sides.
- Expand the wind deflector.

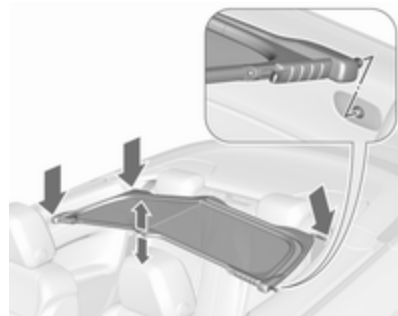

- With the hinges behind the front seats insert the right side locking pins in the recesses of the right side trim near the rear seat. Fold the deflector a little at the centre and insert the left side locking pins in the recesses of the left side trim. Ensure that all pins are properly engaged. Push down the deflector at the centre.

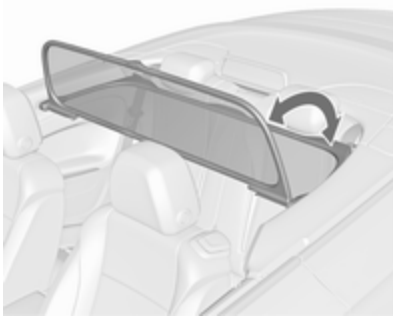

- Fold up the upper part to vertical position.

The rear seats cannot be occupied when the big wind deflector is mounted.

The vertical part of the deflector can be folded down when not used.

Wind deflector may remain mounted when the soft top is closed.

For removing fold down vertical part of the deflector. Lift up the deflector at the centre a little and remove it from the recesses on both sides.

Stowing the wind deflector

To stow the deflector, move in the rear locking pins by pushing back and turning the pins into the brackets. Push back the sliders of the front locking pins until they engage. Swing in the deflector and stow it in the bag.

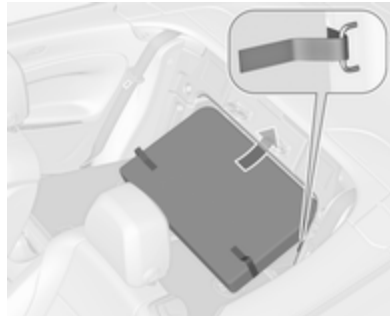

Fold down the rear backrests. Align the hard cover of the bag to the load compartment. Position the bag from the bottom up at the lateral guide in the recess of the upper frame. Fix the bag with the Velcro fastener at the lashing eyes on both sides. Raise rear backrests.

Rollover protection system

The rollover protection system consists of a reinforced windscreen frame and roll bars under covers behind the rear head restraints.

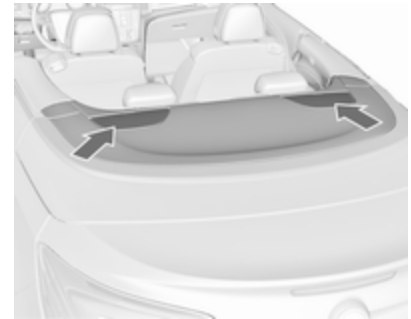

In the event of a vehicle rollover, head-on collision or side impact, the roll bars deploy upwards automatically within milliseconds. They also deploy together with the front and side airbag systems.

Note

Do not place any objects on the covers of the roll bars behind the head restraints.

The airbag control indicator  illuminates if the roll bars have been deployed.

The system deploys with the soft top opened or closed.

The soft top must not be operated if the roll bars have been deployed. A continuous warning will sound and a message appears in the Driver Information Centre if the switch is actuated.

Seats, restraints

Head restraints	47
Active head restraints	48
Front seats	49
Seat position	49
Manual seat adjustment	50
Seat folding	52
Power seat adjustment	53
Armrest	55
Heating	55
Ventilating	55
Seat belts	56
Three-point seat belt	57
Airbag system	59
Front airbag system	62
Side airbag system	63
Airbag deactivation	63
Child restraints	65
Child restraint systems	65
Child restraint installation locations	67

Head restraints

Position

⚠ Warning

Only drive with the head restraint set to the proper position.



The upper edge of the head restraint should be at upper head level. If this is not possible for extremely tall people, set to highest position, and set to lowest position for small people.

Adjustment

Head restraints on front seats



Height adjustment

Press release button, adjust height, engage.

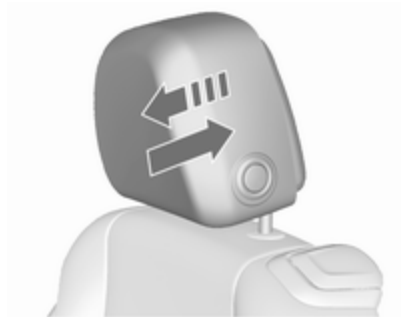
Horizontal adjustment

Pull bolster of head restraint forwards slowly. It engages in several positions.

To return to its rearmost position, pull fully forwards and release.

Head restraints on rear seats**Height adjustment**

Pull the head restraint upwards and let engage. To move downwards, press the catch to release and push the head restraint downwards.

Removal of rear head restraint

E.g. when using a child restraint system ↪ 65.

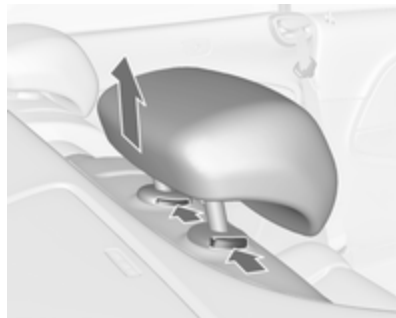

Press both catches, pull the head restraint upwards and remove.

Place the head restraint in a net bag and secure the underside of the bag with the Velcro fasteners on the load compartment floor. A suitable net bag is available at your workshop.

Active head restraints

In the event of a rear-end impact, the front parts of the active head restraints are moved slightly forwards. Thus the head is supported so that the risk of whiplash injury is reduced.

Note

Approved accessories may only be attached if the seat is not in use.

Front seats**Seat position****⚠ Warning**

Only drive with the seat correctly adjusted.

⚠ Danger

Do not sit closer than 25 cm to the steering wheel, to permit safe airbag deployment.

⚠ Warning

Never adjust seats while driving as they could move uncontrollably.

⚠ Warning

Never store any objects under the seats.



- Sit with buttocks as far back against the backrest as possible. Adjust the distance between the seat and the pedals so that legs are slightly angled when pressing the pedals. Slide the front passenger seat as far back as possible.
- Set seat height high enough to have a clear field of vision on all sides and of all display instruments. There should be at least one hand of clearance between head and the roof frame. Your thighs should rest lightly on the seat without pressing into it.

- Sit with shoulders as far back against the backrest as possible. Set the backrest rake so that it is possible to easily reach the steering wheel with arms slightly bent. Maintain contact between shoulders and the backrest when turning the steering wheel. Do not angle the backrest too far back. We recommend a maximum rake of approx. 25°.
- Adjust seat and steering wheel in a way that the wrist rests on top of the steering wheel while the arm is fully extended and shoulders on the backrest.
- Adjust the steering wheel ⇨ 79.
- Adjust the head restraint ⇨ 47.
- Adjust the thigh support so that there is a space approx. two fingers wide between the edge of the seat and the hollow of the knee.
- Adjust the lumbar support so that it supports the natural shape of the spine.

Manual seat adjustment

Drive only with engaged seats and backrests.

Longitudinal adjustment



Pull handle, slide seat, release handle. Try to move the seat back and forth to ensure that the seat is locked in place.

Backrest inclination

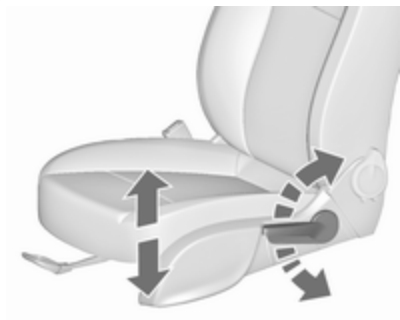

Turn lever to the rear, adjust inclination and release lever. Allow the backrest to engage audibly.

Seat height

Lever pumping motion

up : seat higher
down : seat lower

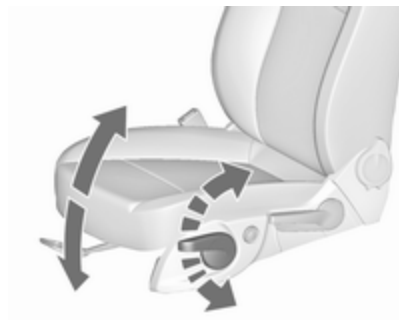
Seat inclination

Lever pumping motion

up : front end higher
down : front end lower

Lumbar support

Adjust lumbar support using the four-way switch to suit personal requirements.

Moving support up and down: push switch up or down.

Increasing and decreasing support: push switch forwards or backwards.

Adjustable thigh support

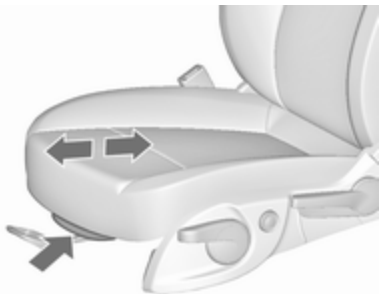

Pull the lever and slide the thigh support.

Seat folding

⚠ Warning

Passengers on rear seats should take care not to be trapped by the adjustment mechanism when the seat moves back to its original position.

Caution

When seat height is in highest position, push head restraints down and lift up sun visors before folding backrest forwards.

Seat folding on manual operated seats



Lift release lever and fold backrest forwards, then slide seat forwards to the stop.

To restore, slide the seat backwards to the stop. Lift backrest to upright position without operating any lever. Ensure backrest engages.

⚠ Warning

When folding up, ensure that the seat is securely locked in position before driving. Failure to do so may result in personal injury in the event of hard braking or collision.

When fully engaged the seat will be in original position again.

Do not operate backrest inclination lever while backrest is folded forward.

Seat folding on power seats



Lift release lever and fold backrest forwards. The seat slides automatically forwards to the stop.

To restore, lift backrest to upright position and engage. The seat slides automatically backwards to the original position.

In case the head restraint of the folded backrest is blocked by the upper windscreen frame, allow the seat to move backwards or downwards slightly ↻ 53, or set head restraint to lowest position ↻ 47.

Safety function

If the power seat encounters resistance while sliding forwards or rearwards, it is immediately stopped and moved in the opposite direction.

Note

Do not sit on the seat while seat is moving.

Power disconnection

If seat remains in forward position with opened door for more than 10 minutes, power adjustment is

disconnected. In this event, close and open the door or switch on ignition and operate power adjustment again.

Overload

If the folding function is electrically overloaded, the power supply is automatically cut-off for a short time.

Power seat adjustment

⚠ Warning

Care must be taken when operating the power seats. There is a risk of injury, particularly for children. Objects could become trapped.

Keep a close watch on the seats when adjusting them. Vehicle passengers should be informed accordingly.

Longitudinal adjustment



Move switch forwards/backwards.

Seat height



Move switch upwards/downwards.

Seat inclination



Move front of switch upwards/downwards.

Backrest inclination



Turn switch forwards/backwards.

Lumbar support



Adjust lumbar support using the four-way switch to suit personal requirements.

Moving support up and down: push switch up or down.

Increasing and decreasing support: push switch forwards or backwards.

Note

If the seat setting is electrically overloaded, the power supply is automatically cut-off for a short time.

Adjustable thigh support

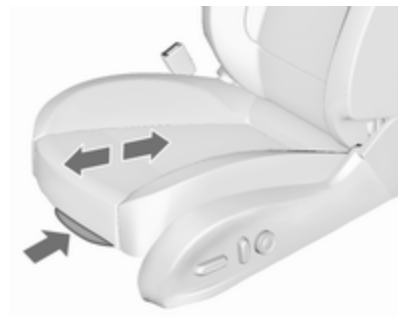

Pull the lever and slide the thigh support.

Armrest

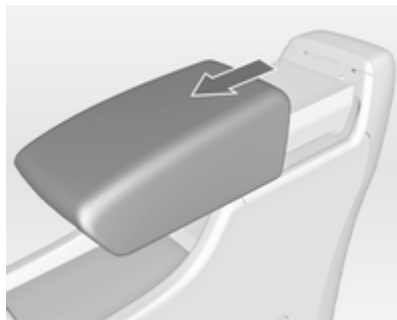

The armrest can be slid forwards by 10 cm. Under the armrest there is a storage compartment.

Armrest storage ↗ 72.

Heating



Adjust heating to the desired setting by pressing  for the respective seat one or more times. The lighting LEDs in the button indicate the setting.

Prolonged use of the highest setting for people with sensitive skin is not recommended.

Seat heating is operational when engine is running.

Seat heating is also operational during an Autostop.

Stop-start system ↗ 140.

Ventilating



Adjust ventilation to the desired setting by pressing  for the respective seat one or more times.

The lighting LEDs in the button indicate the setting.

Ventilated seats are operational with ignition on.

Seat ventilation is also operational during an Autostop.

Stop-start system ↗ 140.

Seat belts



The seat belts are locked during hard acceleration or deceleration of the vehicle holding the occupants in the seat position. Therefore the risk of injury is considerably reduced.

Warning

Fasten seat belt before each trip.

In the event of an accident, people not wearing seat belts endanger their fellow occupants and themselves.

Seat belts are designed to be used by only one person at a time. Child restraint system ⇨ 65.

Periodically check all parts of the belt system for damage, soiling and proper functionality.

Have damaged components replaced by a workshop. After an accident, have the belts and triggered belt pretensioners replaced by a workshop.

Note

Make sure that the belts are not damaged by shoes or sharp-edged objects or trapped. Prevent dirt from getting into the belt retractors.

Seat belt presenter

The seat belt presenter is a comfort feature that enables the front passengers to fasten the seat belts conveniently by bringing the belts to the front.



The presenter comes out when:

- The respective door is closed and ignition is switched on.
- The ignition is on and the door is closed.



The presenter retracts when:

- The respective door is opened again.
- The key is removed from ignition switch.
- The respective latch plate is inserted into the buckle.

- A timeout of 45 seconds elapsed.
- The vehicle is driven longer than 15 seconds with a speed of more than 6 km/h.

If the seat belt presenter does not retract automatically, push it back slightly.

Seat belt reminder

Front seats are equipped with a seat belt reminder, indicated for the driver seat as control indicator  in the tachometer  91 and for the passenger seat in the centre console  88.

Seat belt force limiters



On all seats, stress on the body is reduced by the gradual release of the belt during a collision.

Seat belt pretensioners

In the event of a head-on or rear-end collision of a certain severity, all seat belts are tightened.

Warning

Incorrect handling (e.g. removal or fitting of belts) can trigger the belt pretensioners.

Deployment of the belt pretensioners is indicated by continuous illumination of control indicator   91.

Triggered belt pretensioners must be replaced by a workshop. Belt pretensioners can only be triggered once.

Note

Do not affix or install accessories or other objects that may interfere with the operation of the belt pretensioners. Do not make any modifications to belt pretensioner components as this will invalidate the operating permit of your vehicle.

Three-point seat belt

Fasten



Withdraw the belt from the retractor, guide it untwisted across the body and insert the latch plate into the buckle. Tighten the lap belt regularly whilst driving by pulling the shoulder belt.

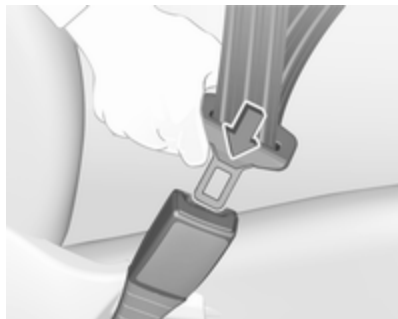

Loose or bulky clothing prevents the belt from fitting snugly. Do not place objects such as handbags or mobile phones between the belt and your body.

⚠ Warning

The belt must not rest against hard or fragile objects in the pockets of your clothing.

Seat belt reminder   91.

Unfasten



To release belt, press red button on belt buckle.

Using the seat belt while pregnant



⚠ Warning

The lap belt must be positioned as low as possible across the pelvis to prevent pressure on the abdomen.

Airbag system

The airbag system consists of a number of individual systems depending on the scope of equipment.

When triggered, the airbags inflate within milliseconds. They also deflate so quickly that it is often unnoticeable during the collision.

⚠ Warning

The airbag system deploys in an explosive manner, repairs must be performed by skilled personnel only.

⚠ Warning

Adding accessories that change the vehicle's frame, bumper system, height, front end or side sheet metal, may keep the airbag system from working properly. The operation of the airbag system can also be affected by changing any parts of the front seats, seat belts,

airbag sensing and diagnostic module, steering wheel, instrument panel, inner door seals including the speakers, any of the airbag modules, ceiling or pillar trim, front sensors, side impact sensors or airbag wiring.

Note

The airbag systems and belt pretensioner control electronics are located in the centre console area. Do not put any magnetic objects in this area.

Do not affix any objects onto the airbag covers and do not cover them with other materials. Have damaged covers replaced by a workshop.



Each airbag is triggered only once. Have deployed airbags replaced by a workshop. Furthermore, it may be necessary to have the steering wheel, the instrument panel, parts of the panelling, the door seals, handles and the seats replaced.

Do not make any modifications to the airbag system as this will invalidate the vehicle operating permit.

Fault

If there is a fault in the airbag system the control indicator  illuminates and a message or a warning code appears in the Driver Information Centre. The system is not operational.

Have the cause of the fault remedied by a workshop.

Control indicator  for airbag systems  91.

Child restraint systems on front passenger seat with airbag systems

Warning according to ECE R94.02:



EN: NEVER use a rearward-facing child restraint on a seat protected by an ACTIVE AIRBAG in front of it, DEATH or SERIOUS INJURY to the CHILD can occur.

DE: Nach hinten gerichtete Kindersitze NIEMALS auf einem Sitz verwenden, der durch einen davor befindlichen AKTIVEN AIRBAG geschützt ist, da dies den TOD oder SCHWERE VERLETZUNGEN DES KINDES zur Folge haben kann.

FR: NE JAMAIS utiliser un siège d'enfant orienté vers l'arrière sur un siège protégé par un COUSSIN GONFLABLE ACTIF placé devant lui, sous peine d'infliger des BLESSURES GRAVES, voire MORTELLES à l'ENFANT.

ES: NUNCA utilice un sistema de retención infantil orientado hacia atrás en un asiento protegido por un AIRBAG FRONTAL ACTIVO. Peligro de MUERTE o LESIONES GRAVES para el NIÑO.

RU: ЗАПРЕЩАЕТСЯ устанавливать детское удерживающее устройство лицом назад на сиденье автомобиля,

оборудованном фронтальной подушкой безопасности, если ПОДУШКА НЕ ОТКЛЮЧЕНА! Это может привести к СМЕРТИ или СЕРЬЕЗНЫМ ТРАВМАМ РЕБЕНКА.

NL: Gebruik NOOIT een achterwaarts gericht kinderzitje op een stoel met een ACTIEVE AIRBAG ervoor, om DODELIJK of ERNSTIG LETSEL van het KIND te voorkomen.

DA: Brug ALDRIG en bagudvendt autostol på et forsæde med AKTIV AIRBAG, BARNET kan komme i LIVSFARE eller komme ALVORLIGT TIL SKADE.

SV: Använd ALDRIG en bakåtvänd barnstol på ett säte som skyddas med en framförvarande AKTIV AIRBAG. DÖDSFALL eller ALLVARLIGA SKADOR kan drabba BARNET.

FI: ÄLÄ KOSKAAN sijoita taaksepäin suunnattua lasten turvaistuinta istuimelle, jonka edessä on AKTIIVINEN TURVATYYNYY, LAPSI VOI KUOLLA tai VAMMAUTUA VAKAVASTI.

NO: Bakovervendt barnesikringsutstyr må ALDRI brukes på et sete med AKTIV KOLLISJONSPUTE foran, da det kan føre til at BARNET utsettes for LIVSFARE og fare for ALVORLIGE SKADER.

PT: NUNCA use um sistema de retenção para crianças voltado para trás num banco protegido com um AIRBAG ACTIVO na frente do mesmo, poderá ocorrer a PERDA DE VIDA ou FERIMENTOS GRAVES na CRIANÇA.

IT: Non usare mai un sistema di sicurezza per bambini rivolto all'indietro su un sedile protetto da AIRBAG ATTIVO di fronte ad esso: pericolo di MORTE o LESIONI GRAVI per il BAMBINO!

EL: ΠΟΤΕ μη χρησιμοποιείτε παιδικό κάθισμα ασφαλείας με φορά προς τα πίσω σε κάθισμα που προστατεύεται από μετωπικό ΕΝΕΡΓΟ ΑΕΡΟΣΑΚΟ, διότι το παιδί μπορεί να υποστεί ΘΑΝΑΣΙΜΟ ή ΣΟΒΑΡΟ ΤΡΑΥΜΑΤΙΣΜΟ.

PL: NIE WOLNO montować fotelika dziecięcego zwróconego tyłem do kierunku jazdy na fotelu, przed którym znajduje się WŁĄCZONA PODUSZKA POWIETRZNA.

Niezastosowanie się do tego zalecenia może być przyczyną ŚMIERCI lub POWAŻNYCH OBRAŻEŃ u DZIECKA.

TR: Arkaya bakan bir çocuk emniyet sistemini KESİNLİKLE ölünde bir AKTİF HAVA YASTIĞI ile korunmakta olan bir koltukta kullanmayınız. ÇOCUK ÖLEBİLİR veya AĞIR ŞEKİLDE YARALANABİLİR.

UK: НИКОЛИ не використовуйте систему безпеки для дітей, що встановлюється обличчям назад, на сидінні з УВІМКНЕНОЮ ПОДУШКОЮ БЕЗПЕКИ, інакше це може призвести до СМЕРТІ чи СЕРІОЗНОГО ТРАВМУВАННЯ ДИТИНИ.

HU: SOHA ne használjon hátrafelé néző biztonsági gyerekülést előlről AKTÍV LÉGZSÁKKAL védett ülésen, mert a GYERMEK HALÁLÁT vagy KOMOLY SÉRÜLÉSÉT okozhatja.

HR: NIKADA nemojte koristiti sustav zadržavanja za djecu okrenut prema natrag na sjedalu s AKTIVNIM ZRAČNIM JASTUKOM ispred njega, to bi moglo dovesti do SMRTI ili OZBILJNIH OZLJEDA za DIJETE.

SL: NIKOLI ne nameščajte otroškega varnostnega sedeža, obrnjenega v nasprotni smeri vožnje, na sedež z AKTIVNO ČELNO ZRAČNO BLAZINO, saj pri tem obstaja nevarnost RESNIH ali SMRTNIH POŠKODB za OTROKA.

SR: NIKADA ne koristiti bezbednosni sistem za decu u kome su deca okrenuta unazad na sedištu sa AKTIVNIM VAZDUŠNIM JASTUKOM ispred sedišta zato što DECE može da NASTRADA ili da se TEŠKO POVREDI.

MK: НИКОГАШ не користете детско седиште свртено наназад на седиште заштитено со АКТИВНО ВОЗДУШНО ПЕРНИЧЕ пред него, зато што детето може ДА ЗАГИНЕ или да биде ТЕШКО ПОВРЕДЕНО.

BG: НИКОГА не използвайте детска седалка, гледаща назад, върху седалка, която е защитена

чрез АКТИВНА ВЪЗДУШНА ВЪЗГЛАВНИЦА пред нея - може да се стигне до СМЪРТ или СЕРИОЗНО НАРАНЯВАНЕ на ДЕТЕТО.

RO: Nu utilizați NICIODATĂ un scaun pentru copil îndreptat spre partea din spate a mașinii pe un scaun protejat de un AIRBAG ACTIV în fața sa; acest lucru poate duce la DECESUL sau VĂTĂMAREA GRAVĂ a COPILULUI.

CS: NIKDY nepoužívejte dětský zádržný systém instalovaný proti směru jízdy na sedadle, které je chráněno před sedadlem AKTIVNÍM AIRBAGEM. Mohlo by dojít k VÁŽNÉMU PORANĚNÍ nebo ÚMRTÍ DÍTĚTE.

SK: NIKDY nepoužívajte detskú sedačku otočenú vzad na sedadle chránenom AKTÍVNÝM AIRBAGOM, pretože môže dôjsť k SMRTI alebo VÁŽNÝM ZRANENIAM DIEŤAŤA.

LT: JOKIU BŪDU nemontuokite atgal atgręžtos vaiko tvirtinimo sistemas sėdynėje, prieš kurią įrengta AKTYVI ORO PAGALVĖ, nes VAIKAS GALI ŽŪTI arba RIMTAI SUSIŽALOTI.

LV: NEKĀDĀ GADĪJUMĀ neizmantojiet uz aizmuguri vērstu bērnu sēdekļi sēdvietā, kas tiek aizsargāta ar tās priekšā uzstādītu AKTĪVU DROŠĪBAS SPILVENU, jo pretējā gadījumā BĒRNS var gūt SMAGAS TRAUMAS vai IET BOJĀ.

ET: ĀRGE kasutage tahapoole suunatud lapseturvaistet istmel, mille ees on AKTIIVSE TURVAPADJAGA kaitstud iste, sest see võib põhjustada LAPSE SURMA või TÕSISE VIGASTUSE.

MT: QATT tuža tražžin għat-ḥfal li jħares lejn in-naħa ta' wara fuq sit protett b' AIRBAG ATTIV quddiemu; dan jista' jikkawża l-MEWT jew GRIEHI SERJI lit-TFAL.

GA: Ná húsáid srian sábháilteachta linbh cúil RIAMH ar shuíochán a bhfuil mála aeir ag feidhmiú os a chomhair. Tá baol BÁIS nó GORTÚ DONA don PHÁISTE ag baint leis.

Beyond the warning required by ECE R94.02, for safety reasons never use a forward-facing child restraint system on the passenger seat with an active front airbag.

Danger

Do not use a child restraint system on the passenger seat with active front airbag.

The airbag label is located on both sides of the front passenger sun visor.
Airbag deactivation ⇨ 63.

Front airbag system

The front airbag system consists of one airbag in the steering wheel and one in the instrument panel on the front passenger side. These can be identified by the word **AIRBAG**.



Additionally, there is a warning label on the side of the instrument panel, visible when the front passenger door is open, or on the front passenger sun visor.

The front airbag system is triggered in the event of a front-end impact of a certain severity. The ignition must be switched on.

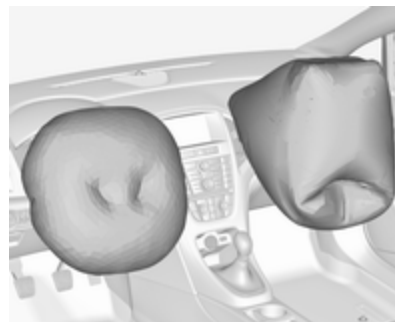

The inflated airbags cushion the impact, thereby reducing the risk of injury to the upper body and head of the front seat occupants considerably.

⚠ Warning

Optimum protection is only provided when the seat is in the proper position.

Seat position ⇨ 49.

Keep the area in which the airbag inflates clear of obstructions.

Fit the seat belt correctly and engage securely. Only then is the airbag able to protect.

Side airbag system



The side airbag system consists of an airbag in each front seat backrest. This can be identified by the word **AIRBAG**.

The side airbag system is triggered in the event of a side impact of a certain severity. The ignition must be switched on.



The inflated airbags cushion the impact, thereby reducing the risk of injury to the head and upper body in the event of a side-on collision considerably.

⚠ Warning

Keep the area in which the airbag inflates clear of obstructions.

Note

Only use protective seat covers that have been approved for the vehicle. Be careful not to cover the airbags.

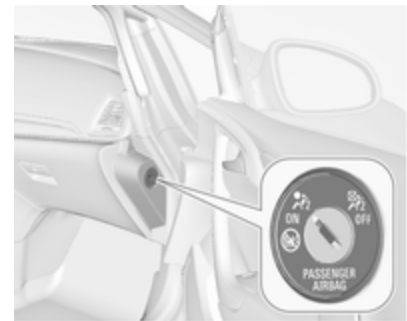

Airbag deactivation

The front passenger airbag system must be deactivated if a child restraint system is to be fitted on this seat. The side airbags, the belt pretensioners and all driver airbag systems will remain active.



The front passenger airbag system can be deactivated via a key-operated switch on the right side of the instrument panel.

Use the ignition key to choose the position:

-  OFF : front passenger airbag is deactivated and will not inflate in the event of a collision. Control indicator  OFF illuminates continuously in the centre console. A child restraint system can be installed in accordance with the chart **Child restraint installation locations** ⇨ 67. No adult person is allowed to occupy the front passenger seat.
-  ON : front passenger airbag is active. A child restraint system must not be installed.

Danger

Risk of fatal injury for a child using a child restraint system on a seat with activated front passenger airbag.

Risk of fatal injury for an adult person on a seat with deactivated front passenger airbag.



If the control indicator  illuminates, the front passenger airbag system will inflate in the event of a collision.

If both control indicators are illuminated at the same time, there is a system failure. The status of the

system is not discernible, therefore no person is allowed to occupy the front passenger seat. Contact a workshop immediately.

Change status only when the vehicle is stopped with the ignition off.

Status remains until the next change.

Control indicator for airbag deactivation ⇨ 91.

Child restraints

Child restraint systems

We recommend the following child restraint systems which are tailored specifically to the vehicle:

- **Group 0, Group 0+**
OPEL Baby cradle, with or without ISOFIX base, for children up to 13 kg
- **Group I**
OPEL Duo, Britax Römer King, for children from 9 kg to 18 kg
- **Group II, Group III**
OPEL Kid, OPEL Kidfix, for children from 15 kg up to 36 kg

When a child restraint system is being used, pay attention to the following usage and installation instructions and also those supplied with the child restraint system.

Always comply with local or national regulations. In some countries, the use of child restraint systems is forbidden on certain seats.

⚠ Warning

When using a child restraint system on the front passenger seat, the airbag systems for the front passenger seat must be deactivated; if not, the triggering of the airbags poses a risk of fatal injury to the child.

This is especially the case if rear-facing child restraint systems are used on the front passenger seat.

Airbag deactivation ⇨ 63.

Airbag label ⇨ 59.

⚠ Warning

When using child restraint systems on the rear seats, ensure that the backrests are engaged securely in upright position.

Selecting the right system

The rear seats are the most convenient location to fasten a child restraint system.

Children should travel facing rearwards in the vehicle as long as possible. This makes sure that the child's backbone, which is still very weak, is under less strain in the event of an accident.

Suitable are restraint systems that comply with valid UN ECE regulations. Check local laws and regulations for mandatory use of child restraint systems.

Ensure that the child restraint system to be installed is compatible with the vehicle type.

Ensure that the mounting location of the child restraint system within the vehicle is correct, see following tables.

Allow children to enter and exit the vehicle only on the side facing away from the traffic.

When the child restraint system is not in use, secure the seat with a seat belt or remove it from the vehicle.

Note

Do not affix anything on the child restraint systems and do not cover them with any other materials.

A child restraint system which has been subjected to stress in an accident must be replaced.

Child restraint systems can be fastened with:

- Three-point seat belt
- ISOFIX brackets
- Top-tether anchor

Three-point seat belt

Child restraint systems can be fastened by using a three-point seat belt. Depending on the size of the used child restraint systems, up to three child restraint systems can be attached to the rear seats. After fastening the child restraint system the seat belt has to be tightened ⇨ 67.

ISOFIX child restraint systems

Fasten vehicle-approved ISOFIX child restraint systems to the ISOFIX mounting brackets. Specific vehicle

ISOFIX child restraint system positions are marked in the table by IL ⇨ 67.



Remove wind deflector ⇨ 43 before mounting a child restraint system and remove rear head restraint if required ⇨ 67.

ISOFIX mounting brackets are indicated by a logo ISOFIX on the backrest.

Top-tether anchors

The vehicle has two anchors on the backside of the rear backrests.

Top-Tether anchors are marked with the symbol  for a child seat.

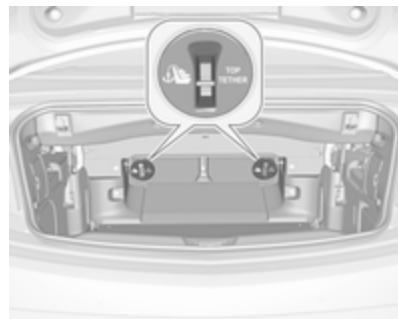

In addition to the ISOFIX mounting, fasten the Top-Tether strap to the Top-Tether anchors on the backside of the rear seats. Folding rear backrests ⇨ 73.

Remove wind deflector ⇨ 43 before mounting a child restraint system and remove rear head restraint if required ⇨ 67.

ISOFIX child restraint systems of universal category positions are marked in the table by IUF ⇨ 67.

Child restraint installation locations

Permissible options for fitting a child restraint system

Weight class	On front passenger seat		On rear seats
	activated airbag	deactivated airbag	
Group 0: up to 10 kg	X	U ¹	U
Group 0+: up to 13 kg	X	U ¹	U
Group I: 9 to 18 kg	X	U ¹	U ²
Group II: 15 to 25 kg	X	X	U
Group III: 22 to 36 kg	X	X	U

¹ : If the child restraint system is being secured using a three-point seat belt, move seat into the rear adjustment area and set seat height to uppermost position. Adjust seat backrest as far as necessary to a vertical position to ensure that the belt is tight on the buckle side.

² : Remove rear head restraint when using child restraint systems in this weight group ⇨ 47.

U : Universal suitability in conjunction with three-point seat belt.

X : No child restraint system permitted in this weight class.

Permissible options for fitting an ISOFIX child restraint system

Weight class	Size class	Fixture	On front passenger seat	On rear seats
Group 0: up to 10 kg	E	ISO/R1	X	IL *
Group 0+: up to 13 kg	E	ISO/R1	X	IL *
	D	ISO/R2	X	IL *
	C	ISO/R3	X	IL *
Group I: 9 to 18 kg	D	ISO/R2	X	IL *
	C	ISO/R3	X	IL *
	B	ISO/F2	X	IL, IUF**
	B1	ISO/F2X	X	IL, IUF**
	A	ISO/F3	X	IL, IUF**
Group II: 15 to 25 kg			X	IL
Group III: 22 to 36 kg			X	IL

IL : Suitable for particular ISOFIX restraint systems of the 'specific-vehicle', 'restricted' or 'semi-universal' categories.
The ISOFIX restraint system must be approved for the specific vehicle type.

IUF : Suitable for ISOFIX forward-facing child restraint systems of universal category approved for use in this weight class.

X : No ISOFIX child restraint system approved in this weight class.

* : Move the respective front seat ahead of the child restraint system forwards as far as necessary.

** : Remove respective rear head restraint when using child restraint systems in this size class ⇨ 47.

ISOFIX size class and seat device

- A – ISO/F3 : Forward-facing child restraint system for children of maximum size in the weight class 9 to 18 kg.
- B – ISO/F2 : Forward-facing child restraint system for smaller children in the weight class 9 to 18 kg.
- B1 – ISO/F2X : Forward-facing child restraint system for smaller children in the weight class 9 to 18 kg.
- C – ISO/R3 : Rear-facing child restraint system for children of maximum size in the weight class up to 18 kg.
- D – ISO/R2 : Rear-facing child restraint system for smaller children in the weight class up to 18 kg.
- E – ISO/R1 : Rear-facing child restraint system for young children in the weight class up to 13 kg.

Storage

Storage compartments	70
Glovebox	70
Cupholders	71
Front storage	71
Armrest storage	72
Centre console storage	72
Load compartment	73
Rear storage	75
Rear floor storage cover	75
Lashing eyes	76
Warning triangle	76
First aid kit	76
Loading information	77

Storage compartments

⚠ Warning

Do not store heavy or sharp objects in the storage compartments. Otherwise, the storage compartment lid could open and vehicle occupants could be injured by objects being thrown around in the event of hard braking, a sudden change in direction or an accident.

Glovebox



The glovebox features a pen holder, a credit card holder, a coin holder and an adapter for the locking wheel nuts.



Close glovebox whilst driving. It can be locked with the vehicle key.

Cupholders

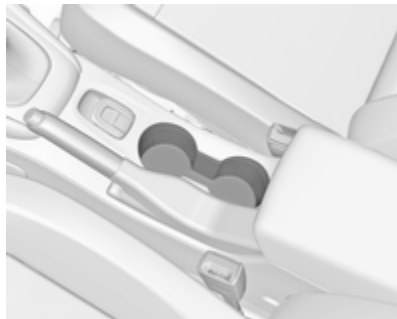

Cupholders are located in the centre console.



Depending on the version, cupholders are located under a cover in the centre console.

Slide cover backwards. Bottles can be stowed after folding up the intermediate shelf ↻ 72.



Additional cupholders are located between the rear seats.

Front storage

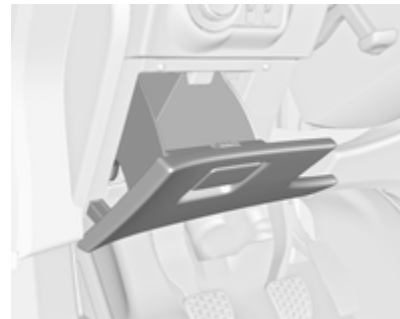

A storage compartment is located next to the steering wheel.

Armrest storage

Storage under the front armrest

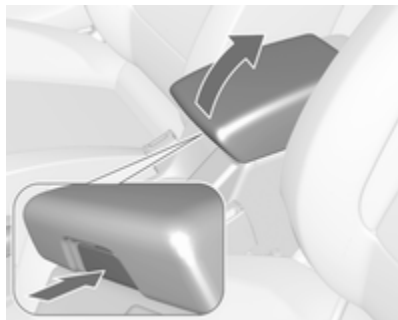

Press button to fold up the armrest. The armrest must be in rearmost position.

Centre console storage

Front console

Depending on the version, a storage compartment is located under a cover.

Slide cover backwards.



Press button to remove the frame of the cupholder. The frame can be stowed in the glovebox.

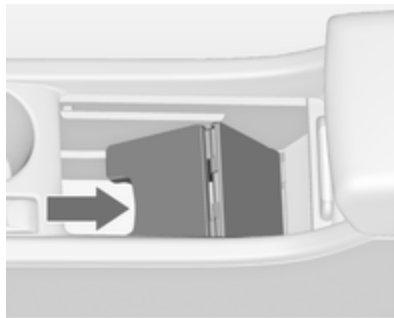

A further storage compartment is located under the intermediate shelf. Fold up the intermediate shelf and fix it in the vertical position. The frame of the cupholder can be reintegrated to stow bottles.

Rear console



Pull out the drawer.

Caution
Do not use for ashes or for other glowing items.

Load compartment

Load compartment extension

Folding load compartment partition

To enlarge the load compartment when the soft top is closed, the load compartment partition can be folded in.

- Close soft top ⇨ 36.
- Open the boot lid ⇨ 26.

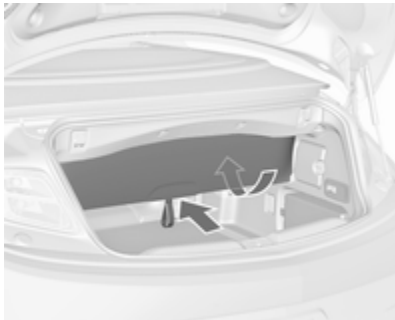

- To fold in, push the load compartment partition at the loop area upwards to the inside.



- To fold out the load compartment partition, pull the loop downwards to the rear. The pass-through flap must be closed in vertical position with the Velcro fasteners.

During soft top operation or when it is opened, the load compartment partition must be folded out.

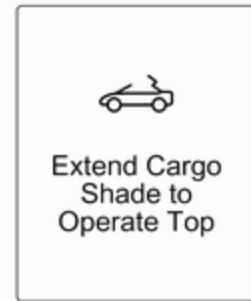

A warning chime sounds and a message appears in the Driver Information Centre if the load compartment partition is not folded out fully, including the pass-through flap behind the rear seats, when operating the switch to open the soft top.

Folding rear backrests

To enlarge load compartment further or to gain access to the wind deflector bag, both rear backrests can be folded down.

⚠ Warning

Take care when operating the electric foldable rear seats. The seat backrest is folded with considerable power. Risk of injury, particularly to children.

Ensure that nothing is attached to the rear seats or located on the seat cushion.

- Remove big wind deflector if installed ⇨ 43.
- Press the catches and push down the head restraints ⇨ 47.

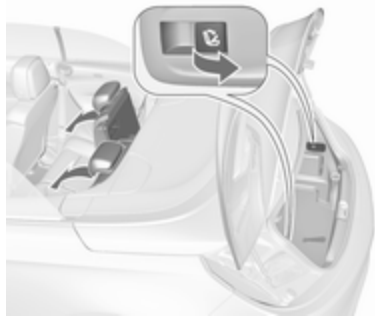

- Pull the release switch  on one or both sides of the load compartment, to fold down the backrests onto the seat cushion.
- To fold up, raise the backrest and guide it into an upright position until it engages audibly.

Caution

When loading the vehicle from the passenger compartment, fold in the load compartment partition. Otherwise the load compartment partition may be damaged.

⚠ Warning

When folding up, ensure that backrests are securely locked in position before driving. Failure to do so may result in personal injury or damage to the load or vehicle in the event of hard braking or a collision.

Pass-through flap behind rear seats

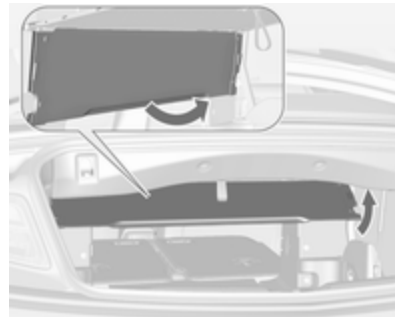

For transporting long objects in the load compartment, a pass-through flap between load compartment and vehicle interior can be opened:

- Remove the installed big wind deflector or the bag with the stowed wind deflectors behind the rear seats ⇨ 43.
- Close soft top ⇨ 36.
- Push the load compartment partition at the loop area upwards to the inside ⇨ 73.

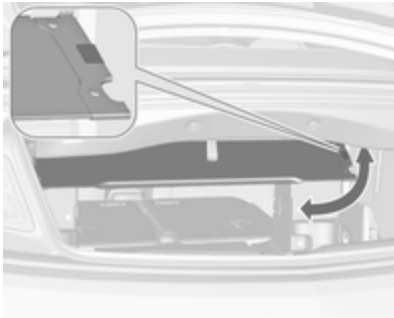

- Open the pass-through by swivelling the flap upwards to horizontal position. The flap is fixed in opened or closed position with a Velcro fastener.
- Fold down rear backrests by pulling the release switches  in the load compartment.
- To close the pass-through, swivel the flap downwards and fix it in vertical position with the Velcro fastener.

Fold out the load compartment partition by pulling the loop downwards to the rear, in order to

open the soft top. The pass-through flap must be closed in vertical position.

Rear storage

Hooks for carrier bags

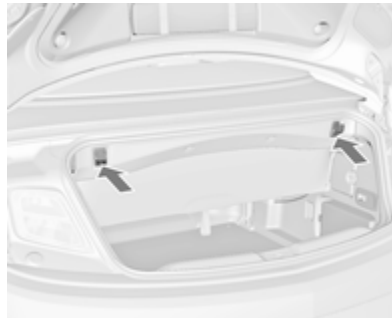

Use the hooks at the upper edge of the load compartment for hanging up carrier bags. Maximum load: 5 kg.

Rear floor storage cover

Rear floor cover

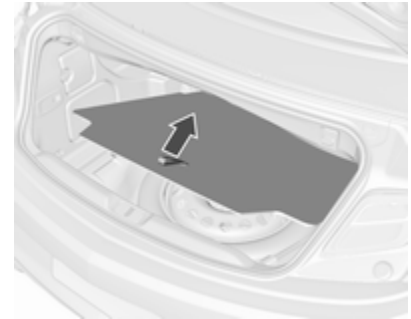

The rear floor cover can be lifted and removed. Under the cover there is the spare wheel, vehicle tools or the tyre repair kit.

Lashing eyes

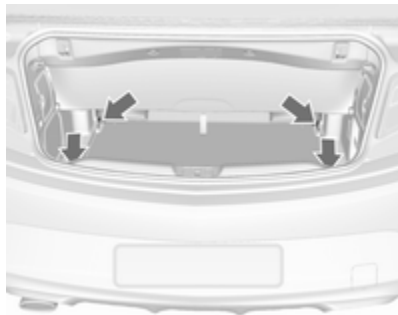

The lashing eyes are designed to secure items against slippage, e.g. using lashing straps or luggage net.

Warning triangle

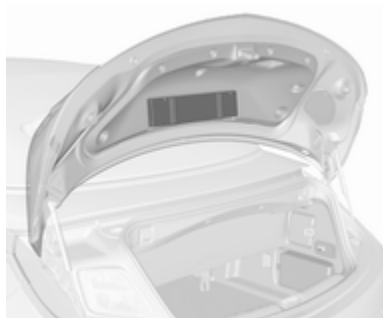

Warning triangle is stowed in the space on the inside of the boot lid behind the straps.

First aid kit



The first aid kit is stowed on the right side in the load compartment behind a strap.

Loading information

- Heavy objects in the load compartment should be placed as far forward as possible. Ensure that the backrests are securely engaged. If objects can be stacked, heavier objects should be placed at the bottom.
 - Secure objects with lashing straps attached to the lashing eyes ⇨ 76.
 - Use the hooks in the load compartment for hanging up carrier bags ⇨ 75. Maximum load: 5 kg per hook.
 - Secure loose objects in the load compartment to prevent them from sliding.
 - When transporting objects in the load compartment, the backrests of the rear seats must not be angled forward.
 - Do not place any objects on the instrument panel, and do not cover the sensor on top of the instrument panel.
- The load must not obstruct the operation of the pedals, parking brake and gear selector lever, or hinder the freedom of movement of the driver. Do not place any unsecured objects in the interior.
 - Do not place any objects on the covers of the roll bars behind the head restraints.
 - Do not drive with an open load compartment.

Warning

Always ensure that the load in the vehicle is securely stowed. Otherwise objects can be thrown around inside the vehicle and cause personal injury or damage to the load or vehicle.

- The payload is the difference between the permitted gross vehicle weight (see identification plate ⇨ 239) and the EC kerb weight.
To calculate the payload, enter the data for your vehicle in the

weights table at the front of this manual.

The EC kerb weight includes weights for the driver (68 kg), luggage (7 kg) and all fluids (fuel tank 90% full).

Optional equipment and accessories increase the kerb weight.

Instruments and controls

Controls	79
Steering wheel adjustment	79
Steering wheel controls	79
Heated steering wheel	79
Horn	80
Windscreen wiper and washer ..	80
Outside temperature	81
Clock	82
Power outlets	83
Cigarette lighter	84
Ashtrays	84
Warning lights, gauges and indicators	85
Instrument cluster	85
Speedometer	85
Odometer	85
Trip odometer	85
Tachometer	86
Fuel gauge	86
Engine coolant temperature gauge	86
Service display	87
Control indicators	88
Turn lights	90

Seat belt reminder	91
Airbag, belt tensioners and roll bars	91
Airbag deactivation	91
Charging system	91
Malfunction indicator light	92
Brake and clutch system	92
Operate pedal	92
Electric parking brake	92
Electric parking brake fault	93
Antilock brake system (ABS)	93
Upshift	93
Power steering	93
Lane departure warning	93
Electronic Stability Control off ..	94
Electronic Stability Control and Traction Control system	94
Traction Control system off	94
Preheating	94
Exhaust filter	94
AdBlue	94
Tyre pressure monitoring system	94
Engine oil pressure	95
Low fuel	95
Immobiliser	95
Exterior light	95
High beam	95
High beam assist	96
Adaptive forward lighting	96

Fog light	96
Rear fog light	96
Cruise control	96
Vehicle detected ahead	96
Door open	96
Displays	96
Driver Information Centre	96
Info Display	101
Vehicle messages	103
Warning chimes	103
Battery voltage	104
Vehicle personalisation	104
Telematics service	109
OnStar	109

Controls

Steering wheel adjustment



Unlock lever, adjust steering wheel, then engage lever and ensure it is fully locked.

Do not adjust steering wheel unless vehicle is stationary and steering wheel lock has been released.

Steering wheel controls



The Infotainment system, some driver assistance systems and a connected mobile phone can be operated via the controls on the steering wheel.

Further information is available in the Infotainment manual.

Driver assistance systems ↗ 159.

Heated steering wheel



Activate heating by pressing . Activation is indicated by the LED in the button.



The highlighted grip areas of the steering wheel are heated quicker and to a higher temperature than the other areas.

Heating is operational when the engine is running and during an Autostop.

Stop-start system ⇨ 140.

Horn



Press .

Windscreen wiper and washer

Windscreen wiper

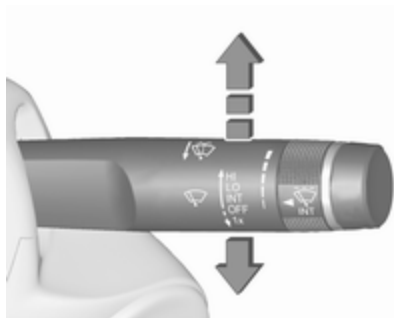

- HI** : fast
LO : slow
INT : interval wiping
 or
 automatic wiping with rain sensor
OFF : off

For a single wipe when the windscreen wiper is off, press the lever down to position **1x**.

Do not use if the windscreen is frozen.

Switch off in car washes.

Adjustable wiper interval



Wiper lever in position **INT**.

Turn the adjuster wheel to adjust the wiping frequency.

Adjustable sensitivity of the rain sensor



Wiper lever in position **INT**.

Turn the adjuster wheel to adjust the sensitivity of the rain sensor.

The rain sensor detects the amount of water on the windscreen and automatically regulates the wiping frequency and speed.

After 20 seconds without wiping activity, the wiper arms move slightly down to park position.



Keep the sensor free from dust, dirt and ice.

Windscreen and headlight washer



Pull lever. Washer fluid is sprayed onto the windscreen and the wiper wipes a few times.

If the headlights are on, washer fluid is also sprayed onto the headlights, provided that the lever is pulled sufficiently long. Afterwards, the headlight washer system is inoperable for 5 wash cycles or until engine or headlights have been switched off and on again.

Outside temperature

A drop in temperature is indicated immediately and a rise in temperature after a time delay.

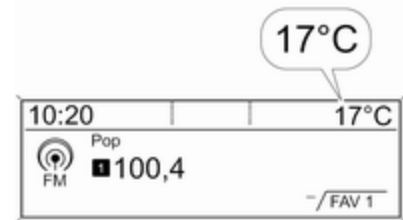

The illustration shows Graphic-Info-Display

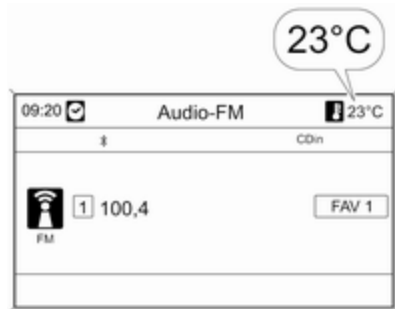

The illustration shows Colour-Info-Display



If outside temperature drops to 3 °C, a warning message is displayed in the Driver Information Centre.

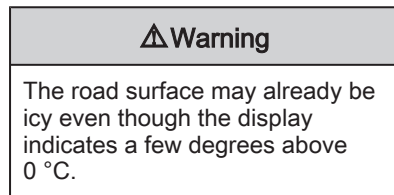

Clock

Date and time are shown in the Info-Display.

Time and date settings

CD 400plus/CD 400/CD 300

Press **CONFIG**. The menu **Settings** is displayed.

Select **Time Date**.

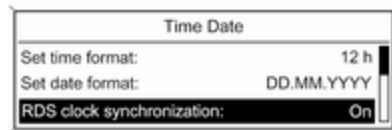

20136

Selectable setting options:

- **Set time:** Changes the time shown on the display.
- **Set date:** Changes the date shown on the display.
- **Set time format:** Changes indication of hours between 12 h and 24 h.
- **Set date format:** Changes indication of date between MM/DD/YYYY and DD.MM.YYYY.
- **Display clock:** Switches on/off indication of time on the display.
- **RDS clock synchronization:** The RDS signal of most VHF transmitters automatically sets

the time. RDS time synchronisation can take a few minutes. Some transmitters do not send a correct time signal. In such cases, it is recommended to switch off automatic time synchronisation.

Vehicle personalisation ⇨ 104.

Time and date settings

Navi 950/Navi 650/CD 600

Press **Config** then select the **Time and Date** menu item to display the respective submenu.

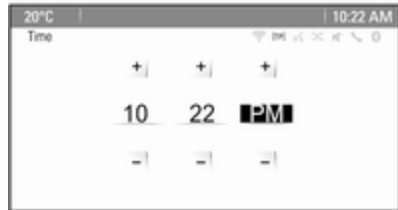

Note

If **RDS Auto Time Adjust** is activated, time and date are automatically set by the system.

See Infotainment manual for further information.

Set time

To adjust the time settings, select the **Set Time** menu item. Turn the multifunction knob to adjust the first setting.

Press the multifunction knob to confirm the input. The coloured background moves to the next setting.

Adjust all settings.

Set date

To adjust the time settings, select the **Set Date** menu item. Turn the multifunction knob to adjust the first setting.

Press the multifunction knob to confirm the input. The coloured background moves to the next setting.

Adjust all settings.

Time format

To choose the desired time format, select **12 hr / 24 hr Format**. Activate **12 Hour** or **24 Hour**.

Vehicle personalisation ⇨ 104.

Power outlets



A 12 Volt power outlet is located in the front console.



A further 12 Volt power outlet is located in the rear console. Fold the cover downwards.

Do not exceed the maximum power consumption of 120 watts.

With ignition off, the power outlets are deactivated. Additionally the power outlets are deactivated in the event of low vehicle battery voltage.

Electrical accessories that are connected must comply with the electromagnetic compatibility requirements laid down in DIN VDE 40 839.

Do not connect any current-delivering accessories, e.g. electrical charging devices or batteries.

Do not damage the outlet by using unsuitable plugs.

Stop-start system ⇨ 140.

Cigarette lighter



The cigarette lighter is located in the front console.

Press in cigarette lighter. It switches off automatically once the element is glowing. Pull out lighter.

Ashtrays

Caution

To be used only for ash and not for combustible rubbish.



The portable ashtray can be placed in the cupholders.

Warning lights, gauges and indicators

Instrument cluster

In some versions, the needles of the instruments briefly rotate to the end position when the ignition is switched on.

Speedometer



Indicates vehicle speed.

Odometer



The bottom line displays the recorded distance in km.

Trip odometer



/:∖ displays the recorded distance since the last reset.

Two trip odometer are selectable for different trips. Select between page /:∖1 and page /:∖2 by turning the adjuster wheel on turn signal lever.

Both trip odometer can be reset separately when ignition is on: select respective page, press and hold the reset knob for a few seconds or press **SET/CLR** on the turn signal lever.

Trip odometer counts up to a distance of 9,999 km and then restarts at 0.

Driver Information Centre ⇨ 96.

Tachometer



Displays the engine speed.

Drive in a low engine speed range for each gear as much as possible for fuel saving reasons.

Caution

If the needle is in the red warning zone, the maximum permitted engine speed is exceeded. Engine at risk.

Fuel gauge



Displays the fuel level in the tank.

Control indicator ● illuminates if the level in the tank is low. Refuel immediately if it flashes.

Never run the tank dry.

Because of the fuel remaining in the tank, the top-up quantity may be less than the specified tank capacity.

Engine coolant temperature gauge



Displays the coolant temperature.

left area : engine operating temperature not yet reached

central area : normal operating temperature

right area : temperature too high

Caution

If engine coolant temperature is too high, stop vehicle, switch off engine. Danger to engine. Check coolant level.

Service display

The engine oil life system lets you know when to change the engine oil and filter. Based on driving conditions, the interval at which an engine oil and filter change will be indicated can vary considerably.

To display the remaining engine oil life duration use turn signal lever buttons:

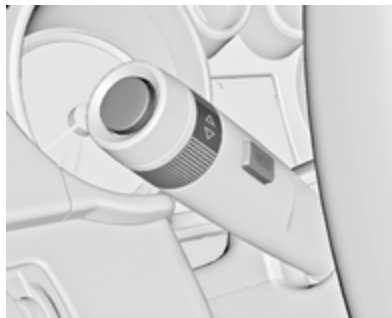

Press **MENU** to select the **Vehicle Information Menu** .

Turn the adjuster wheel to select **Remaining Oil Life**.

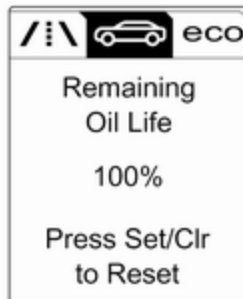

The remaining engine oil life duration is displayed in percent in the Driver Information Centre.

Reset

Press **SET/CLR** on turn signal lever for several seconds to reset. The remaining engine oil life duration page must be active. Switch on ignition, but not the engine.

The system must be reset every time the engine oil is changed, to ensure proper functionality. Seek the assistance of a workshop.

Next service

When the system has calculated that engine oil life has diminished, a warning message appears in the Driver Information Centre. Have engine oil and filter changed by a workshop within one week or 500 km (whichever occurs first).

Driver Information Centre  96.

Service information  235.

Control indicators

The control indicators described are not present in all vehicles. The description applies to all instrument versions. Depending on the equipment, the position of the control indicators may vary. When the ignition is switched on, most control indicators will illuminate briefly as a functionality test.

The control indicator colours mean:

- red : danger, important reminder
- yellow : warning, information, fault
- green : confirmation of activation
- blue : confirmation of activation
- white : confirmation of activation

Control indicators in the instrument cluster

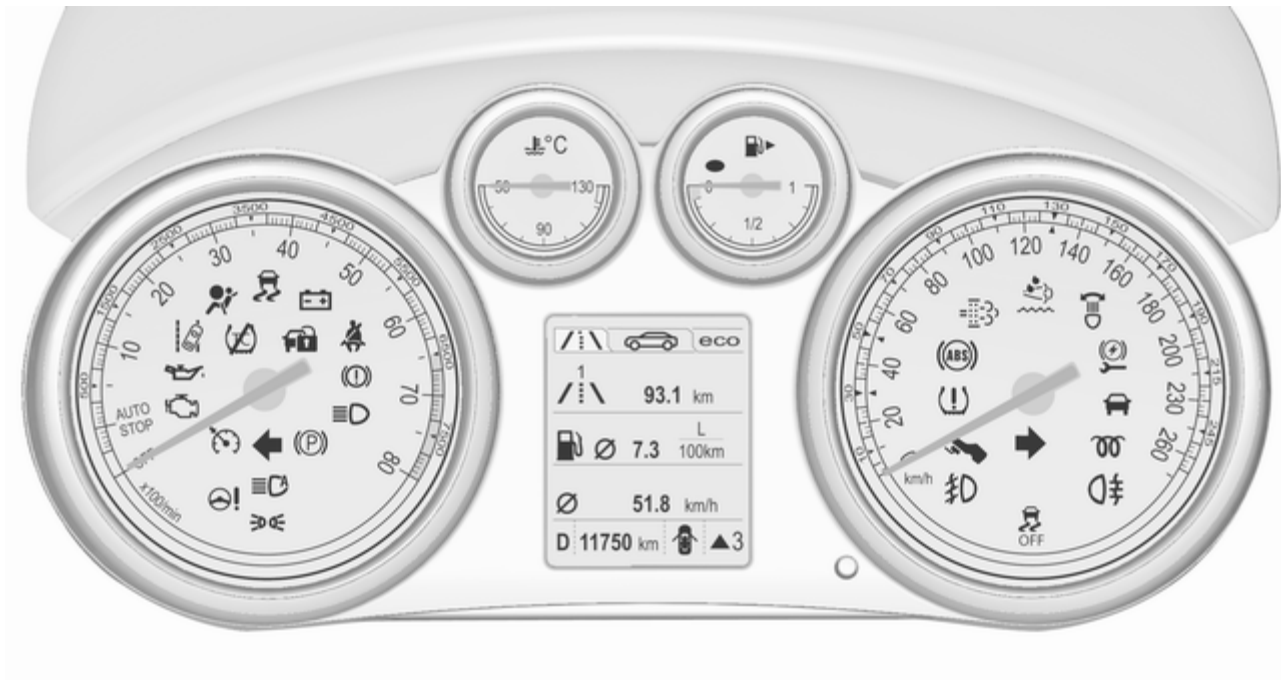

Control indicators in the centre console



Overview

- ↔ Turn signal ⇨ 90
- 🚗 Seat belt reminder ⇨ 91
- 🚒 Airbag and belt tensioners and roll bars ⇨ 91
- 🚒 Airbag deactivation ⇨ 91
- 🔌 Charging system ⇨ 91
- 🚗 Malfunction indicator light ⇨ 92
- 🚗 Brake and clutch system ⇨ 92

- 🚗 Operate pedal ⇨ 92
- 🚗 Electric parking brake ⇨ 92
- 🚗 Electric parking brake fault ⇨ 93
- 🚗 Antilock brake system (ABS) ⇨ 93
- ▲ Upshift ⇨ 93
- 🚗 Power steering ⇨ 93
- 🚗 Lane departure warning ⇨ 93
- 🚗 Electronic Stability Control off ⇨ 94
- 🚗 Electronic Stability Control and Traction Control system ⇨ 94
- 🚗 Traction Control system off ⇨ 94
- 🚗 Preheating ⇨ 94
- 🚗 Exhaust filter ⇨ 94
- 🚗 AdBlue ⇨ 94
- 🚗 Tyre pressure monitoring system ⇨ 94
- 🚗 Engine oil pressure ⇨ 95

- Low fuel ⇨ 95
- 🚗 Immobiliser ⇨ 95
- 🚗 Exterior light ⇨ 95
- 🚗 High beam ⇨ 95
- 🚗 High beam assist ⇨ 96
- 🚗 Adaptive forward lighting ⇨ 96
- 🚗 Fog light ⇨ 96
- 🚗 Rear fog light ⇨ 96
- 🚗 Cruise control ⇨ 96
- 🚗 Vehicle detected ahead ⇨ 96
- 🚗 Door open ⇨ 96

Turn lights

↔ illuminates or flashes green.

Illuminates briefly

The parking lights are switched on.

Flashes

A turn signal or the hazard warning flashers are activated.

Rapid flashing: failure of a turn signal light or associated fuse, failure of turn signal light on trailer.

Bulb replacement ⇨ 198, Fuses ⇨ 206.

Turn signals ⇨ 122.

Seat belt reminder

Seat belt reminder on front seats

 for driver's seat illuminates or flashes red.

 for front passenger seat illuminates or flashes red, when seat is occupied.

Illuminates

After the ignition has been switched on until the seat belt has been fastened.

Flashes

After having started the engine for a maximum of 100 seconds until the seat belt has been fastened.

Airbag, belt tensioners and roll bars

 illuminates red.

When the ignition is switched on, the control indicator illuminates for approx. 4 seconds. If it does not illuminate, does not extinguish after 4 seconds or illuminates whilst driving, there is a fault in the airbag system, in the belt tensioner or the deployable roll bars. The airbags, belt pretensioners and roll bars may fail to trigger in the event of an accident.

Deployment of the belt tensioners, airbags or deployable roll bars is indicated by continuous illumination of .

Warning

Have the cause of the fault remedied immediately by a workshop.

Airbag system, belt tensioners ⇨ 59, ⇨ 56.

Rollover protection system ⇨ 45.

Airbag deactivation

 illuminates yellow.

The front passenger airbag is activated.

 illuminates yellow.

The front passenger airbag is deactivated ⇨ 63.

Danger

Risk of fatal injury for a child using a child restraint system together with activated front passenger airbag.

Risk of fatal injury for an adult person with deactivated front passenger airbag.

Charging system

 illuminates red.

Illuminates when the ignition is switched on and extinguishes shortly after the engine starts.

Illuminates when the engine is running

Stop, switch off engine. Vehicle battery is not charging. Engine cooling may be interrupted. The brake servo unit may cease to be effective. Seek the assistance of a workshop.

Malfunction indicator light

 illuminates or flashes yellow.

Illuminates when the ignition is switched on and extinguishes shortly after the engine starts.

Illuminates when the engine is running

Fault in the emission control system. The permitted emission limits may be exceeded. Seek the assistance of a workshop immediately.

Flashes when the engine is running

Fault that could lead to catalytic converter damage. Ease up on the accelerator until the flashing stops. Seek the assistance of a workshop immediately.

Brake and clutch system

 illuminates red.

The brake and clutch fluid level is too low ⇨ 196.

 Warning

Stop. Do not continue your journey. Consult a workshop.

Illuminates after the ignition is switched on if the manual parking brake is applied ⇨ 153.

Operate pedal

 illuminates or flashes yellow.

Illuminates

Brake pedal must be depressed to release the electric parking brake ⇨ 153.

Clutch pedal must be depressed to start the engine in Autostop mode. Stop-start system ⇨ 140.

Flashes

Clutch pedal must be depressed to start the engine with the key ⇨ 18, ⇨ 139.

On some versions, the message to operate the clutch pedal is indicated in the Driver Information Centre ⇨ 103.

Electric parking brake

 illuminates or flashes red.

Illuminates

Electric parking brake is applied ⇨ 153.

Flashes

Electric parking brake is not fully applied or released. Switch on ignition, depress brake pedal and attempt to reset the system by first releasing and then applying the electric parking brake. If  remains flashing, do not drive and seek the assistance of a workshop.

Electric parking brake fault

 illuminates or flashes yellow.

Illuminates

Electric parking brake is operating with degraded performance  153.

Flashes

Electric parking brake is in service mode. Stop vehicle, apply and release the electric parking brake to reset.

Warning

Have the cause of the fault remedied immediately by a workshop.

Antilock brake system (ABS)

 illuminates yellow.

Illuminates for a few seconds after the ignition is switched on. The system is ready for operation when the control indicator extinguishes.

If the control indicator does not extinguish after a few seconds, or if it illuminates while driving, there is a fault in the ABS. The brake system remains operational but without ABS regulation.

Antilock brake system  152.

Upshift

 with the number of a higher gear is indicated or pops up as a full page in the Driver Information Centre when upshifting is recommended for fuel saving reasons.

Driver Information Centre  96.

Power steering

 illuminates yellow.

Illuminates with power steering reduced

Power steering is reduced due to overheating of the system. Control indicator extinguishes when the system has cooled down.

Stop-start system  140.

Illuminates with power steering disabled

Failure in the power steering system. Consult a workshop.

Lane departure warning

 illuminates green or flashes yellow.

Illuminates green

System is switched on and ready to operate.

Flashes yellow

System recognises an unintended lane change.

Electronic Stability Control off

 illuminates yellow.

The system is deactivated.

Electronic Stability Control and Traction Control system

 illuminates or flashes yellow.

Flashes

The system is actively engaged. Engine output may be reduced and the vehicle may be braked automatically to a small degree.

Illuminates

A fault in the system is present. A warning message appears in the Driver Information Centre. Continued driving is possible. The system is not

operational. Driving stability, however, may deteriorate depending on road surface conditions.

Have the cause of the fault remedied by a workshop.

Electronic Stability Control (ESC)
 156, Traction Control system (TC)
 155.

Traction Control system off

 illuminates yellow.

The system is deactivated.

Preheating

 illuminates yellow.

Preheating is activated. Only activates when outside temperature is low.

Exhaust filter

 illuminates or flashes yellow.

The exhaust filter requires cleaning.



Continue driving until  extinguishes. If possible, do not allow engine speed to drop below 2000 rpm.

Illuminates

The exhaust filter is full. Start cleaning process as soon as possible.

Flashes

The maximum filling level of the filter is reached. Start cleaning process immediately to avoid damage to the engine.

Exhaust filter  144, Stop-start system  140.

AdBlue

 flashes yellow.

AdBlue level is low. Refill AdBlue soon to avoid prevention of the engine start.

AdBlue  145.

Tyre pressure monitoring system

 illuminates or flashes yellow.

Illuminates

Tyre pressure loss. Stop immediately and check tyre pressure.

Flashes

Fault in system or tyre without pressure sensor mounted (e.g. spare wheel). After 60-90 seconds the control indicator illuminates continuously. Consult a workshop.

Tyre pressure monitoring system ↻ 213.

Engine oil pressure

 illuminates red.

Illuminates when the ignition is switched on and extinguishes shortly after the engine starts.

Illuminates when the engine is running

Caution

Engine lubrication may be interrupted. This may result in damage to the engine and/or locking of the drive wheels.

1. Depress clutch.
2. Select neutral gear, set selector lever to **N**.

3. Move out of the flow of traffic as quickly as possible without impeding other vehicles.
4. Switch off ignition.

Warning

When the engine is off, considerably more force is needed to brake and steer. During an Autostop the brake servo unit will still be operational.

Do not remove key until vehicle is stationary, otherwise the steering wheel lock could engage unexpectedly.

Check oil level before seeking the assistance of a workshop ↻ 193.

Low fuel

 illuminates or flashes yellow.

Illuminates

Level in fuel tank is too low.

Flashes

Fuel used up. Refuel immediately. Never run the tank dry.

Catalytic converter ↻ 145.

Bleeding the diesel fuel system ↻ 197.

Immobiliser

 flashes yellow.

Fault in the immobiliser system. The engine cannot be started.

Exterior light

 illuminates green.

The exterior lights are on ↻ 114.

High beam

 illuminates blue.

Illuminates when high beam is on or during headlight flash ↻ 116, or when high beam is on with high beam assist or intelligent light range ↻ 118.

High beam assist

 illuminates green.

The high beam assist or intelligent light range is activated ⇨ 116, ⇨ 118.

Adaptive forward lighting

 illuminates or flashes yellow.

Illuminates

Fault in system.

Seek the assistance of a workshop.

Flashes

System switched to symmetrical low beam.

Control indicator  flashes for approx. 4 seconds after the ignition is switched on as a reminder that the system has been activated ⇨ 117.

Automatic light control ⇨ 115.

Fog light

 illuminates green.

The front fog lights are on ⇨ 122.

Rear fog light

 illuminates yellow.

The rear fog light is on ⇨ 122.

Cruise control

 illuminates white or green.

Illuminates white

The system is on.

Illuminates green

Cruise control is active.

Cruise control ⇨ 159.

Vehicle detected ahead

 illuminates green.

A vehicle ahead is detected in the same lane.

Forward collision alert ⇨ 162.

Door open

 is indicated as symbol in the Driver Information Centre when a door or the boot lid is open.



Displays

Driver Information Centre

The Driver Information Centre is located in the instrument cluster between speedometer and tachometer.

The following main menus can be indicated in the display and selected by pushing **MENU** on the turn signal lever. Menu symbols are indicated in the top line of the display:



- **Vehicle Information Menu** 
- **Trip/Fuel Information Menu** 
- **ECO Information Menu** **ECO**

Some of the displayed functions differ when the vehicle is being driven or at a standstill. Some functions are only available when the vehicle is being driven.

Vehicle personalisation ⇨ 104.

Memorised settings ⇨ 23.

Selecting menus and functions

The menus and functions can be selected via the buttons on the turn signal lever.



Press **MENU** to switch between the menus or to return from a submenu to the next higher menu level.



Turn the adjuster wheel to highlight a menu option or set a numeric value.



Press **SET/CLR** to select a function or confirm a message.

Vehicle Information Menu

Press **MENU** to select .

Turn the adjuster wheel to select a submenu. Press **SET/CLR** to confirm.

Follow the instructions given in the submenus.

Depending on the version, the possible submenus may include:

- **Unit:** displayed units can be changed
- **Tyre Pressure:** checks tyre pressure of all wheels during driving ⇨ 213
- **Tyre Load:** select tyre pressure category according to the actually inflated tyre pressure ⇨ 213

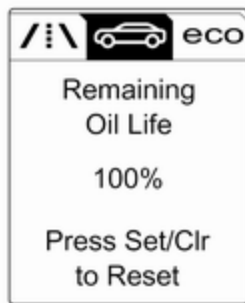

- **Remaining Oil Life:** indicates when to change the engine oil and filter ↷ 87

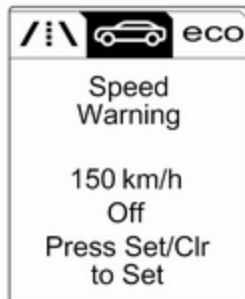

- **Speed Warning:** if exceeding the preset speed, a warning chime will be activated
- **Traffic Sign Assistant:** displays detected traffic signs for the current route section ↷ 176
- **Following Dist.:** displays the distance to a preceding moving vehicle ↷ 164

Trip/Fuel Information Menu /: \

Press **MENU** to select /: \.

Turn the adjuster wheel to select a page:



Page 1:

- trip odometer 1
- average consumption 1
- average speed 1



Page 2:

- trip odometer 2
- average consumption 2
- average speed 2



Page 3:

- digital speed
- range
- instantaneous consumption

The information of page 1 and page 2 can be reset separately for odometer, average consumption and average speed, making it possible to display different trip information. Select pages by turning the adjuster wheel on the turn signal lever.



Trip odometer 1 or 2

Trip odometer displays the recorded distance since a certain reset.

Trip odometer counts up to a distance of 9,999 km and then restarts at 0.

Reset trip odometer by pressing **SET/CLR** on the turn signal lever for a few seconds or by pressing the reset knob near the speedometer separately for selected page 1 or 2.

Average consumption 1 or 2

Display of average consumption. The measurement can be reset at any time and starts with a default value.

To reset, press **SET/CLR** for a few seconds separately for selected page 1 or 2.

Average speed 1 or 2

Display of average speed. The measurement can be reset at any time.

To reset, press **SET/CLR** for a few seconds separately for selected page 1 or 2.

Digital speed

Digital display of the instantaneous speed.

Range

Range is calculated from current fuel tank content and current consumption. The display shows average values.

After refuelling, the range is updated automatically after a brief delay.

When the fuel level in the tank is low, a message appears in the display.

When the tank must be refuelled immediately, a warning message is displayed.

Additionally, the control indicator ● in the fuel gauge illuminates or flashes ⇨ 95.

Instantaneous consumption

Displays the instantaneous consumption.

ECO Information Menu ECO

Press **MENU** to select **ECO**.

Turn the adjuster wheel to select a page:

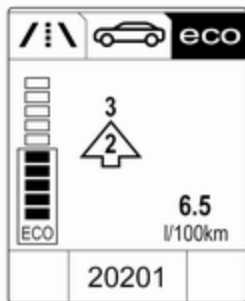

- **Shift indication:** Current gear is indicated inside an arrow. The digit above recommends

upshifting for fuel saving reasons.

Eco index display: The current fuel consumption is indicated on a segment display. For economical driving adapt your driving style to keep the filled segments within the Eco area. The more segments are filled, the higher the fuel consumption. Simultaneously the current consumption value is indicated.



- **Top Consumers:** List of top comfort consumers currently switched on is displayed in descending order. Fuel saving potential is indicated. A switched-

off consumer disappears from the list and the consumption value will be updated.

During sporadic driving conditions, the heated rear window is activated automatically to increase engine load. In this event, the heated rear window is indicated as one of the top consumers, without activation by the driver.

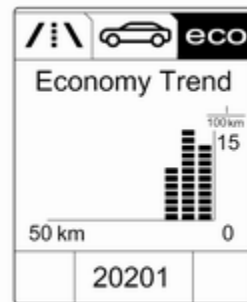

- **Economy Trend:** Displays the average consumption development over a distance of 50 km. Filled segments display the consumption in 5 km steps

and shows the effect of topography or driving behaviour on fuel consumption.

Info Display

Depending on the vehicle configuration the vehicle has a Graphic-Info-Display or a Colour-Info-Display.

The Info-Display is located in the instrument panel above the Infotainment system.

Graphic-Info-Display

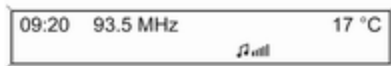

Depending on the Infotainment system, the Graphic-Info-Display is available in two versions.



20153

Graphic-Info-Display indicates:

- time ↻ 82
- outside temperature ↻ 81
- date ↻ 82
- electronic climate control settings ↻ 130
- Infotainment system, see description in the Infotainment manual
- settings for vehicle personalisation ↻ 104

Colour-Info-Display



The Colour-Info-Display indicates in colour:

- time ↻ 82
- outside temperature ↻ 81
- date ↻ 82
- electronic climate control settings ↻ 130
- rear view camera ↻ 174
- Infotainment system, see description in the Infotainment manual
- navigation, see description in the Infotainment manual

- system settings
- vehicle messages ⇨ 103
- settings for vehicle personalisation ⇨ 104

The type of information and how it is displayed depends on the equipment of the vehicle and the settings made.

Selecting menus and settings

Menus and settings are accessed via the display.



Press **CONFIG**: Menu page **Settings** is displayed.

Turn multifunction knob to:

- Select a setting or value.
- Display a menu option.

Press multifunction knob to:

- Confirm a setting or value.
- Select or activate the marked option.
- Switch a system function on/off.

Press **BACK** to:

- Exit a menu or setting without changing.
- Return from a submenu to a higher menu level.
- Delete the last character in a character sequence. Press and hold **BACK** for a few seconds to delete the entire entry.



To exit the **Settings** menu, press **BACK** repeatedly or press **CONFIG** after confirming the changes.

Vehicle personalisation ⇨ 104.

Memorised settings ⇨ 23.

Vehicle messages

Messages are indicated in the Driver Information Centre, in some cases together with a warning and signal sound.

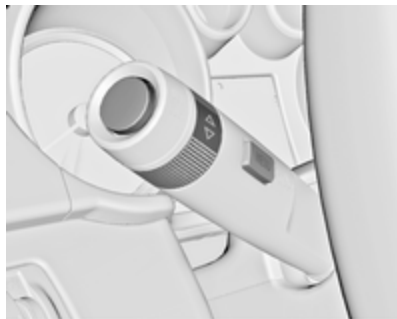

Press **SET/CLR**, **MENU** or turn the adjuster wheel to confirm a message.

Messages in the Driver Information Centre



The vehicle messages are displayed as text. Follow the instructions given in the messages.

Messages in the Colour-Info-Display

Some important messages may appear additionally in the Colour-Info-Display. Press the multifunction knob to confirm a message. Some messages only pop-up for a few seconds.

Warning chimes

When starting the engine or whilst driving

Only one warning chime will sound at a time.

The warning chime regarding unfastened seat belts has priority over any other warning chime.

- If seat belt is not fastened.
- If a door or the boot lid is not fully closed when starting off.
- If the soft top is not completely opened or closed.
- If the soft top lid is not completely closed.
- If the load compartment partition is folded in when operating the soft top.
- If a certain speed is exceeded with parking brake applied.
- If a certain speed is exceeded when operating the soft top.
- If a programmed speed or speed limit is exceeded.

- If a warning message appears in the Driver Information Centre.
- If the parking assist detects an object.
- If unintended lane change occurs.
- If the exhaust filter has reached the maximum filling level.

When the vehicle is parked and/or the driver's door is opened

- With exterior lights on.

During an Autostop

- If the driver's door is opened.

Battery voltage

When the vehicle battery voltage is running low, a warning message will appear in the Driver Information Centre.

1. Switch off immediately any electrical consumers which are not required for a safe ride, e.g. seat heating, heated rear window or other main consumers.
2. Charge the vehicle battery by driving continuously for a while or by using a charging device.

The warning message will disappear after the engine has been started twice consecutively without a voltage drop.

If the vehicle battery cannot be recharged, have the cause of the fault remedied by a workshop.

Vehicle personalisation

The vehicle's behaviour can be personalised by changing the settings in the Info-Display.

Some of the personal settings for different drivers can be memorised individually for each vehicle key. Memorised settings ⇨ 23.

Depending on vehicle equipment and country-specific regulations, some of the functions described below may not be available.

Some functions are only displayed or active when the engine is running.

Personal settings in the Graphic-Info-Display

CD 400plus/CD 400/CD 300

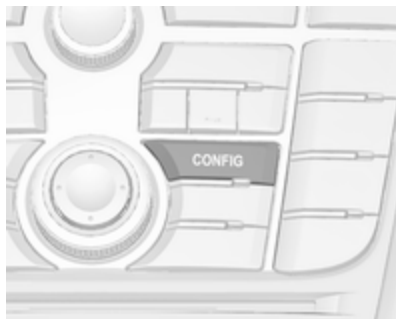

Press **CONFIG**. The menu **Settings** is displayed.

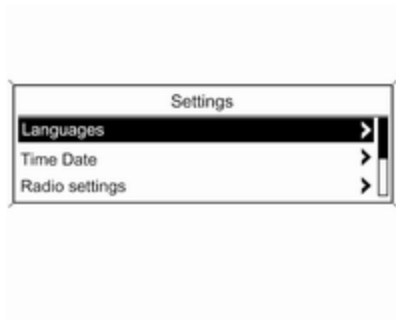

The following settings can be selected by turning and pressing the multifunction knob:

- **Sport mode settings**
- **Languages**
- **Time Date**
- **Radio settings**
- **Phone settings**
- **Vehicle settings**

In the corresponding submenus the following settings can be changed:

Sport mode settings

The driver can select the functions which will be activated in Sport mode ⇨ 157.

- **Sport suspension:** Damping becomes harder.
- **Sport powertrain performance:** Accelerator pedal and gear change characteristics become more responsive.
- **Sport steering:** Steering support is reduced.
- **Swap backlight colour main instr.:** Changes the instrument illumination colour.

Languages

Selection of the desired language.

Time Date

See 'Clock' ⇨ 82.

Radio settings

See Infotainment manual for further information.

Phone settings

See Infotainment manual for further information.

Vehicle settings

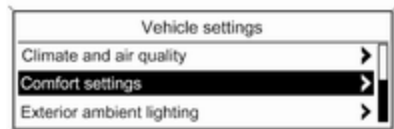

- **Climate and air quality**

Auto fan speed: Modifies the level of the cabin airflow of the climate control in automatic mode.

Climate control mode: Controls the state of the cooling compressor when the vehicle is started. Last setting (recommended) or at vehicle start is either always ON or always OFF.

Auto rear demist: Activates heated rear window automatically.

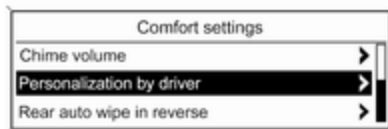

20340

- **Comfort settings**

Chime volume: Changes the volume of warning chimes.

Personalization by driver: Activates or deactivates the personalisation function.

- **Park assist / Collision detection**

Park assist: Activates or deactivates the ultrasonic sensors. Activation is selectable with or without attached trailer coupling.

Side blind zone alert: Changes the settings for the side blind spot alert system.

- **Exterior ambient lighting**

Duration upon exit of vehicle: Activates or deactivates and changes the duration of exit lighting.

Exterior lighting by unlocking: Activates or deactivates the welcome lighting.

- **Power door locks**

Auto door lock: Activates or deactivates the automatic door unlocking function after switching off ignition. Activates or deactivates the automatic door locking function after driving-off.

Stop door lock if door open: Activates or deactivates the automatic door locking function while a door is open.

Delayed door lock: Activates or deactivates the delayed door locking function.

- **Remote locking, unlocking, starting**

Remote unlock feedback: Activates or deactivates the hazard warning flasher feedback whilst unlocking.

Remote door unlock: Changes the configuration to unlock only the driver's door or the whole vehicle whilst unlocking.

Auto relock doors: Activates or deactivates the automatic relock function after unlocking without opening the vehicle.

- **Restore factory settings**

Restore factory settings: Resets all settings to the default settings.

Settings in the Colour-Info-Display

Navi 950/Navi 650/CD 600

Press **CONFIG** on the Infotainment system faceplate to enter the Configuration menu.

Turn the multifunction knob to scroll upwards or downwards in the list.

Press the multifunction knob (Navi 950 / Navi 650: press the outer ring) to select a menu item.



- **Sport Mode Profile**
- **Languages**
- **Time and Date**
- **Radio Settings**
- **Phone Settings**
- **Navigation Settings**
- **Display Settings**
- **Vehicle Settings**

In the corresponding submenus the following settings can be changed:

Sport Mode Profile

- **Engine Sport Performance:** Accelerator pedal and gear change characteristics become more responsive.
- **Sport Mode Back Lighting:** Changes the instrument illumination colour.
- **Sport Suspension:** Damping becomes harder.
- **Sport Steering:** Steering support is reduced.

Languages

Selection of the desired language.

Time and Date

See Infotainment manual for further information.

Radio Settings

See Infotainment manual for further information.

Phone Settings

See Infotainment manual for further information.

Navigation Settings

See Infotainment manual for further information.

Display Settings

- **Home Page Menu:**

See Infotainment manual for further information.

- **Rear Camera Options:**

Press to adjust the rear camera options ↻ 174.

- **Display Off:**

See Infotainment manual for further information.

- **Map Settings:**

See Infotainment manual for further information.

Vehicle Settings

- **Climate and Air Quality**

Auto Fan Speed: Modifies the level of the cabin airflow of the climate control in automatic mode.

Air Conditioning Mode: Controls the state of the cooling compressor when the vehicle is started. Last setting

(recommended) or at vehicle start is either always ON or always OFF.

Auto Rear Demist: Activates heated rear window automatically.

- **Comfort and Convenience**

Chime Volume: Changes the volume of warning chimes.

Personalisation by Driver: Activates or deactivates the personalisation function.

- **Collision Detection Systems**

Park Assist: Activates or deactivates the ultrasonic sensors. Activation is selectable with or without attached trailer coupling.

Side Blind Zone Alert: Activates or deactivates the side blind spot alert system.

- **Lighting**

Vehicle Locator Lights: Activates or deactivates the entry lighting.

Exit Lighting: Activates or deactivates and changes the duration of exit lighting.

- **Power Door Locks**

Open Door Anti Lock Out: Activates or deactivates the automatic door locking function while a door is open.

Auto Door Lock: Activates or deactivates the automatic door unlocking function after switching off ignition. Activates or deactivates the automatic door locking function after driving-off.

Delay Door Lock: Activates or deactivates the delayed door locking function.

- **Remote Lock/Unlock/Start**

Remote Lock Feedback: Activates or deactivates the hazard warning flasher feedback whilst locking.

Remote Unlock Feedback: Activates or deactivates the hazard warning flasher feedback whilst unlocking.

Remote Door Unlock: Changes the configuration to unlock only the driver's door or the whole vehicle whilst unlocking.

Relock Remotely Unlocked

Doors: Activates or deactivates the automatic relock function after unlocking without opening the vehicle.

- **Return to Factory Settings?:** Resets all settings to the default settings.

Telematics service

OnStar

OnStar is a personal connectivity and service assistant with integrated Wi-Fi hotspot. The OnStar service is available 24 hours a day, seven days a week.

Note

OnStar is not available for all markets. For further information, contact your workshop.

Note

In order to be available and operational, OnStar needs a valid OnStar subscription, functioning vehicle electrics, mobile service and GPS satellite link.

To activate the OnStar services and set up an account, press  and speak with an advisor.

Depending on the equipment of the vehicle, the following services are available:

- Emergency services and support in the case of a vehicle breakdown
- Wi-Fi hotspot
- Smartphone application
- Remote control, e.g. location of the vehicle, activation of horn and lights, control of central locking system
- Stolen vehicle assistance
- Vehicle diagnostics
- Destination download

Note

The OnStar module of the vehicle is deactivated after ten days without an ignition cycle. Functions requiring a data connection will be available again after switching on the ignition.

OnStar buttons



Privacy button

Press and hold  until a message is heard to activate or deactivate the transmission of the vehicle location.

Press  to answer a call or to end a call to an advisor.

Press  to access the Wi-Fi settings.

Service button

Press  to establish a connection to an advisor.

SOS button

Press  to establish a priority emergency connection to a specially trained emergency advisor.

Status LED

Green: The system is ready with activated transmission of the vehicle location.

Green flashing: The system is on a call.

Red: A problem arose.

Off: The system is ready with deactivated transmission of the vehicle location or the system is in standby mode.

Red / green flashing for a short period of time: The transmission of the vehicle location has been deactivated.

OnStar services

General services

If you need any information e.g. opening hours, points of interest and destinations or if you need any support e.g. in the case of a vehicle

breakdown, a flat tyre and empty fuel tank, press  to establish a connection to an advisor.

Emergency services

In the case of an emergency situation, press  and talk to an advisor. The advisor then contacts emergency or assistance service providers and directs them to your vehicle.

In the case of an accident with activation of airbags or belt tensioners, an automatic emergency call is established. The advisor is immediately connected to your vehicle to see whether help is needed.

Wi-Fi hotspot

The Wi-Fi hotspot of the vehicle provides internet connectivity with a maximum speed of 4G/LTE.

Note

The Wi-Fi hotspot functionality is not available for all markets.

Up to seven devices may be connected.

To connect a mobile device with the Wi-Fi hotspot:

1. Press  and then select Wi-Fi settings on the Info-Display. The settings displayed include the Wi-Fi hotspot name (SSID), password and connection type.
2. Start a Wi-Fi network search on your mobile device.
3. Select your vehicle hotspot (SSID) when listed.
4. When prompted, enter the password on your mobile device.

Note

To change the SSID or password, press  and talk to an advisor or log in to your account.

To switch off the Wi-Fi hotspot functionality, press  to call an advisor.

Smartphone app

With the myOpel smartphone app, some vehicle functions can be operated remotely.

The following functions are available:

- Lock or unlock vehicle.
- Honk horn or flash lights.
- Check fuel level, engine oil life and tyre pressure (only with tyre pressure monitoring system).
- Send navigation destination to the vehicle, if equipped with a built-in navigation system.
- Locate vehicle on a map.
- Manage Wi-Fi settings.

To operate these functions, download the app from App Store® or Google Play™ Store.

Remote control

If desired, use any phone to call an advisor, who can remotely operate specific vehicle functions. Find the respective OnStar phone number on our country-specific website.

The following functions are available:

- Lock or unlock vehicle.
- Provide information on the vehicle location.
- Honk horn or flash lights.

Stolen vehicle assistance

If the vehicle is stolen, report the theft to the authorities and request OnStar stolen vehicle assistance. Use any phone to call an advisor. Find the respective OnStar phone number on our country-specific website.

OnStar can provide support in locating and recovering the vehicle.

Theft alert

When the anti-theft alarm system is triggered, a notification is sent to OnStar. You are then informed about this event by text message or email.

Restart prevention

By sending remote signals, OnStar can prevent the vehicle from restarting once it has been turned off.

On-demand diagnostics

At any time e.g. if the vehicle displays a vehicle message, press  to contact an advisor and ask to complete a real-time diagnostic check to directly determine the issue. Depending on the results, the advisor will provide further support.

Diagnostic report

The vehicle automatically transmits diagnostic data to OnStar which sends a monthly email report to you and your preferred workshop.

Note

The workshop notification function can be disabled in your account.

The report contains the status of key operating systems of the vehicle like engine, transmission, airbags, ABS, and other major systems. It also provides information on possible maintenance items and tyre pressure (only with tyre pressure monitoring system).

To look at the information in greater detail, select the link within the email and log in to your account.

Destination download

A desired destination can be directly downloaded to the navigation system.

Press  to call an advisor and describe the destination or point of interest.

The advisor can look up any address or point of interest and directly send the destination to the built-in navigation system.

OnStar settings

OnStar PIN

To have full access to all OnStar services, a four-digit PIN is required. The PIN has to be personalised when first talking to an advisor.

To change the PIN, press  to call an advisor.

Account data

An OnStar subscriber has an account where all the data is stored. To request a change of the account information, press  and talk to an advisor or log in to your account.

If the OnStar service is used on another vehicle, press  and request that the account be transferred to the new vehicle.

Note

In any case, if the vehicle is disposed of, sold or otherwise transferred, immediately inform OnStar about the changes and terminate the OnStar service on this vehicle.

Vehicle location

The vehicle location is transmitted to OnStar when service is requested or triggered. A message on the Info-Display informs about this transmission.

To activate or deactivate the transmission of the vehicle location, press and hold  until an audio message is heard.

The deactivation is indicated by the status light flashing red and green for a short period of time and each time the vehicle is started.

Note

If the transmission of the vehicle location is deactivated, some services are no longer available.

Note

The vehicle location always remains accessible to OnStar in the case of an emergency.

Find the privacy policy in your account.

Software updates

OnStar may remotely carry out software updates without further notice or consent. These updates are to enhance or maintain safety and security or the operation of the vehicle.

These updates may concern privacy issues. Find the privacy policy in your account.

Lighting

Exterior lighting	114
Light switch	114
Automatic light control	115
High beam	116
High beam assist	116
Headlight flash	117
Headlight range adjustment	117
Headlights when driving abroad	117
Daytime running lights	118
Adaptive forward lighting	118
Hazard warning flashers	121
Turn lights	122
Front fog lights	122
Rear fog lights	122
Parking lights	123
Reversing lights	123
Misted light covers	123
Interior lighting	123
Instrument panel illumination control	123
Interior lights	124
Reading lights	124
Sunvisor lights	124

Lighting features	125
Entry lighting	125
Exit lighting	125
Battery discharge protection	126

Exterior lighting

Light switch



Turn light switch:

- O** : lights off
- ☞☞** : sidelights
- ≡D** : headlights

Control indicator ☞☞ ↻ 95.

Light switch with Automatic light control



Turn light switch:

- AUTO** : automatic light control: Headlights are switched on and off automatically depending on external lighting conditions.
- ⏻ : activation or deactivation of the automatic light control. Switch turns back to **AUTO**.
- ☞☞ : sidelights
- ☞D : headlights

A status message in the Driver Information Centre indicates the current status of the automatic light control.

When switching on the ignition, automatic light control is active.

When headlights are on, ☞☞ illuminates. Control indicator ☞☞ ☞ 95.

Tail lights

Tail lights are illuminated together with headlights and sidelights.

Additional lights in the boot lid frame

Additional tail light assemblies, existing of tail lights and hazard warning flasher lights, are located in the boot lid frame. They are illuminated when lights are activated and the boot lid is open. Additional tail lights are only intended as position lights when the boot lid is open. They are not to be used while driving.

Automatic light control



When the automatic light control function is switched on and the engine is running, the system switches between daytime running lights and headlights automatically depending on the external lighting conditions and information given by the rain sensor system.

When the automatic light control function is switched on and the engine is running, the system switches between daytime running lights and headlights automatically depending on the external lighting conditions.

Daytime running light ⇨ 118.

Automatic headlight activation

During poor lighting conditions the headlights are switched on.

Furthermore, the headlights are switched on if the windscreen wipers have been activated for several wipes.

Tunnel detection

When a tunnel is entered headlights are switched on immediately.

Adaptive forward lighting ⇨ 118.

High beam

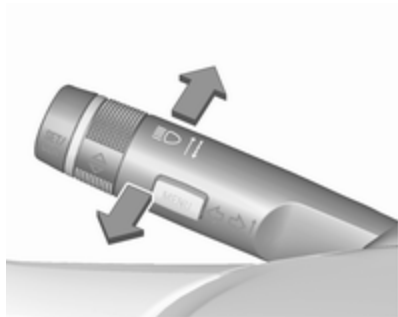

To switch from low to high beam, push lever.

To switch to low beam, push lever again or pull.

High beam assist

Description for version with halogen headlights. High beam assist with adaptive forward lighting ⇨ 118.

This feature allows high beam to function as the main driving light at night and when vehicle speed is faster than 40 km/h.

It switches to low beam when:



- A sensor detects the lights of oncoming or preceding vehicles.
- The vehicle speed is slower than 20 km/h.
- It is foggy or snowy.
- Driving in urban areas.

If there are no restrictions detected, the system switches back to high beam.

Activation



The high beam assist is activated by pushing the indicator lever twice at a speed above 40 km/h.

The green control indicator  illuminates continuously when the assist is activated, the blue one  illuminates when high beam is on.

Control indicator  ⇨ 95.

Deactivation

Push indicator lever once. It is also deactivated when front fog lights are switched on.

If a headlight flash is activated when the high beam is on, the high beam assist will be deactivated.

If a headlight flash is activated when the high beam is off, the high beam assist will remain activated.

The latest setting of the high beam assist will remain after the ignition is switched on again.

Headlight flash

To activate the headlight flash, pull lever.

Headlight range adjustment

Manual headlight range adjustment



To adapt headlight range to the vehicle load to prevent dazzling: turn thumb wheel  to required position.

- 0 : front seats occupied
- 1 : all seats occupied
- 2 : all seats occupied and load compartment laden
- 3 : driver's seat occupied and load compartment laden.

Dynamic automatic headlight levelling ⇨ 118.

Headlights when driving abroad

The asymmetrical headlight beam extends visibility at the edge of the road at the passenger side.

However, when driving in countries where traffic drives on the opposite side of the road, adjust the headlights to prevent dazzling of oncoming traffic.

Vehicles with halogen headlight system

The headlights do not have to be adjusted.

Vehicles with Xenon headlight system

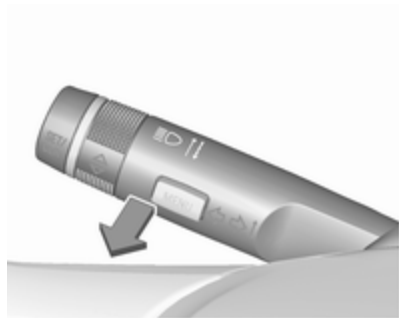

1. Key in ignition switch.
2. Pull turn signal lever and hold (headlight flash).
3. Switch on ignition.
4. After approx. 5 seconds the control indicator ⌘ starts flashing and an acoustic signal sounds.

Control indicator ⌘ \rightarrow 96.

Every time the ignition is switched on, ⌘ flashes as a reminder for approx. 4 seconds.

To deactivate, operate the same procedure as described above. Control indicator ⌘ will not flash when function is deactivated.

Daytime running lights

Daytime running lights increase visibility of the vehicle during daylight.

They are switched on automatically when ignition is on.

If the vehicle is equipped with automatic light control function, the system switches between daytime running light and low/high beam automatically, depending on the lighting conditions and information given by the rain sensor system. Automatic light control ⌘ 115.

Adaptive forward lighting

The Adaptive forward lighting functions are only available with Bi-Xenon headlights. Light range, light distribution and intensity of light are variably triggered depending on the light conditions, weather and road type.

With the light switch in position **AUTO** all lighting functions are available.

The following functions are available also with light switch in position ⌘ :

- dynamic curve lighting
- cornering light
- reversing function
- dynamic automatic headlight levelling

Playstreet lighting

Activated automatically at low speed up to approx. 30 km/h. The light beam is turned at an angle of 8° to the roadside.

Town lighting

Activated automatically at a speed range between approx. 40 and 55 km/h and when street lights are detected by the light sensor. The light range is reduced by an extended light distribution.

Country lighting

Activated automatically at a speed range between approx. 55 and 115 km/h. The beam of light and the brightness is different between the left and the right side.

Motorway lighting

Activated automatically at a speed above approx. 115 km/h and minimal steering movements. It switches on after a delay or directly when the vehicle is powerfully accelerated. The light beam is longer and brighter.

Adverse weather lighting

Activated automatically up to a speed of approx. 70 km/h, when the rain sensor recognizes condensation or the wiper operates continuously. The range, distribution and light intensity is regulated variably depending on visibility.

Dynamic curve lighting



The light beam pivots based on steering wheel angle and speed, improving lighting in curves. Control indicator  96.

Corner lighting



On tight bends or when turning off, depending on the steering angle or the turn signal light, an additional left or right reflector is switched on which illuminates the road at a right angle to the direction of travel. It is activated up to a speed of 40 km/h. Control indicator  96.

Reversing function

If the headlights are on and reverse gear is engaged, both corner lights are switched on. They remain illuminated for 20 seconds after disengaging reverse gear or until driving faster than 17 km/h in a forward gear.

High beam assist



This feature allows high beam as main driving light by night and when vehicle speed is faster than 40 km/h. It switches to low beam when:

- The camera in the windscreen detects the lights of oncoming or preceding vehicles.
- The vehicle speed is slower than 20 km/h.
- It is foggy or snowy.
- Driving in urban areas.

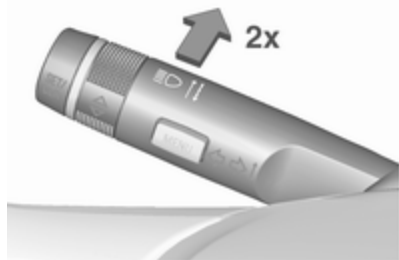
If there are no restrictions detected, the system switches back to high beam.

Activation

The high beam assist is activated by pushing the indicator lever twice with a speed above 40 km/h.

The green control indicator  illuminates continuously when the assist is activated, the blue one  illuminates when high beam is on.

Control indicator   95.

Deactivation

Push indicator lever once. It is also deactivated when front fog lights are switched on.

If a headlight flash is activated when the high beam is on, the high beam assist will be deactivated.

If a headlight flash is activated when the high beam is off, the high beam assist will stay activated.

High beam assist is always active after the ignition is switched on.

Intelligent light ranging with automatic high beam activation

Intelligent light ranging uses the properties of Bi-Xenon headlights to extend the light range of the low beam by up to 400 metres and additionally activates automatic high beam without dazzling or disturbing oncoming or preceding traffic.

High beam is deactivated and the low beam light range is reduced to avoid dazzling when the following restrictions are detected by the front camera in the windscreen:

- A preceding vehicle is recognised.
- An oncoming vehicle is recognised.

- Urban areas are entered.
- It is foggy or snowy.

If there are no restrictions detected, the system switches back to high beam.

When the system is active, the front camera monitors the area ahead of the vehicle and ensures an optimum light distribution for maximum driver vision during almost all conditions.

Intelligent light ranging with automatic high beam activation therefore reduces the difference between conventional low and high beam without drastic changes in light-range, distribution and intensity.

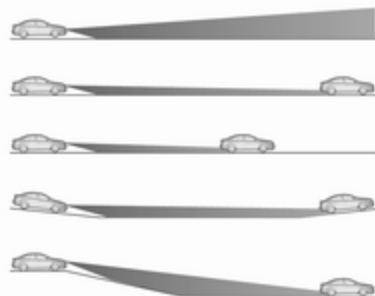



A special topographical evaluation function detects preceding vehicles on hills or slopes by recognising the rear light moving ahead. The system adjusts the height of the light range to ensure optimum illumination on the road ahead without dazzling.

Activation



Intelligent light ranging and automatic high beam activation are switched on together by pushing the indicator lever twice. They can be switched on with ignition on.

Automatic high beam activation operates at a speed above 40 km/h and deactivates below 20 km/h. Intelligent light ranging operates above 55 km/h.

The green control indicator  illuminates continuously when the function is activated, the blue one  illuminates when high beam switches on automatically.

Deactivation

Push indicator lever once. It is also deactivated when front fog lights are switched on.

Dynamic automatic headlight levelling

To prevent oncoming traffic from dazzle, headlight levelling is automatically adjusted based on inclination information measured by front and rear axle, acceleration or deceleration and vehicle speed.

Fault in Adaptive forward lighting system

When the system detects a failure in the Adaptive forward lighting system, the system moves to a preset position to avoid dazzling of oncoming traffic. If this is not possible, the affected headlight will be automatically switched off. In any case, one headlight will stay on. A warning is displayed in the Driver Information Centre.

Hazard warning flashers



Operated by pressing .

In the event of an accident with airbag deployment the hazard warning flashers are activated automatically.

Turn lights

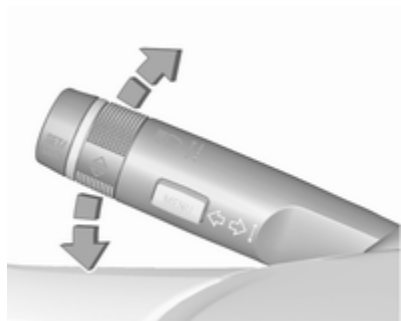

lever up : right turn signal
 lever down : left turn signal

A resistance point can be felt when moving the lever.

Constant flashing is activated when the lever is being moved beyond the resistance point. It is deactivated when the steering wheel is moved in

the opposite direction or lever is manually moved back to its neutral position.

Activate temporary flashing by holding the lever just before the resistance point. Turning lights will flash until lever is being released.

To activate three flashes, tap the lever briefly without passing the resistance point.

When a trailer is connected, turn signal flashes six times when pressing the lever until resistance is felt and then releasing.

Front fog lights



Operated by pressing $\#D$.

Light switch in position **AUTO**: switching on front fog lights will switch headlights on automatically.

Rear fog lights



Operated by pressing $\#D$.

Light switch in position **AUTO**: switching on rear fog light will switch headlights on automatically.

Light switch in position $\Rightarrow E$: rear fog light can only be switched on with front fog lights.

The vehicle rear fog light is deactivated when towing.

Parking lights



When the vehicle is parked, the parking lights on one side can be activated:

1. Switch off ignition.
2. Move turn signal lever all the way up (right parking lights) or down (left parking lights).

Confirmed by a signal and the corresponding turn signal control indicator.

Reversing lights

The reversing light comes on when the ignition is on and reverse gear is selected.

Misted light covers

The inside of the light housing may mist up briefly in poor, wet and cold weather conditions, in heavy rain or after washing. The mist disappears quickly by itself; to help switch on the headlights.

Interior lighting

Instrument panel illumination control



Brightness of the following lights can be adjusted when the exterior lights are on:

- instrument panel illumination
- ambient light
- dome light
- Info-Display
- illuminated switches and operation elements

Turn thumb wheel  and hold until the desired brightness is obtained.

On vehicles with light sensor, the brightness can only be adjusted when the exterior lights are on and the light sensor detects night conditions.

Interior lights

During entry and exit of the vehicle, the front and rear courtesy lights automatically switch on and then off after a delay.

Note

In the event of an accident with airbag deployment the courtesy lights are turned on automatically.

Front courtesy light



Operate rocker switch:

 : automatic switching on and off

press  : on



press  : off



Dome light

Spotlight incorporated in the interior lighting comes on when headlights are switched on.

Ambient light



Ambient light consists of indirect lights in the doors and around the gear selector lever.

Ambient light can be dimmed using thumb wheel  together with the instrument panel illumination  123.

It is also activated with Entry lighting  125 and Exit lighting  125.

Reading lights



Operated by pressing  and  in the courtesy lights.

Sunvisor lights

Illuminates when the cover is opened.

Lighting features

Entry lighting

Welcome lighting

The following lights are switched on for a short time by unlocking the vehicle with the radio remote control:

- headlights
- tail lights
- number plate lights
- instrument panel light
- interior lights
- puddle lights

Some functions work only in the dark and facilitates locating the vehicle.

The lighting switches off immediately when the ignition key is turned to position 1 ⇨ 139.

The following lights will additionally switch on when the driver's door is opened:

- illumination of some switches
- Driver Information Centre

- door pocket lights
- console lights

Activation, deactivation and duration of this function can be changed in the Info-Display. Vehicle personalisation ⇨ 104.

The settings can be saved for the key being used ⇨ 23.

Exit lighting

The following lights switch on if the key is removed from the ignition switch:

- interior lights
- instrument panel light (only when it is dark)
- door and console lights
- puddle lights

They will switch off automatically after a delay and will be activated again if the driver's door is opened.

Headlights, tail lights and number plate lights illuminate the surrounding area for an adjustable time after leaving the vehicle.

Path lighting

Headlights, tail lights and number plate lights illuminate the surrounding area for an adjustable time after leaving the vehicle.

Activating



1. Switch off ignition
2. Remove ignition key
3. Open driver's door
4. Pull turn signal lever
5. Close driver's door

If the driver's door is not closed, the lights switch off after two minutes.

Exit lighting is switched off immediately if the turn signal lever is pulled while the driver's door is open.

Activation, deactivation and duration of this function can be changed in the Info-Display. Vehicle personalisation ↻ 104.

The settings can be saved for the key being used ↻ 23.

Battery discharge protection

Vehicle battery state of charge function

The function guarantees longest vehicle battery life via a generator with controllable power output and optimised power distribution.

To prevent discharge of the vehicle battery when driving, the following systems are reduced automatically in two stages and finally switched off:

- auxiliary heater
- heated rear window and mirrors
- heated seats
- fan

In the second stage, a message which confirms activation of the vehicle battery discharge protection will be displayed in the Driver Information Centre.

Switching off electric lights

To prevent discharge of the vehicle battery when the ignition is switched off, some interior lights are switched off automatically after some time.

Climate control

Climate control systems	127
Heating and ventilation system	127
Air conditioning system	128
Electronic climate control system	130
Auxiliary heater	134
Air vents	135
Adjustable air vents	135
Fixed air vents	135
Maintenance	135
Air intake	135
Pollen filter	135
Air conditioning regular operation	136
Service	136

Climate control systems

Heating and ventilation system



Controls for:

- temperature
- air distribution
- fan speed
- demisting and defrosting



Heated rear window  ⇨ 35.

Temperature

red : warm
blue : cold

Heating will not be fully effective until the engine has reached normal operating temperature.

Air distribution

-  : to windscreen and front door windows
-  : to head area via adjustable air vents
-  : to foot well and windscreen

All combinations are possible.

Fan speed

Adjust the air flow by switching the fan to the desired speed.

Demisting and defrosting



- Press : fan automatically switches to higher speed, the air distribution is directed towards the windscreen.
- Set temperature control to warmest level.
- Switch on heated rear window .
- Open side air vents as required and direct them towards the door windows.

Air conditioning system



In addition to the heating and ventilation system, the air conditioning system has controls for:

- : cooling
- : air recirculation

Heated seats ↗ 55, Heated steering wheel ↗ 79.

Cooling



Press to switch on cooling. The LED in the button illuminates to indicate activation. Cooling is only functional when the engine is running and climate control fan is switched on.

Press again to switch off cooling.

The air conditioning system cools and dehumidifies (dries) as soon as the outside temperature is slightly above the freezing point. Therefore condensation may form and drip from under the vehicle.

If no cooling or drying is required, switch off the cooling system for fuel saving reasons. Activated cooling may inhibit Autostops.

Stop-start system ↗ 140.

Air recirculation system



Press  to activate air recirculation mode. The LED in the button illuminates to indicate activation.

Press  again to deactivate air recirculation mode.

Warning



The exchange of fresh air is reduced in air recirculation mode. In operation without cooling the air humidity increases, so the windows may mist up from inside. The quality of the passenger compartment air deteriorates, which may cause the vehicle occupants to feel drowsy.

In warm and very humid ambient air conditions, the windscreen may mist up from outside, when cold air is directed towards it. If windscreen mists up from outside, activate windscreen wiper and deactivate .

Maximum cooling





Briefly open the windows so that hot air can disperse quickly.



- Switch on cooling .
- Air recirculation system  on.
- Press air distribution switch .
- Set temperature control to coldest level.
- Set fan speed to highest level.
- Open all vents.



Demisting and defrosting the windows





- Press ; fan automatically switches to higher speed, the air distribution is directed towards the windscreen.
- Set temperature control to warmest level.
- Switch on heated rear window .
- Open side air vents as required and direct them towards the door windows.

Note

If  is pressed while the engine is running, an Autostop will be inhibited until  is pressed again.

If  is pressed with the fan switched on and the engine running, an Autostop will be inhibited until  is pressed again or until the fan is switched off.

If  is pressed while the engine is in an Autostop, the engine will restart automatically.

If  is pressed with the fan switched on while the engine is in an Autostop, the engine will restart automatically.

Stop-start system  140.

Electronic climate control system



The dual zone climate control allows different climatisation temperatures for driver side and front passenger side.









In automatic mode, temperature, fan speed and air distribution are regulated automatically.



Controls for:

- temperature on driver side
- air distribution
- fan speed
- temperature on front passenger side

-  : cooling
- AUTO** : automatic mode
-  : manual air recirculation
-  : demisting and defrosting

Heated rear window   35, Heated seats   55, Ventilated seats   55, Heated steering wheel   79.

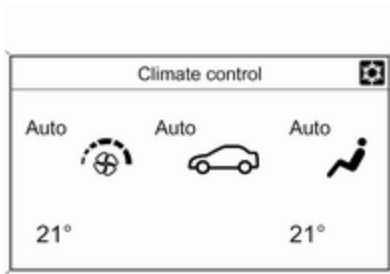

Climate control settings are shown on the Graphic-Info-Display, or depending on the version, on Colour-Info-Display. Setting modifications are briefly popped-up in both displays, superimposed over the currently displayed menu.

The electronic climate control system is only fully operational when the engine is running.

Automatic mode AUTO



Basic setting for maximum comfort:

- Press **AUTO**; the air distribution and fan speed are regulated automatically.
- Open all air vents to allow optimised air distribution in automatic mode.

- Press to switch on optimal cooling and demisting. The LED in the button illuminates to indicate activation.
- Set the preselected temperatures for driver and front passenger using the left and right rotary knobs. Recommended temperature is 22 °C.

When the soft top is opened, the Climate control adapts the automatic mode to the changed climatic environment.

The fan speed regulation in automatic mode can be changed in the Settings menu.

Vehicle personalisation ⇨ 104.

Temperature preselection

Set temperatures to the desired value.



If the minimum temperature **Lo** is set, the climate control system runs at maximum cooling, if cooling is switched on.

If the maximum temperature **Hi** is set, the climate control system runs at maximum heating.

Note

If is switched on, reducing the set cabin temperature can cause the engine to restart from an Autostop or inhibit an Autostop.

Stop-start system ⇨ 140.

Demisting and defrosting the windows



- Press . The LED in the button illuminates to indicate activation.
- Temperature and air distribution are set automatically and the fan runs at high speed.
- Switch on heated rear window .
- To return to previous mode: press . To return to automatic mode: press **AUTO**.

Setting of automatic rear window heating can be changed in the Settings menu in the Info-Display. Vehicle personalisation ⇨ 104.

Note

If is pressed while the engine is running, an Autostop will be inhibited until is pressed again.

If is pressed with the fan switched on and the engine running, an Autostop will be inhibited until is pressed again or until the fan is switched off.

If is pressed while the engine is in an Autostop, the engine will restart automatically.

If is pressed with the fan switched on while the engine is in an Autostop, the engine will restart automatically.

Stop-start system ⇨ 140.

Manual settings

Climate control system settings can be changed by activating the buttons and rotary knobs as follows. Changing a setting will deactivate the automatic mode.

Fan speed



Press lower button to decrease or upper button to increase fan speed as shown in the illustration. The fan speed is indicated by the number of segments in the display.

Pressing the lower button for longer: fan and cooling are switched off.

Pressing the upper button for longer: the fan runs at maximum speed.

To return to automatic mode: Press **AUTO**.

Air distribution , ,



Press appropriate button for desired adjustment. Activation is indicated by illumination of the LED in the button.

 : to windscreen and front door windows (air conditioning is activated in the background to help preventing windows from fogging)

 : to head area via adjustable air vents

 : to foot well and windscreen

All combinations are possible.

Return to Automatic air distribution: press **AUTO**.

Cooling



Press  to switch on cooling. The LED in the button illuminates to indicate activation. Cooling is only functional when the engine is running and climate control fan is switched on.

Press  again to switch off cooling.

The air conditioning system cools and dehumidifies (dries) when outside temperature is above a specific level. Therefore condensation may form and drip from under the vehicle.

If no cooling or drying is required, switch off the cooling system for fuel saving reasons. When the cooling system is switched off, no engine

restart will be requested by the climate control system during an Autostop. Exception: defrost system is activated and outside temperature above 0 °C.

Stop-start system ⇨ 140.

The display will indicate **ACON** when cooling is activated or **ACOFF** when the cooling is deactivated.

Activation or deactivation of cooling operation after engine start can be changed in the Settings menu in the Info-Display. Vehicle personalisation ⇨ 104.

Air recirculation mode



Press  to activate air recirculation mode. The LED in the button illuminates to indicate activation.

Press  again to deactivate recirculation mode.

Warning

The exchange of fresh air is reduced in air recirculation mode. In operation without cooling the air humidity increases, so the windows may mist up from inside. The quality of the passenger compartment air deteriorates, which may cause the vehicle occupants to feel drowsy.

In warm and very humid ambient air conditions, the windscreen may mist up from outside when cold air is directed towards it. If windscreen mists up from outside, activate windscreen wiper and deactivate .

Basic settings

Some settings can be changed in the Settings menu in the Info-Display. Vehicle personalisation ⇨ 104.

Auxiliary heater

Air heater

Quickheat is an electric auxiliary air heater which automatically warms up the passenger compartment more quickly.

Air vents

Adjustable air vents

At least one air vent must be open while the cooling is on.



To open the vent, turn the adjuster wheel towards the bigger ■ symbol. Adjust the air amount at the vent outlet by turning the adjuster wheel.



Direct the flow of air by tilting and swivelling the slats.

To close the vent, turn the adjuster wheel towards the smaller ■ symbol.

⚠ Warning

Do not attach any objects to the slats of the air vents. Risk of damage and injury in case of an accident.

Fixed air vents

Additional air vents are located beneath the windscreen and door windows and in the foot wells.

Maintenance

Air intake

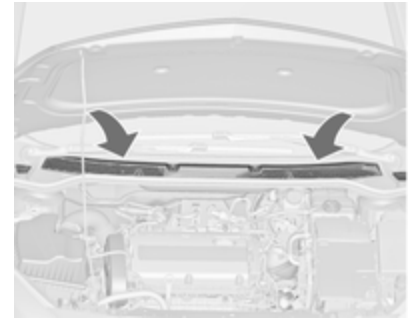

The air intake in front of the windscreen in the engine compartment must be kept clear to allow air intake. Remove any leaves, dirt or snow.

Pollen filter

The pollen filter cleans dust, soot, pollen and spores from the air entering the vehicle through the air intake.

Air conditioning regular operation

In order to ensure continuously efficient performance, cooling must be operated for a few minutes once a month, irrespective of the weather and time of year. Operation with cooling is not possible when the outside temperature is too low.

Service

For optimal cooling performance, it is recommended to annually check the climate control system, starting three years after initial vehicle registration, including:

- functionality and pressure test
- heating functionality
- leakage check
- check of drive belts
- cleaning of condenser and evaporator drainage
- performance check

Note

Refrigerant R-134a contains fluorinated greenhouse gases.

Driving and operating

Driving hints	138		
Control of the vehicle	138		
Steering	138		
Ground clearance	138		
Starting and operating	139		
New vehicle running-in	139		
Ignition switch positions	139		
Retained power off	139		
Starting the engine	139		
Overrun cut-off	140		
Stop-start system	140		
Parking	142		
Engine exhaust	144		
Exhaust filter	144		
Catalytic converter	145		
AdBlue	145		
Automatic transmission	148		
Transmission display	148		
Selector lever	149		
Manual mode	150		
Electronic driving programmes	150		
Fault	151		
Interruption of power supply	151		
Manual transmission	152		
Brakes	152		
Antilock brake system	152		
Parking brake	153		
Brake assist	155		
Hill start assist	155		
Ride control systems	155		
Traction Control system	155		
Electronic Stability Control	156		
Interactive driving system	157		
Driver assistance systems	159		
Cruise control	159		
Speed limiter	161		
Forward collision alert	162		
Following distance indication ...	164		
Parking assist	165		
Side blind spot alert	172		
Rear view camera	174		
Traffic sign assistant	176		
Lane departure warning	179		
Fuel	180		
Fuel for petrol engines	180		
Fuel for diesel engines	182		
Refuelling	182		
Trailer hitch	185		
General information	185		
Driving characteristics and towing tips	185		
		Trailer towing	185
		Towing equipment	186

Driving hints

Control of the vehicle

Never coast with engine not running (except during Autostop)

Many systems will not function in this situation (e.g. brake servo unit, power steering). Driving in this manner is a danger to yourself and others. All systems function during an Autostop, but there will be a controlled reduction in power steering assist and vehicle speed is reduced.

Stop-start system ⇨ 140.

Idle boost

If charging of the battery is required due to battery condition, the power output of the generator has to be increased. This will be achieved by an idle boost which may be audible. A message is displayed in the Driver Information Centre.

Pedals

To ensure the pedal travel is uninhibited, there must be no mats in the area of the pedals.

Use only floor mats, which fit properly and are fixed by the retainers on the driver's side.

Steering

If power steering assist is lost because the engine stops or due to a system malfunction, the vehicle can be steered but may require increased effort.

Control indicator ⚠ ⇨ 93.

Caution

Vehicles equipped with hydraulic power steering:

If the steering wheel is turned until it reaches the end of its travel, and is held in that position for more than 15 seconds, damage may occur to the power steering system and there may be loss of power steering assist.

Ground clearance

Due to the reduced ground clearance, the vehicle can be damaged depending on the vehicle loading and appearance of the ground. Take special care and drive slowly on steep driveways, entry and exit of parking garages, high kerbs and uneven surfaces. If possible, drive diagonally with one wheel after another when running over kerbs or uneven surfaces.

Starting and operating

New vehicle running-in

Do not brake unnecessarily hard for the first few journeys.

During the first drive, smoke may occur because of wax and oil evaporating off the exhaust system. Park the vehicle in the open for a while after the first drive and avoid inhaling the fumes.

During the running-in period fuel and engine oil consumption may be higher and the cleaning process of the exhaust filter may take place more often. Autostop may be inhibited to allow for charging the vehicle battery. Exhaust filter ↪ 144.

Ignition switch positions

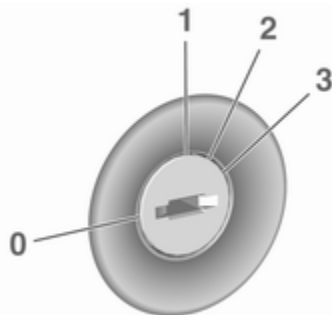

- 0 : ignition off
- 1 : steering wheel lock released, ignition off
- 2 : ignition on, for diesel engine: preheating
- 3 : starting

Retained power off

The following electronic systems can work until the driver's door is opened or for a maximum of 10 minutes after the ignition is switched off:

- power windows
- power outlets

Starting the engine

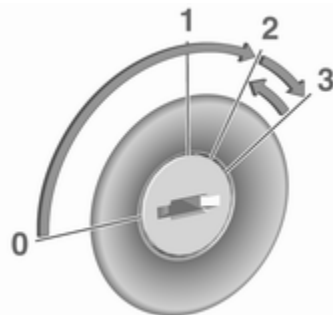

Manual transmission: operate clutch.
Automatic transmission: operate brake and move the selector lever to **P** or **N**.

Do not operate the accelerator pedal.
Diesel engine: turn the key to position **2** for preheating until control indicator  extinguishes.

Turn the key briefly to position **3** and release: an automatic procedure operates the starter with a short delay as long as the engine is running, see 'Automatic Starter Control'.

Before restarting or to switch off the engine, turn the key back to position **0**.

During an Autostop, the engine can be started by depressing the clutch pedal.

Starting the vehicle at low temperatures

Starting the engine without additional heaters is possible down to -25 °C for diesel engines and -30 °C for petrol engines. Required is an engine oil with the correct viscosity, the correct fuel, performed services and a sufficiently charged vehicle battery. With temperatures below -30 °C the automatic transmission needs a warming phase of approx. 5 minutes. The selector lever must be in position **P**.

Automatic Starter Control

This function controls the engine starting procedure. The driver does not have to hold the key in position **3**. Once applied, the system will go on starting automatically until the engine

is running. Because of the checking procedure, the engine starts running after a short delay.

Possible reasons for a non-starting engine:

- Clutch pedal not operated (manual transmission).
- Brake pedal not operated or selector lever not in **P** or **N** (automatic transmission).
- Timeout occurred.

Turbo engine warm-up

Upon start-up, engine available torque may be limited for a short time, especially when the engine temperature is cold. The limitation is to allow the lubrication system to fully protect the engine.

Overrun cut-off

The fuel supply is automatically cut off during overrun, i.e. when the vehicle is driven with a gear engaged but accelerator pedal is released.

Depending on driving conditions, the overrun cut-off may be deactivated.

Stop-start system

The stop-start system helps to save fuel and to reduce the exhaust emissions. When conditions allow, it switches off the engine as soon as the vehicle is at a low speed or at a standstill, e.g. at a traffic light or in a traffic jam. It starts the engine automatically as soon as the clutch is depressed. A vehicle battery sensor ensures that an Autostop is only performed if the vehicle battery is sufficiently charged for a restart.

Activation

The stop-start system is available as soon as the engine is started, the vehicle starts-off and the conditions as stated below in this section are fulfilled.

Deactivation



Deactivate the stop-start system manually by pressing **eco**. The deactivation is indicated when the LED in the button extinguishes.

Autostop

If the vehicle is at a low speed or at a standstill, activate an Autostop as follows:

- Depress the clutch pedal.
- Move the selector lever to neutral.
- Release the clutch pedal.

The engine will be switched off while the ignition stays on.



An Autostop is indicated by the needle at the **AUTOSTOP** position in the tachometer.

The stop-start system will be disabled on inclines of 12% or more.

During an Autostop, the heating and brake performance will be maintained.

Caution

The power steering assist may be reduced during an Autostop.

Conditions for an Autostop

The stop-start system checks if each of the following conditions is fulfilled:

- The stop-start system is not manually deactivated.
- The bonnet is fully closed.
- The driver's door is closed or the driver's seat belt is fastened.
- The vehicle battery is sufficiently charged and in good condition.
- The engine is warmed up.
- The engine coolant temperature is not too high.
- The engine exhaust temperature is not too high, e.g. after driving with high engine load.
- The ambient temperature is above $-5\text{ }^{\circ}\text{C}$.
- The climate control system allows an Autostop.
- The brake vacuum is sufficient.
- The self-cleaning function of the exhaust filter is not active.
- The vehicle was driven at least at walking speed since the last Autostop.

Otherwise an Autostop will be inhibited.

Certain settings of the climate control system may inhibit an Autostop. See 'Climate control' chapter for more details ⇨ 130.

Immediately after motorway driving, an Autostop may be inhibited.

New vehicle running-in ⇨ 139.

Vehicle battery discharge protection

To ensure reliable engine restarts, several battery discharge protection features are implemented as part of the stop-start system.

Power saving measures

During an Autostop, several electrical features such as auxiliary electric heater or rear window heating are disabled or switched to a power saving mode. The fan speed of the climate control system is reduced to save power.

Restart of the engine by the driver

Depress the clutch pedal to restart the engine.

The engine start is indicated by the needle at the idle speed position in the tachometer.

If the selector lever is shifted out of neutral before depressing the clutch first, control indicator  illuminates or is shown as a symbol in the Driver Information Centre.

Control indicator  ⇨ 92.

Restart of the engine by the stop-start system

The selector lever must be in neutral to enable an automatic restart.

If one of the following conditions occurs during an Autostop, the engine will be restarted automatically by the stop-start system:

- The stop-start system is manually deactivated.
- The bonnet is opened.
- The driver's seat belt is unfastened and the driver's door is opened.
- The engine temperature is too low.

- The charging level of the vehicle battery is below a defined level.
- The brake vacuum is not sufficient.
- The vehicle is driven at least at walking speed.
- The climate control system requests an engine start.
- The air conditioning is manually switched on.

If the bonnet is not fully closed, a warning message is displayed in the Driver Information Centre.

If an electrical accessory, e.g. a portable CD player, is connected to the power outlet, a brief power drop during restart might be noticeable.

Parking

Warning

- Do not park the vehicle on an easily ignitable surface. The high temperature of the exhaust system could ignite the surface.

- Always apply the parking brake. Activate the manual parking brake without pressing the release button. Apply as firmly as possible on a downhill slope or uphill slope. Depress brake pedal at the same time to reduce operating force.

For vehicles with electric parking brake, pull switch (P) for approx. one second.

The electric parking brake is applied when control indicator (P) illuminates ⇨ 92.

- Switch off the engine.
- If the vehicle is on a level surface or uphill slope, engage first gear or set the selector lever to position **P** before removing the ignition key. On an uphill slope, turn the front wheels away from the kerb.

If the vehicle is on a downhill slope, engage reverse gear or set the selector lever to position **P** before removing the ignition

key. Turn the front wheels towards the kerb.

- Close the windows and the soft top.
- Remove the ignition key. Turn the steering wheel until the steering wheel lock is felt to engage.

For vehicles with automatic transmission, the key can only be removed when the selector lever is in position **P**.

- Lock the vehicle.
- Activate the anti-theft alarm system.
- The engine cooling fans may run after the engine has been switched off ⇨ 192.

Caution

After running at high engine speeds or with high engine loads, operate the engine briefly at a low load or run in neutral for

approx. 30 seconds before switching off, in order to protect the turbocharger.

Note

In the event of an accident with airbag deployment, the engine is turned off automatically if the vehicle comes to a standstill within a certain time.

Engine exhaust

Danger

Engine exhaust gases contain poisonous carbon monoxide, which is colourless and odourless and could be fatal if inhaled.

If exhaust gases enter the interior of the vehicle, open the windows. Have the cause of the fault rectified by a workshop.

Avoid driving with an open load compartment, otherwise exhaust gases could enter the vehicle.

Exhaust filter

The exhaust filter is a particle filter for diesel and gasoline engines.

Automatic cleaning process

The exhaust filter system filters harmful soot particles out of the exhaust gases. The system includes a self-cleaning function that runs automatically during driving without any notification. The filter is cleaned by periodically burning off the soot particles at high temperature. This process takes place automatically under set driving conditions and may take up to 25 minutes. Typically it needs between seven and twelve minutes. Autostop is not available and fuel consumption may be higher during this period. The emission of smells and smoke during this process is normal.

System requires cleaning

Under certain conditions, e.g. driving short distances, the system cannot clean itself automatically.

If cleaning of the filter is required and if previous driving conditions did not enable automatic cleaning, it will be indicated by illumination of  and a warning message in the Driver Information Centre.

 illuminates along with a warning message when exhaust filter is full. Start cleaning process as soon as possible.

 flashes along with a warning message when exhaust filter has reached the maximum filling level. Start cleaning process immediately to avoid damage to the engine.

Activate self-cleaning process

To activate cleaning process, continue driving, keep engine speed above 2000 rpm. Shift down if necessary. Exhaust filter cleaning is then started.

Cleaning process is completed more quickly at high engine speeds and loads.

Control indicator  extinguishes as soon as the self-cleaning operation is complete. Keep on driving until self-cleaning operation is complete.

Caution

If possible, do not interrupt cleaning process. Drive until cleaning is completed to avoid the need for service or repair by a workshop.

Cleaning process not possible

If cleaning is not possible for any reason, control indicator  illuminates and a warning message appears in the Driver Information Centre. Engine power may be reduced. Seek the assistance of a workshop immediately.

Catalytic converter

The catalytic converter reduces the amount of harmful substances in the exhaust gases.

Caution

Fuel grades other than those listed on pages ↻ 180, ↻ 244 could damage the catalytic converter or electronic components.

Unburnt petrol will overheat and damage the catalytic converter. Therefore avoid excessive use of the starter, running the fuel tank dry and starting the engine by pushing or towing.

In the event of misfiring, uneven engine running, a reduction in engine performance or other unusual problems, have the cause of the fault rectified by a workshop as soon as possible. In an emergency, driving can be continued for a short period, keeping vehicle speed and engine speed low.

AdBlue

General information

The selective catalytic reduction (BlueInjection) is a method to substantially reduce the nitrogen oxides in the exhaust emission. This is achieved by injecting a Diesel Exhaust Fluid (DEF) into the exhaust system. The ammonia released by the fluid reacts with nitrous gases (NO_x) from the exhaust and turns it into nitrogen and water.

The designation of this fluid is AdBlue®. It is a non-toxic, non-flammable, colourless and odourless fluid which consists of 32% urea and 68% water.

Warning

Avoid contact of your eyes or skin with AdBlue.

In case of eye or skin contact, rinse off with water.

Caution
Avoid contact of the paintwork with AdBlue.
In case of contact, rinse off with water.

AdBlue freezes at a temperature of approx. -11 °C. As the vehicle is equipped with an AdBlue pre-heater, the emissions reduction at low temperatures is ensured. The AdBlue pre-heater works automatically.

The typical AdBlue consumption is approx. two litres per 1000 km, but can also be higher depending on driving behaviour (e.g. high load or towing).

AdBlue tank

At a remaining volume of approx. five litres, there is a liquid level switch. Warning messages are displayed only below that threshold.

Tank volume ⇨ 247.

Level warnings

Depending on the calculated range of AdBlue, different messages are displayed in the Driver Information Centre. The messages and the restrictions are a legal requirement.

The first possible warning is **AdBlue Range: 2400 km**.

This warning will show up once briefly with the calculated range. Driving is possible without any restrictions.

The next warning level is entered with a range below 1750 km. The message with the current range will always be displayed when ignition is switched on and needs to be confirmed ⇨ 96. Refill AdBlue before entering the next warning level.

At an AdBlue range below 900 km, the following warning messages are alternately displayed and cannot be dismissed:

- **AdBlue Low Refill Now**
- **Engine Restart Prevented in 900 km.**

Additionally, control indicator  flashes continuously.

Note

In case of high AdBlue consumption, the Driver Information Centre may display this warning without the previous warning stages.

The last warning level is entered when the AdBlue tank is empty. Restart of the engine is not possible. The following warning messages are alternately displayed and cannot be dismissed:

- **AdBlue Empty Refill Now**
- **Engine Will Not Restart.**

Additionally, control indicator  flashes continuously.

With active prevention of an engine start, the following message will be displayed:

Refill AdBlue To Start Vehicle.

The tank must be refilled completely with AdBlue, otherwise restarting of the engine is not possible.

High emission warnings

If the exhaust emission rises above a certain value, warnings similar to the range warnings will be displayed in the Driver Information Centre.

Requests to have the exhaust system checked and finally the announcement of the prevention of an engine restart are displayed. These restrictions are a legal requirement.

Consult a workshop for assistance.

Refilling AdBlue

Caution

Only use AdBlue that complies with European standards DIN 70 070 and ISO 22241-1.

Do not use additives.

Do not dilute AdBlue.

Otherwise the selective catalytic reduction system could be damaged.

Note

Whenever a filling pump with a nozzle for passenger cars is not available at a filling station, use only AdBlue bottles or canisters with a sealed refill adapter for refilling, to prevent splashback and overflow, and in order to ensure that the fumes from the tank are captured and do not emerge. AdBlue in bottles or canisters is available in many filling stations and can be purchased e.g. at Opel dealers and other retail outlets.

Since AdBlue has a limited durability, check the date of expiry before refilling.

Note

The refilling of AdBlue is only detected by the system when the abovementioned liquid level switch in the tank is activated.

In case AdBlue refill is not successfully detected:

1. Continuously drive the vehicle for 10 minutes making sure that vehicle speed is always higher than 20 km/h.
2. If AdBlue refill is detected successfully, AdBlue supply-driven limitations will disappear.

If AdBlue refill is still not detected, seek the assistance of a workshop.

If AdBlue must be refilled at temperatures below -11 °C, the refilling of AdBlue may not be detected by the system. In this event, park the vehicle in a space with a higher ambient temperature until AdBlue is liquefied.

Note

When unscrewing the protective cap from the filler neck, ammonia fumes may emerge. Do not inhale as the fumes have a pungent smell. The fumes are not harmful by inhalation.

The AdBlue tank should be filled completely. This must be done if the warning message regarding prevention of an engine restart is already displayed.

The vehicle must be parked on a level surface.

The filler neck for AdBlue is located behind the fuel filler flap, which is located at right rear side of the vehicle.

The fuel filler flap can only be opened if the vehicle is unlocked.

1. Remove key from ignition switch.
2. Close all doors to avoid ammonia fumes entering the interior of the vehicle.
3. Release the fuel filler flap by pushing the flap ↗ 182.

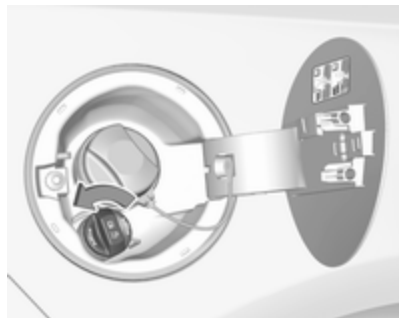

4. Unscrew protective cap from the filler neck.

5. Open AdBlue canister.
6. Mount one end of the hose on the canister and screw the other end on the filler neck.
7. Lift the canister until it is empty, or until the flow from the canister has stopped. This can take up to five minutes.
8. Place the canister on the ground to empty the hose, wait 15 seconds.
9. Unscrew the hose from the filler neck.
10. Mount the protective cap and turn clockwise until it engages.

Note

Dispose of AdBlue canister according to environmental requirements. Hose can be reused after flushing with clear water before AdBlue dries out.

Automatic transmission

The automatic transmission permits automatic gearshifting (automatic mode) or manual gearshifting (manual mode).

Manual shifting is possible in manual mode by tapping the selector lever ↗ 150.

Transmission display

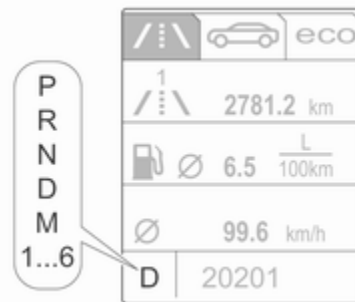

The mode or selected gear is shown in the transmission display.

In automatic mode, the driving programme is indicated by **D** in the Driver Information Centre.

In manual mode, **M** and the number of the selected gear is indicated.

R indicates reverse gear.

N indicates neutral position.

P indicates park position.

Selector lever

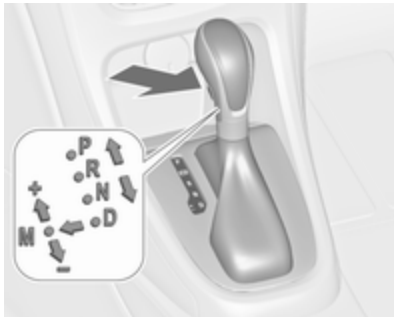

P : park position, press release button, wheels are locked, engage only when the vehicle is stationary and parking brake is applied

R : reverse gear, press release button, engage only when vehicle is stationary

N : neutral

D : automatic mode

M : manual mode: move selector lever from **D** to the left.

+ : manual mode upshifting: move selector lever in position **M** and tap upwards

- : manual mode downshifting: move selector lever in position **M** and tap rearwards

The selector lever is locked in **P** and can only be moved when the ignition is on and the brake pedal is applied.



Without brake pedal applied, the control indicator  illuminates.

If the selector lever is not in **P** when the ignition is switched off, the control indicators  and **P** flash.

To engage **P** or **R**, press the release button.

The engine can only be started with the lever in position **P** or **N**. When position **N** is selected, press the brake pedal or apply the parking brake before starting.

Do not accelerate while engaging a gear. Never depress the accelerator pedal and brake pedal at the same time.

When a gear is engaged, the vehicle slowly begins to creep when the brake is released.

Engine braking

To utilise the engine braking effect, select a lower gear in good time when driving downhill, see manual mode.

Rocking the vehicle

Rocking the vehicle is only permissible if the vehicle is stuck in sand, mud or snow. Move the selector lever between **D** and **R** in a repeat pattern. Do not race the engine and avoid sudden acceleration.

Parking

Apply the parking brake and engage **P**.

The ignition key can only be removed when the selector lever is in position **P**.

Manual mode



Move selector lever out of position **D** towards the left to select manual mode **M**.

Tap selector lever

forwards **+** : shift to a higher gear

backwards **-** : shift to a lower gear

The selected gear is indicated in the instrument cluster.

If a higher gear is selected when vehicle speed is too low, or a lower gear when vehicle speed is too high,

the shift is not executed. This can cause a message in the Driver Information Centre.

In manual mode, no automatic shifting to a higher gear takes place at high engine revolutions.

Electronic driving programmes

- Following a cold start, the operating temperature programme increases engine speed to quickly bring the catalytic converter to the required temperature.
- The automatic neutral shift function automatically shifts to idling when the vehicle is stopped with a forward gear engaged and the brake pedal is pressed.
- When SPORT mode is engaged, the vehicle shifts at higher engine speeds (unless cruise control is on). SPORT mode ↻ 157.
- Special programmes automatically adapt the shifting points when driving up inclines or down hills.

Kickdown

If the accelerator pedal is pressed down completely in automatic mode, the transmission shifts to a lower gear depending on engine speed.

Fault

In the event of a fault, a vehicle message is displayed in the Driver Information Centre. Vehicle messages ⇨ 103.

The transmission no longer shifts automatically. Continued travel is possible with manual shifting.

Only the highest gear is available. Depending on the fault, 2nd gear may also be available in manual mode. Shift only when vehicle is at a standstill.

Have the cause of the fault remedied by a workshop.

Interruption of power supply

In the event of an interruption of power supply, the selector lever cannot be moved out of the **P** position. The ignition key cannot be removed from the ignition switch.

If the vehicle battery is discharged, start the vehicle using jump leads ⇨ 228.

If the vehicle battery is not the cause of the fault, release the selector lever.

1. Apply the parking brake.



2. Release the selector lever trim from the centre console at the front, fold it upwards and rotate it to the left.

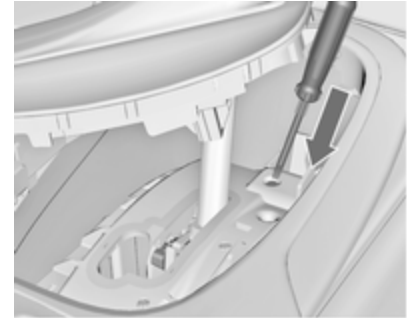

3. Insert a screwdriver into the opening as far as it will go and move the selector lever out of **P** or **N**. If **P** or **N** is engaged again, the selector lever will be locked in position again. Have the cause of the power supply interruption remedied by a workshop.
4. Mount the selector lever trim onto the centre console and refit.

Manual transmission



To engage reverse, with the vehicle stationary, depress clutch pedal, press the release button on the selector lever and engage the gear.

If the gear does not engage, set the lever to neutral, release the clutch pedal and depress again; then repeat gear selection.

Do not slip the clutch unnecessarily.

When operating, depress the clutch pedal completely. Do not use the pedal as a foot rest.

Caution

It is not advisable to drive with the hand resting on the selector lever.

Upshift indication ⇨ 93.

Brakes

The brake system comprises two independent brake circuits.

If a brake circuit fails, the vehicle can still be braked using the other brake circuit. However, braking effect is achieved only when the brake pedal is depressed firmly. Considerably more force is needed for this. The braking distance is extended. Seek the assistance of a workshop before continuing your journey.

When the engine is not running, the support of the brake servo unit disappears once the brake pedal has been depressed once or twice. Braking effect is not reduced, but braking requires significantly greater force. It is especially important to bear this in mind when being towed.

Control indicator (D) ⇨ 92.

Antilock brake system

Antilock brake system (ABS) prevents the wheels from locking.

ABS starts to regulate brake pressure as soon as a wheel shows a tendency to lock. The vehicle remains steerable, even during hard braking.

ABS control is made apparent through a pulse in the brake pedal and the noise of the regulation process.

For optimum braking, keep the brake pedal fully depressed throughout the braking process, despite the fact that the pedal is pulsating. Do not reduce the pressure on the pedal.

After starting off the system performs a self-test which may be audible.

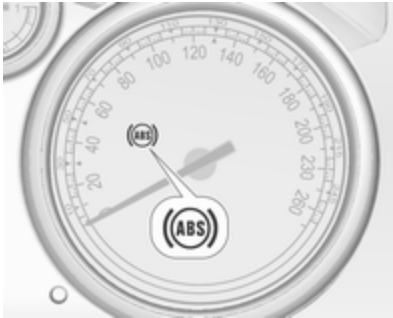

Control indicator (ABS) ↗ 93.

Adaptive brake light

During full braking, all three brake lights flash for the duration of ABS control.

Fault

⚠ Warning

If there is a fault in the ABS, the wheels may be liable to lock due to braking that is heavier than normal. The advantages of ABS are no longer available. During hard braking, the vehicle can no longer be steered and may swerve.

Have the cause of the fault remedied by a workshop.

Parking brake

Manual parking brake

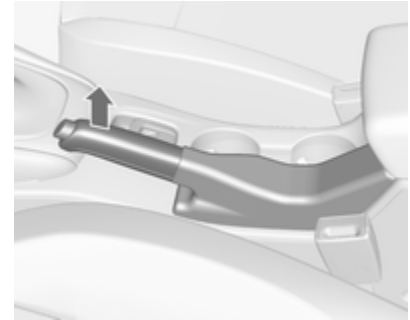

⚠ Warning

Always apply parking brake firmly without operating the release button, and apply as firmly as possible on a downhill or uphill slope.

To release the parking brake, pull the lever up slightly, press the release button and fully lower the lever.

To reduce the operating forces of the parking brake, depress the brake pedal at the same time.

Control indicator (D) ⇨ 92.

Electric parking brake

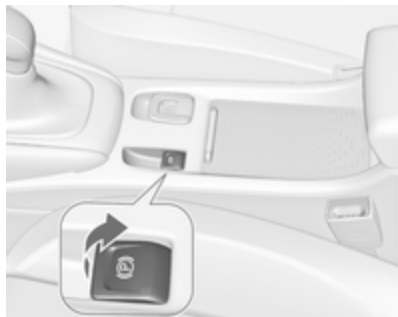

Applying when vehicle is stationary

⚠ Warning

Pull switch (E) for approx. one second, the electric parking brake operates automatically with

adequate force. For maximum force, e.g. parking with trailer or on inclines, pull switch (E) twice.

The electric parking brake is applied when control indicator (E) illuminates ⇨ 92.

The electric parking brake can always be activated, even if the ignition is off.

Do not operate electric parking brake system too often without engine running as this will discharge the vehicle battery.

Before leaving the vehicle, check the electric parking brake status. Control indicator (E) ⇨ 92.

Releasing

Switch on ignition. Keep brake pedal depressed then push switch (E).

Drive away function

Vehicles with manual transmission: Depressing the clutch pedal and then slightly releasing the clutch pedal and slightly depressing the accelerator pedal releases the electric parking

brake automatically. This is not possible when the switch (E) is pulled at the same time.

Vehicles with automatic transmission: Engaging **D** and then depressing the accelerator pedal releases the electric parking brake automatically. This is not possible when the switch (E) is pulled at the same time.

Dynamic braking when vehicle is moving

When the vehicle is moving and the switch (E) is kept pulled, the electric parking brake system will decelerate the vehicle, but will not apply statically.

As soon as the switch (E) is released, dynamic braking will be stopped.

Fault

Failure mode of electric parking brake is indicated by control indicator (E) and by a vehicle message which is displayed in the Driver Information Centre.

Apply electric parking brake: pull and hold the switch (P) for more than 5 seconds. If control indicator (P) illuminates, electric parking brake is applied.

Release electric parking brake: push and hold the switch (P) for more than 2 seconds. If control indicator (P) extinguishes, electric parking brake is released.

Control indicator (P) flashes: electric parking brake is not fully applied or released. When continuously flashing, release electric parking brake and retry applying.

Brake assist

If the brake pedal is depressed quickly and forcefully, maximum brake force is automatically applied (full braking).

Maintain steady pressure on the brake pedal for as long as full braking is required. Maximum brake force is automatically reduced when the brake pedal is released.

Hill start assist

The system helps prevent unintended movement when driving away on inclines.

When releasing the brake pedal after stopping on an incline, the brakes remain on for a further two seconds. The brakes release automatically as soon as the vehicle begins to accelerate.

The hill start assist is not active during an Autostop.

Ride control systems

Traction Control system

The Traction Control system (TC) is a component of the Electronic Stability Control (ESC) ↗ 156.

TC improves driving stability when necessary, regardless of the type of road surface or tyre grip, by preventing the drive wheels from spinning.

As soon as the drive wheels starts to spin, engine output is reduced and the wheel spinning the most is braked individually. This considerably improves the driving stability of the vehicle on slippery road surfaces.



TC is operational after each engine start as soon as the control indicator  extinguishes.

When TC operates  flashes.

Warning

Do not let this special safety feature tempt you into taking risks when driving.



Adapt speed to the road conditions.

Control indicator  ⇨ 94.

Deactivation



TC can be switched off when spinning of drive wheels is required:

Press  briefly to deactivate TC,  illuminates. Deactivation is displayed as status message in the Driver Information Centre.

TC is reactivated by pressing  again.

TC is also reactivated the next time the ignition is switched on.

Electronic Stability Control

Electronic Stability Control (ESC) improves driving stability when necessary, regardless of the type of road surface or tyre grip. It also prevents the drive wheels from spinning. ESC operates in combination with the Traction Control system (TC) ⇨ 155.

As soon as the vehicle starts to swerve (understeer/oversteer), engine output is reduced and the wheels are braked individually. This considerably improves the driving stability of the vehicle on slippery road surfaces.



ESC is operational after each engine start as soon as the control indicator  extinguishes.

When ESC operates  flashes.

Warning

Do not let this special safety feature tempt you into taking risks when driving.





Adapt speed to the road conditions.

Control indicator   94.

Deactivation



For a more sporty behaviour ESC and TC can be deactivated separately:

- Press  briefly: only Traction control system is inactive, ESC remains active,  illuminates
- Press and hold  for at least 5 seconds: TC and ESC are deactivated,  and  illuminate.

Additionally, the selected mode is displayed as status message in the Driver Information Centre.

If the vehicle comes into threshold with deactivated ESP, the system will reactivate ESP for the time duration of the threshold, when the brake pedal is depressed once.

ESC is reactivated by pressing  again. If the TC system was previously disabled, both TC and ESC are reactivated.

ESC is also reactivated the next time the ignition is switched on.

Interactive driving system

Flex Ride

Flex Ride driving system allows the driver to select between three driving modes:

- SPORT mode: press **SPORT**, LED illuminates.
- TOUR mode: press **TOUR**, LED illuminates.
- NORMAL mode: both **SPORT** and **TOUR** are not pressed, no LED illuminates.

Deactivate SPORT mode and TOUR mode by pressing corresponding button once more.

In each driving mode, Flex Ride networks the following electronic systems:

- Continuous Damping Control
- Accelerator Pedal Control
- Steering Control
- Electronic Stability Control (ESC)
- Antilock brake system (ABS) with cornering brake control
- Automatic transmission.

SPORT mode



The settings of the systems are adapted to a sportier driving style.

TOUR mode



The settings of the systems are adapted to a comfort driving style.

NORMAL mode

All settings of the systems are adapted to standard values.

Drive mode control

Within each manually selected driving mode SPORT, TOUR or NORMAL, the Drive Mode Control detects and analyses continuously the real driving characteristic, responses by the driver, and the active dynamic state of the vehicle. If necessary, the control unit of Drive Mode Control

automatically changes the settings within the selected driving mode or, when recognising greater variations, the driving mode is changed for the length of variation.

If, for example, NORMAL mode is selected and Drive Mode Control detects a sporty driving behaviour, Drive Mode Control changes several settings of the NORMAL mode into sporty settings. The Drive Mode Control changes to SPORT mode in case of very sporty driving behaviour.

If, for another example, TOUR mode is selected and whilst driving on a winding road a sudden hard brake is necessary, Drive Mode Control will detect the dynamic vehicle condition and changes the settings for suspension to SPORT mode to increase vehicle stability.

When the driving characteristic or the dynamic vehicle state returns to the former state, Drive Mode Control will change the settings to the preselected driving mode.

Personalised settings in the SPORT mode

The driver can select the functions of the SPORT mode when **SPORT** is pressed. These settings can be changed in the Settings menu in the Info-Display. Vehicle personalisation ↗ 104.

Driver assistance systems

⚠ Warning

Driver assistance systems are developed to support the driver and not to replace the driver's attention.

The driver accepts full responsibility when driving the vehicle.

When using driver assistance systems, always take care regarding the current traffic situation.

Cruise control

The cruise control can store and maintain speeds of approx. 30 to 200 km/h. Deviations from the stored speeds may occur when driving uphill or downhill.

For safety reasons, the cruise control cannot be activated until the brake pedal has been operated once. Activating in first gear is not possible.



Do not use the cruise control if it is not advisable to maintain a constant speed.

With automatic transmission, only activate cruise control in automatic mode.

Control indicator ⚡ ↗ 96.

Switching on

Press ⚡; control indicator ⚡ in instrument cluster illuminates white.

Activation

Accelerate to the desired speed and turn thumb wheel to **SET/-**, the current speed is stored and

maintained. Control indicator  in instrument cluster illuminates green. Accelerator pedal can be released.

Vehicle speed can be increased by depressing the accelerator pedal. When the accelerator pedal is released, the previously stored speed is resumed.

Cruise control remains activated while gearshifting.

Increase speed

With cruise control active, hold thumb wheel turned to **RES/+** or briefly turn to **RES/+** repeatedly: speed increases continuously or in small increments.



Alternatively accelerate to the desired speed and store by turning to **SET/-**.



Reduce speed

With cruise control active, hold thumb wheel turned to **SET/-** or briefly turn to **SET/-** repeatedly: speed decreases continuously or in small increments.

Deactivation

Press ; control indicator  in instrument cluster illuminates white. Cruise control is deactivated. Last stored speed remains in memory for later speed resume.



Automatic deactivation:

- Vehicle speed below approx. 30 km/h.
- Vehicle speed above approx. 200 km/h.
- The brake pedal is depressed.
- The clutch pedal is depressed for a few seconds.
- Selector lever is in **N**.
- Engine speed is in a very low range.
- The Traction Control system (TC) or Electronic Stability Control (ESC) is operating.

Resume stored speed

Turn thumb wheel to **RES/+** at a speed above 30 km/h. The stored speed will be obtained.

Switching off

Press ; control indicator  in instrument cluster extinguishes. The stored speed is deleted.

Pressing  for activating speed limiter or switching off the ignition also switches off cruise control and deletes the stored speed.

Speed limiter

The speed limiter prevents the vehicle exceeding a preset maximum speed.



The maximum speed can be set at a speed above 25 km/h.

The driver can only accelerate up to the preset speed. Deviations from the limited speed may occur when driving downhill.

The preset speed limit is displayed in the top line of the Driver Information Centre when the system is active.

Activation



Press . If cruise control has been activated before, it is switched off when speed limiter is activated and control indicator  extinguishes.

Set speed limit

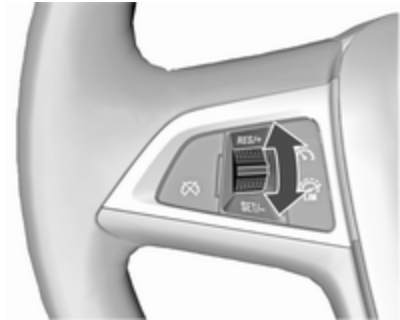

With speed limiter active, hold thumb wheel turned to **RES/+** or briefly turn to **RES/+** repeatedly until the desired maximum speed is displayed in the Driver Information Centre.

Alternatively, accelerate to the desired speed and briefly turn thumb wheel to **SET/-**: the current speed is stored as maximum speed. Speed limit is displayed in the Driver Information Centre.



Change speed limit

With speed limiter active, turn thumb wheel to **RES/+** to increase or **SET/-** to decrease the desired maximum speed.

Exceeding the speed limit

In the event of an emergency, it is possible to exceed the speed limit by depressing the accelerator pedal firmly beyond the point of resistance.

The limited speed will flash in the Driver Information Centre and, depending on the vehicle, additionally a chime sounds during this period.

Release the accelerator pedal and the speed limiter function is reactivated once a speed lower than the limit speed is obtained.

Deactivation

Press : speed limiter is deactivated and the vehicle can be driven without speed limit.

The limited speed is stored and a corresponding message appears in the Driver Information Centre.

Resume limit speed

Turn thumb wheel to **RES/+**. The stored speed limit will be obtained.

Switching off

Press , the speed limit indication in the Driver Information Centre extinguishes. The stored speed is deleted.

By pressing  to activate cruise control or by switching off the ignition, speed limiter is also deactivated and the stored speed is deleted.

Forward collision alert

The forward collision alert can help to avoid or reduce the harm caused by front-end crashes.

Forward collision alert uses the front camera system in the windscreen to detect a vehicle directly ahead, in your path, within a distance of approx. 60 metres.



A vehicle ahead is indicated by control indicator .



If a vehicle directly ahead is approached too quickly, a warning chime and alert in the Driver Information Centre is provided.

A precondition is that forward collision alert is not deactivated by pressing .



Activation

Forward collision alert operates automatically above 40 km/h, if it is not deactivated by pressing , see below.

Selecting the alert sensitivity

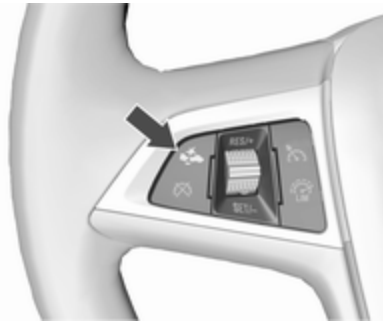
The alert sensitivity can be set to near, medium or far.



Press , the current setting is shown on the Driver Information Centre. Press  again to change the alert sensitivity.

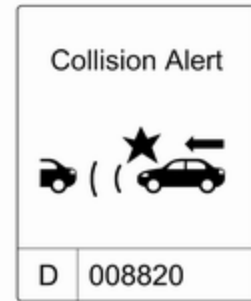

Alerting the driver

A green illuminated vehicle ahead control indicator  illuminates in the instrument cluster when the system has detected a vehicle in the driving path.



When the distance to a preceding moving vehicle gets too small or when approaching another vehicle too rapidly and a collision is imminent, the collision alert symbol pops-up in the Driver Information Centre.

Simultaneously a warning chime sounds. Depress the brake pedal, if it is required by the situation.

Deactivation

The system can be deactivated. Press  repeatedly until the following message appears in the Driver Information Centre.

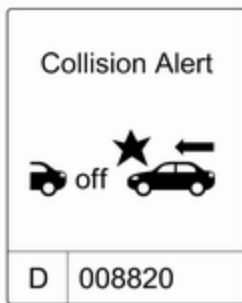

General information

Warning

Forward collision alert is just a warning system and does not apply the brakes. When approaching a vehicle ahead too rapidly, it may not provide you enough time to avoid a collision.

The driver accepts full responsibility for the valid following distance based on traffic, weather and visibility conditions.

The complete attention of the driver is always required while driving. He shall always be ready to take action and apply the brakes.

System limitations

The system is designed to warn only for vehicles, but may react also on other objects.

In the following cases, forward collision alert may not detect a vehicle ahead or sensor performance is limited:

- On winding roads.
- When weather limits visibility, e.g. fog, rain, or snow.
- When the sensor is blocked by snow, ice, slush, mud, dirt, or windscreen damage.

Following distance indication

The following distance indication displays the distance to a preceding moving vehicle. The front camera in

the windscreen is used to detect the distance of a vehicle directly ahead in the vehicle's path. It is active at speeds above 40 km/h.

When a preceding vehicle is detected ahead, the distance is indicated in seconds, displayed on a page in the Driver Information Centre ↗ 96. Press **MENU** on the turn signal lever to select **Vehicle Information Menu**  and turn the adjuster wheel to choose following distance indication page.



The minimum indicated distance is 0.5 seconds.

If there is no vehicle ahead or the vehicle ahead is out of range, two dashes will be displayed: -- s.

Parking assist

Rear parking assist

Warning

The driver bears full responsibility for the parking manoeuvre.

Always check the surrounding area while reversing and using the rear parking assist system.

The rear parking assist makes parking easier by measuring the distance between the vehicle and rear obstacles. It informs and warns the driver by giving acoustic signals.



The system has four ultrasonic parking sensors in the rear bumper.

Activation

When reverse gear is engaged, the system is ready to operate automatically.

An illuminated LED in the parking assist button **P**  indicates that the system is ready to operate.

Indication

The system warns the driver with acoustic signals against potentially hazardous obstacles behind the vehicle. The interval between the sounds becomes shorter as the

vehicle gets closer to that obstacle. When the distance is less than approx. 30 cm, the sound is continuous.

Additionally, the distance to obstacles can be shown in the Driver Information Centre.

Deactivation



The system automatically switches off when reverse gear is disengaged. To switch on the system again, engage reverse gear.

Manual deactivation is also possible by pressing the parking assist button .

When the system is deactivated, the LED in the button extinguishes.

Additionally, **Park Assist Off** pops-up in the Driver Information Centre when the system is deactivated manually.

Fault

In the event of a fault in the system or if the system does not work due to temporary conditions like ice covered sensors, a message is displayed in the Driver Information Centre.

Vehicle messages ↪ 103.

Front-rear parking assist

Warning

The driver bears full responsibility for the parking manoeuvre.

Always check the surrounding area when driving backwards or forwards while using parking assist system.

The front-rear parking assist measures the distance between the vehicle and obstacles in front and

behind the vehicle. The system gives acoustic signals and display messages.



The system has four ultrasonic parking sensors each in the rear and front bumper.

It uses two different acoustic warning signals for the front and rear monitoring areas, each with a different tone frequency. The signal for front obstacles sounds via the front speakers, for rear obstacles it sounds via the rear speakers.

Parking assist button and operation logic



Front-rear parking assist is equipped with **P**▲. If the vehicle is additionally equipped with advanced parking assist (see the following separate description) the system is equipped with **P**▣. Both systems will be operated by pressing **P**▣.

Short press of **P**▲ or **P**▣ deactivates or activates the front parking assist.

Long press of **P**▣ (approx. one second) activates or deactivates the advanced parking assist.

Button logic to operate the systems is as follows:

- Front-rear parking assist is active: short press deactivates front-rear parking assist.
- Front-rear parking assist is active: long press activates advanced parking assist if a forward gear is engaged.
- Advanced parking assist is active: short press activates front-rear parking assist.
- Advanced parking assist is active: long press deactivates advanced parking assist.
- Advanced parking assist and front-rear parking assist are active: short press deactivates both systems.

Activation

When reverse gear is engaged, the front and rear parking assist is ready to operate.

The front parking assist is also activated automatically at a speed up to 11 km/h.

An illuminated LED in the parking assist button **P**▲ or **P**▣ indicates that the system is ready to operate.

If the vehicle exceeds a speed of 11 km/h, the front parking assist is deactivated. The front parking assist is always reactivated when vehicle speed drops below 11 km/h.

Indication

The system warns the driver with acoustic signals against potentially hazardous obstacles behind and in front of the vehicle. Depending on which side of the vehicle is closer to an obstacle, you will hear acoustic warning signals on the respective side of the vehicle. The interval between the sounds becomes shorter as the vehicle gets closer to that obstacle. When the distance is less than approx. 30 cm, the sound is continuous.

Additionally, the distance to obstacles is shown in the Driver Information Centre ↗ 96.

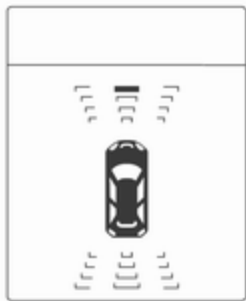

The distance to a front and rear obstacle is indicated by changing distance lines around the vehicle.

Rear obstacles are indicated acoustically and visually at the same time.

Front obstacles are indicated visually first. At distances less than 80 cm an acoustic signal also sounds.

The distance indication in the Driver Information Centre can be inhibited by vehicle messages with a higher priority. After approving the message by pressing **SET/CLR** on the turn signal lever, distance indication appears again.

Deactivation

The rear parking assist automatically switches off when reverse gear is disengaged.

The front parking assist is deactivated automatically at a speed above 11 km/h.



Manual deactivation is possible by pressing the parking assist button **P** or **P** briefly.

When the system is deactivated, the LED in the button extinguishes.

Additionally, **Park Assist Off** pops-up in the Driver Information Centre when the system is deactivated manually.

After a manual deactivation, the front parking assist is activated again if the parking assist button **P** or **P** is pressed or if reverse gear is engaged.

Fault

In the event of a fault in the system or if the system does not work due to temporary conditions, e.g. ice covered sensors, a message is displayed in the Driver Information Centre.

Vehicle messages ↗ 103.

Advanced parking assist

Warning

The driver bears full responsibility for accepting the parking slot suggested by the system and the parking manoeuvre.

Always check the surrounding area in all directions when using advanced parking assist.

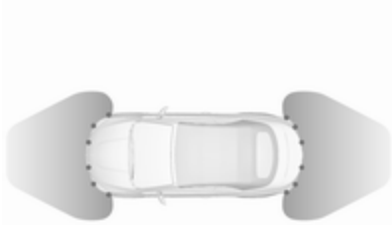



The advanced parking assist system manoeuvres the driver into a parking slot by giving instructions in the Driver Information Centre and via acoustic signals. The driver must control acceleration, braking, steering and gearshifting.

The system uses the sensors of the front-rear parking assist in combination with two additional sensors on both sides of the front and rear bumper.

Parking assist button and operation logic

Advanced parking assist and front-rear parking assist, (see previous description) are both operated by pressing .

Short press of  deactivates or activates the front parking assist.

Long press of  (approx. one second) activates or deactivates the advanced parking assist.

Button logic to operate the systems is as follows:

- Front-rear parking assist is active: short press deactivates front-rear parking assist.
- Front-rear parking assist is active: long press activates advanced parking assist if a forward gear is engaged.
- Advanced parking assist is active: short press activates front-rear parking assist.

- Advanced parking assist is active: long press deactivates advanced parking assist.
- Advanced parking assist and front-rear parking assist are active: short press deactivates both systems.

Activation



When searching for a parking slot, the system is ready to operate by pressing  for approx. one second.

The system can only be activated and can only search for a parking slot at a speed up to 30 km/h.

The maximum allowed parallel distance between the vehicle and a row of parked cars is 1.8 metres.

Functionality



When the vehicle passes a row of cars and the system is activated, the advanced parking assist system begins searching for a suitable parking slot. When a suitable slot is detected, visual feedback in the Driver Information Centre and an acoustic signal are given.

If the driver does not stop the vehicle within 10 metres after a parking slot is proposed, the system starts to search for another suitable parking slot.



The parking slot suggestion of the system is accepted when the vehicle is stopped by the driver within 10 metres after the "Stop" message is given. The system calculates the optimal route into the parking slot. Then it manoeuvres the driver into the slot by giving detailed instructions.

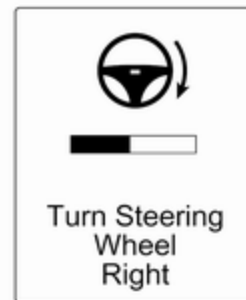

The instructions in the display show:

- A hint when driving faster than 30 km/h.
- The demand to stop the vehicle, when a parking slot is detected.
- The direction of driving during the parking manoeuvre.
- The steering wheel position during parking.
- For some of the instructions a progress bar is shown.



A successful parking manoeuvre is indicated by the 'End position' symbol.

Always pay attention to the sound of the front-rear parking assist. Continuous sound means that the distance to an obstacle is less than approx. 30 cm.

Changing the parking side

The system is configured to detect parking slots by default on the passenger side. To detect parking slots on the driver side, switch on turn indicator to the driver side for the duration of searching.



As soon as turn indicator is switched off, the system searches for parking slots on the passenger side again.

Display priorities

After activating the advanced parking assist, a message appears in the Driver Information Centre. Advanced parking assist indication in the Driver Information Centre can be inhibited by vehicle messages with a higher priority. After approving the message by pressing **SET/CLR** on the turn signal lever, advanced parking assist instructions appear again and the parking manoeuvre can be continued.

Deactivation

The system is deactivated by:

- short press of  if advanced parking assist and front-rear parking assist are activated
- long press of  if advanced parking assist is activated
- successfully ending parking manoeuvre
- driving faster than 30 km/h
- switching off the ignition

Deactivation by the driver or by the system during manoeuvring will be indicated by **Parking Deactivated** in the Driver Information Centre.

Fault

A message appears in the Driver Information Centre when:

- there is a fault in the system
- the driver did not successfully complete the parking manoeuvre
- the system is not operational

If an object is detected during parking instructions, **Stop** is indicated in the Driver Information Centre. Removing the object will resume the parking manoeuvre. If the object is not removed, the system will be deactivated. Press  for approx. one second to activate the system and search for a new parking slot.

Basic notes on parking assist systems

⚠ Warning

Under certain circumstances, various reflective surfaces on objects or clothing as well as external noise sources may cause the system to fail to detect obstacles.

Special attention must be paid to low obstacles which can damage the lower part of the bumper.

Caution

Performance of the system can be reduced when sensors are covered, e.g. by ice or snow.

Performance of the parking assist system can be reduced due to heavy loading.

Special conditions apply if there are taller vehicles in the vicinity (e.g. off-road vehicles, mini vans, vans). Object identification and

correct distance indication in the upper part of these vehicles cannot be guaranteed.

Objects with a very small reflection cross-section, e.g. objects of narrow size or soft materials, may not be detected by the system.

Parking assist systems do not detect objects outside the detection range.

Note

The parking assist system can be activated and deactivated by changing the settings in the Info-Display. If a trailer coupling is attached, it must be selected in the menu.

Vehicle personalisation ⇨ 104.

Note

The parking assist system automatically detects factory-fitted towing equipment. It is deactivated when the connector is plugged in.

It is possible that the sensor detects a non-existing object (echo disturbance) caused by external acoustical or mechanic disturbances.

Advanced parking assist system may not respond to changes in the parking space after initiating a parallel parking manoeuvre.

Note

After use the advanced parking assist requires a calibration. For optimal parking guidance, a driving distance of at least 35 km, including a number of bends, is required.

Side blind spot alert

The Side blind spot alert system detects and reports objects on either side of the vehicle, within a specified "blind spot" zone. The system displays a visual alert in each exterior mirror, when detecting objects that may not be visible in the interior and exterior mirrors.



The system's sensors are located in the bumper on the left and right side of the vehicle.

⚠ Warning

Side blind spot alert does not replace driver vision.

The system does not detect:



- vehicles outside the side blind zones which may be rapidly approaching
 - pedestrians, cyclists or animals
- Before changing a lane, always check all mirrors, look over the shoulder and use the turn signal.

When the system detects a vehicle in the side blind zone while driving forward, either while passing a vehicle or being passed, an amber warning symbol  will illuminate in the relevant exterior mirror. If the driver then activates the turn signal, the warning symbol  starts flashing amber as a warning not to change lanes.

Note

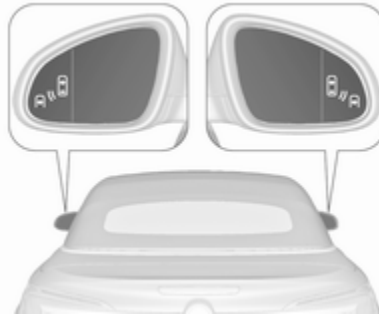
If the overtaking vehicle is at least 10 km/h faster than the vehicle being overtaken, the warning symbol  in the relevant exterior mirror may not illuminate.



Side blind spot alert is active from speeds of 10 km/h up to 140 km/h. Driving faster than 140 km/h deactivates the system, indicated by low lighting warning symbols  in both exterior mirrors. Reducing the speed again will extinguish the warning symbols. If a vehicle is then detected in the blind zone, the warning symbol  will illuminate as normal on the relevant side.

When the vehicle is started, both exterior mirror displays will briefly come on to indicate that the system is operating.

The system can be activated or deactivated in the menu **Settings** in the Info-Display. Vehicle personalisation  104.

Deactivation is indicated by a message in the Driver Information Centre.

Detection zones

The system sensor covers a zone of approx. 3 metres on both sides of the vehicle. This zone starts at each exterior mirror and extends rearwards by approx. 3 metres. The height of the zone is between approx. 0.5 metres and 2 metres off the ground.

The system is deactivated if the vehicle is towing a trailer.

Side blind spot alert is designed to ignore stationary objects such as guardrails, posts, curbs, walls and beams. Parked vehicles or oncoming vehicles are not detected.

Fault

Occasional missed alerts can occur under normal circumstances.

Side blind spot alert does not operate when the left or right corners of the rear bumper are covered with mud, dirt, snow, ice or slush. Cleaning instructions ⇨ 232.

In the event of a fault in the system or if the system does not work due to temporary conditions, a message is displayed in the Driver Information Centre. Seek the assistance of a workshop in case of a permanent fault.

Rear view camera

The rear view camera assists the driver when reversing by displaying a view of the area behind the vehicle.

The view of the camera is displayed in the Colour-Info-Display.

⚠ Warning

The rear view camera does not replace driver vision. Note that objects that are outside the camera's field of view and the advanced parking assist sensors, e.g. below the bumper or underneath the vehicle, are not displayed.

Do not reverse the vehicle by only looking at the Info-Display and check the surrounding area behind and around the vehicle before reversing.

Activation

Rear view camera is automatically activated when reverse gear is engaged.

Functionality



The camera is mounted between the number plate lights and has a viewing angle of 130°.

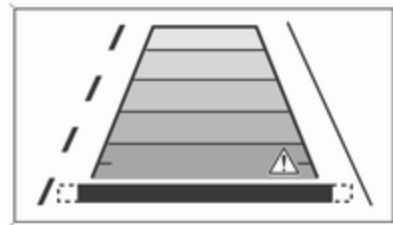

The area displayed by the camera is limited. The distance of the image that appears on the display differs from the actual distance.

Guiding lines

Dynamic guiding lines are horizontal lines in 1 metre intervals projected on the picture to define the distance to shown objects.

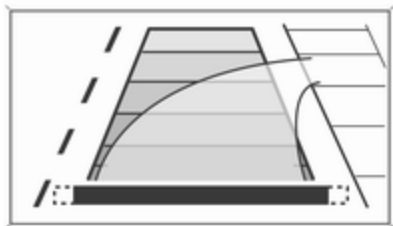

Trajectory lane of the vehicle is shown in accordance with the steering angle.

The function can be deactivated in the Settings menu in the Info-Display. Vehicle personalisation ↗ 104.

Warning symbols

Warning symbols are indicated as triangles \triangle on the picture, which show obstacles detected by the rear sensors of the advanced parking assist.

Additionally \triangle appears on the top line of the Info-Display with a warning to check the vehicle surrounding.

The top line of the display can be cleared by pressing the multifunction knob.

Display settings

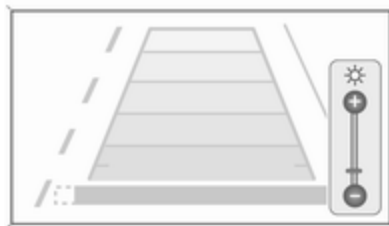

Navi 650/Navi 950: Brightness can be set by first pressing and then turning the outer ring of the multifunction knob.

CD 600: Brightness can be set by first pressing and then turning the multifunction knob.

Deactivation

The camera is deactivated when a certain forward speed is exceeded or if reverse gear is not engaged for approx. 10 seconds.

Activation or deactivation of the rear view camera can be changed in the Settings menu in the Info-Display. Vehicle personalisation ↗ 104.

Fault

Fault messages are displayed with a \triangle on the top line of the Info-Display.

The rear view camera may not operate properly when:

- The surrounding area is dark.
- The sun or the beam of headlights is shining directly into the camera lens.

- Ice, snow, mud, or anything else covers the camera lens. Clean the lens, rinse it with water, and wipe it with a soft cloth.
- The vehicle had a rear-end accident.
- There are extreme temperature changes.

Traffic sign assistant

Functionality

The traffic sign assistant system detects designated traffic signs via a front camera and displays them in the Driver Information Centre.



Traffic signs which will be detected are:

Limit and no passing signs

- speed limit
- no passing
- end of speed limit
- end of no passing

Road signs

Beginning and end of:

- motorways
- A-roads
- play streets

Add-on signs

- additional hints to traffic signs
- restriction of trailer towing
- tractor constraints
- wet warning
- ice warning
- direction arrows

Speed limit signs and no passing signs are displayed in the Driver Information Centre until the next speed limit sign or end of speed limit is detected or up to a defined sign timeout.

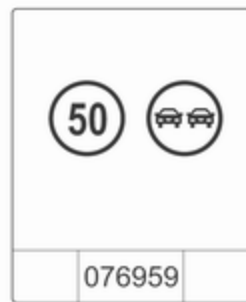

Indication of multiple signs on the display is possible.



An exclamation mark in a frame indicates that there is an add on sign detected which cannot be recognised by the system.

The system is active up to a speed of 200 km/h depending on the lighting conditions. At night the system is active up to a speed of 160 km/h.

As soon as vehicle speed becomes slower than 55 km/h the display will be reset and the content of the traffic sign page will be cleared, e.g. when entering a city zone. The next recognized speed indication will be displayed.

Display indication

Traffic signs are displayed in the **Traffic sign detection** page in the Driver Information Centre.



Select **Settings**  by pressing **MENU** and select **Traffic sign detection** entry via the adjuster wheel on the turn signal lever  96.

When another function in the Driver Information Centre menu was selected then **Traffic sign detection** page is chosen again, the last recognized traffic sign will be displayed.

Alert function

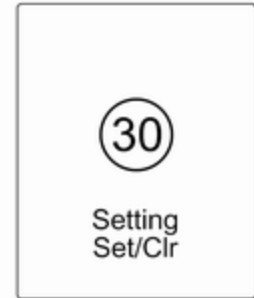

Once activated, speed limit and no passing signs are displayed as pop-up alerts in the Driver Information Centre.



The alert function can be activated or deactivated in the setting menu of the traffic sign assistant page by pressing **SET/CLR** on the turn signal lever.

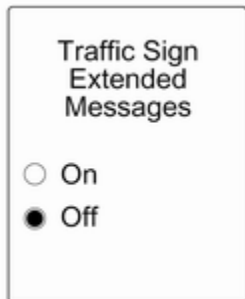

When the setting page is displayed, select **Off** to deactivate alert function. Reactivate by selecting **On**.

When switching on the ignition, alert function is deactivated.

Pop-up indication is displayed for approx. 8 seconds in the Driver Information Centre.

System reset

The content of the traffic sign memory can be cleared in the setting menu of the traffic sign assistant page by pressing and holding **SET/CLR** on the turn signal lever. Upon successful reset, a chime will sound and the following symbol is indicated until the next traffic sign is detected.



In some cases, traffic sign assistant is reset automatically by the system.

Fault

The traffic sign assistant system may not operate correctly when:

- The area of the windscreen, where the front camera is located, is not clean.
- Traffic signs are completely or partially covered or difficult to discern.
- There are adverse environmental conditions, e.g. heavy rain, snow, direct sunlight or shadows. In this

event, **No Traffic Sign Detection due to Weather** is indicated in the Driver Information Centre.

- Traffic signs are incorrectly mounted or damaged.
- Traffic signs do not comply with the Vienna Convention on Road Signs and Signals.

Caution

The system is intended to help the driver within a defined speed range to discern certain traffic signs. Do not ignore traffic signs which are not displayed by the system.

The system does not discern any other than the conventional traffic signs that might give or end a speed limit.

Do not let this special feature tempt you into taking risks when driving.

Always adapt speed to the road conditions.

The driver assistance systems do not relieve the driver from full responsibility for vehicle operation.

Lane departure warning

The lane departure warning system observes the lane markings between which the vehicle is driving via a front camera. The system detects lane changes and warns the driver in the event of an unintended lane change via visual and acoustic signals.



Criteria for the detection of an unintended lane change are:

- no operation of turn signals
- no brake pedal operation
- no active accelerator operation or speeding-up
- no active steering

If the driver is performing these actions, no warning will be issued.

Activation



The lane departure warning system is activated by pressing . The illuminated LED in the button indicates that the system is switched on. When the control indicator  in the instrument cluster illuminates green, the system is ready to operate.

The system is only operable at vehicle speeds above 56 km/h and if lane markings are available.

When the system recognises an unintended lane change, the control indicator  changes to yellow and flashes. Simultaneously a chime sound is activated.



Deactivation

The system is deactivated by pressing , the LED in the button extinguishes.

At speeds below 56 km/h the system is inoperable.

Fault

The lane departure warning system may not operate properly when:

- the windscreen is not clean
- there are adverse environmental conditions like heavy rain, snow, direct sunlight or shadows

The system cannot operate when no lane marking is detected.

Fuel

Fuel for petrol engines



Only use unleaded fuel that complies with European standard EN 228 or equivalent.

The engine is capable of running with fuel that contains up to 10% ethanol (e.g. named E10).

Use fuel with the recommended octane rating. A lower octane rating can reduce engine power and torque and slightly increases fuel consumption.

Caution

Do not use fuel or fuel additives that contain metallic compounds such as manganese-based additives. This may cause engine damage.

Caution

Use of fuel that does not comply to EN 228 or equivalent can lead to deposits or engine damage.

Caution

Use of fuel with a lower octane rating than the lowest possible rating could lead to uncontrolled combustion and engine damage.

The engine specific requirements regarding octane rating are given in the engine data overview ↗ 244. A country-specific label at the fuel filler flap can supersede the requirement.

Fuel additives outside Europe

Fuel should contain detergent additives that help prevent engine and fuel system deposits from forming. Clean fuel injectors and intake valves will allow the emission control system to work properly. Some fuel does not contain sufficient quantities of additive to keep fuel injectors and intake valves clean.

To make up for this lack of detergency, add Fuel System Treatment PLUS to the fuel tank at every engine oil change or every 15,000 km, whichever occurs first. It is available at your workshop.

Fuels containing oxygenates such as ethers and ethanol, as well as reformulated fuel, are available in some cities. If these fuels comply with the previously described specification, then they are acceptable to use. However, E85 (85% ethanol) and other fuels containing more than 15% ethanol must be used only in FlexFuel vehicles.

Caution

Do not use fuel containing methanol. It can corrode metal parts in the fuel system and also damage plastic and rubber parts. This damage would not be covered by the vehicle warranty.

Some fuels, mainly high octane racing fuels, can contain an octane enhancing additive called methylcyclopentadienyl manganese tricarbonyl (MMT). Do not use fuels or fuel additives with MMT as they can reduce spark plug life and affect emission control system performance. The malfunction indicator light  may illuminate ↗ 92. If this occurs, seek the assistance of a workshop.

Fuel for diesel engines



Only use diesel fuel that complies with EN 590 and which has a sulphur concentration of max. 10 ppm.

Fuels with a biodiesel (compliant with EN 14214) content of max. 7% by volume may be used (e.g. named B7).

If travelling in countries outside the European Union, occasional use of Euro-Diesel fuel with a sulphur concentration below 50 ppm is possible.

Caution

Frequent usage of diesel fuel containing more than 15 ppm sulphur will cause severe engine damage.

Caution

Use of fuel that does not comply to EN 590 or similar can lead to engine powerloss, increased wear or engine damage and may affect your warranty.

Do not use marine diesel oils, heating oils, Aquazole and similar diesel-water emulsions. Diesel fuels must not be diluted with fuels for petrol engines.

Low temperature operation

At temperatures below 0° C, some diesel products with biodiesel blends may clog, freeze or gel, which may affect the fuel supply system. Starting and engine operation may not work properly. Make sure to fill winter grade diesel fuel at ambient temperatures below 0°C.

Arctic grade diesel fuel can be used in extreme cold temperatures below -20° C. Using this fuel grade in warm or hot climates is not recommended

and may cause engine stalling, poor starting or damage on the fuel injection system.

Refuelling

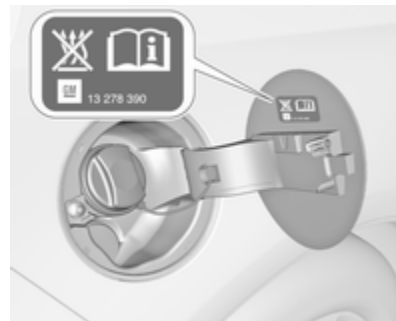

⚠ Danger

Before refuelling, switch off ignition and any external heaters with combustion chambers. Switch off any mobile phones.

Follow the operating and safety instructions of the filling station when refuelling.

⚠ Danger

Fuel is flammable and explosive. No smoking. No naked flames or sparks.

If you can smell fuel in your vehicle, have the cause of this remedied immediately by a workshop.

A label with symbols at the fuel filler flap is indicating the allowed fuel types. In Europe the pump nozzles of the filling stations are marked with these symbols. Refuel only the allowed fuel type.

Caution

In case of misfuelling, do not switch on ignition.

Fuel filler flap is located at right rear side of vehicle.



The fuel filler flap can only be opened if the vehicle is unlocked. Release the fuel filler flap by pushing the flap.

To open, turn the cap slowly anticlockwise.



The fuel filler cap can be retained in the bracket on the fuel filler flap.

To refuel, fully insert the pump nozzle and switch it on.

After the automatic cut-off, the tank can be topped up by operating the pump nozzle a maximum of two more times.

Caution

Wipe off any overflowing fuel immediately.

To close, turn the fuel filler cap clockwise until it clicks.

Close the flap and allow it to engage.

Vehicles with misfuel inhibitor**⚠ Warning**

Do not try to open the flap of the fuel filler neck manually on vehicles with misfuel inhibitor.

Disregard could lead to trapping of the fingers.

Vehicles with a selective catalytic reduction system are equipped with a misfuel inhibitor.

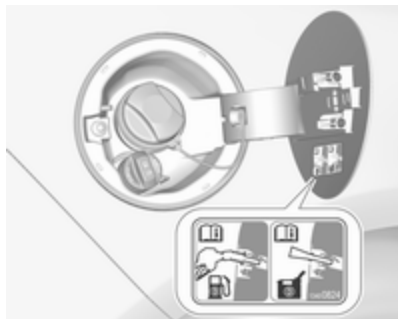

The misfuel inhibitor ensures that the flap of the fuel filler neck can only be opened by using a nozzle for diesel fuel or a funnel for emergency refilling.

Turn the fuel filler cap slowly anticlockwise.

The cap can be retained in the bracket on the fuel filler flap.

Place the nozzle in a straight line to the filler neck and press with slight force to insert.

In case of an emergency, refill with a canister. A funnel must be used to open the cap of the filler neck.

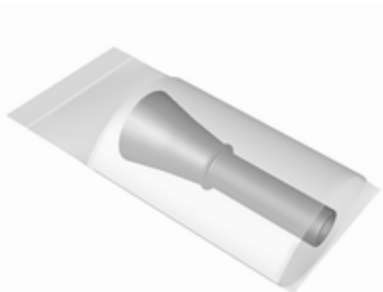

The funnel is located in the load compartment.

Place the funnel in a straight line to the filler neck and press with slight force to insert.

Use the funnel to fill the diesel fuel into the filler neck.

After topping-up, put the funnel into the plastic bag and stow it in the storage compartment.

Selective catalytic reduction system
⇨ 145.

Fuel filler cap

Only use genuine fuel filler caps. Diesel-engined vehicles have special fuel filler caps.

Trailer hitch

General information

Only use towing equipment that has been approved for your vehicle. Entrust retrofitting of towing equipment to a workshop. It may be necessary to make changes that affect the cooling system, heat shields or other equipment.

The bulb outage detection function for trailer brake light cannot detect a partial bulb outage, e.g. in case of 4 x 5 Watt bulbs, the function only detects lamp outage when only a single 5 Watt lamp remains or none remain.

Fitting of towing equipment could cover the opening of the towing eye. If this is the case use the coupling ball bar for towing. Always keep the coupling ball bar in the vehicle.

Driving characteristics and towing tips

Before attaching a trailer, lubricate the coupling ball. However, do not do so if a stabiliser, which acts on the coupling ball, is being used to reduce snaking movements.

For trailers with low driving stability and caravan trailers with a permitted gross vehicle weight of more than 1200 kg the use of a stabiliser is strongly recommended when driving above 80 km/h.

If the trailer starts snaking, drive more slowly, do not attempt to correct the steering and brake sharply if necessary.

When driving downhill, drive in the same gear as if driving uphill and drive at a similar speed.

Adjust tyre pressure to the value specified for full load ↗ 248.

Trailer towing

Trailer loads

The permissible trailer loads are vehicle and engine-dependent maximum values which must not be exceeded. The actual trailer load is the difference between the actual gross weight of the trailer and the actual coupling socket load with the trailer coupled.

The permissible trailer loads are specified in the vehicle documents. In general, they are valid for gradients up to max. 12%.

The permitted trailer load applies up to the specified incline and up to an altitude of 1000 metres above sea level. Since engine power decreases as altitude increases due to the air becoming thinner, therefore reducing climbing ability, the permissible gross train weight also decreases by 10% for every 1000 metres of additional altitude. The gross train weight does not have to be reduced when driving on roads with slight inclines (less than 8%, e.g. motorways).

The permissible gross train weight must not be exceeded. This weight is specified on the identification plate ↪ 239.

Vertical coupling load

The vertical coupling load is the load exerted by the trailer on the coupling ball. It can be varied by changing the weight distribution when loading the trailer.

The maximum permissible vertical coupling load (75 kg) is specified on the towing equipment identification plate and in the vehicle documents. Always aim for the maximum load, especially in the case of heavy trailers. The vertical coupling load should never fall below 25 kg.

Rear axle load

When the trailer is coupled and the towing vehicle fully loaded, the permissible rear axle load (see identification plate or vehicle documents) may be exceeded by 100 kg, the gross vehicle weight rating may be exceeded by 100 kg. If the permissible rear axle load is exceeded, a maximum speed of 100 km/h applies.

Towing equipment

Caution
When operating without a trailer, remove the coupling ball bar.

Stowage of coupling ball bar

The coupling ball bar is stowed in a bag and must be secured in the load compartment.

Vehicle with spare wheel



The bag with the coupling ball bar is placed near the spare wheel under the load floor cover.

Direct the strap through the rim and around the wheel, wrap it around the coupling ball bar and tighten the strap to secure the bag.

Vehicles with tyre repair kit



The bag with the coupling ball bar is placed near the tyre repair kit box under the load floor cover.

The strap is directed around the threaded bolt under the tyre repair kit box. Wrap the strap around the coupling ball bar and tighten the strap to secure the bag.

Vehicles with flat load compartment floor

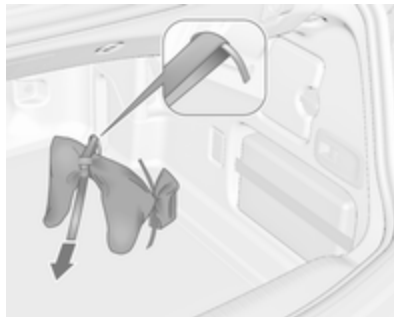

The bag with the coupling ball bar is stowed on the right side of the load compartment floor.

Direct the strap through the rear right lashing eye, wrap it twice around the coupling ball bar and tighten the strap to secure the bag.

Fitting the coupling ball bar

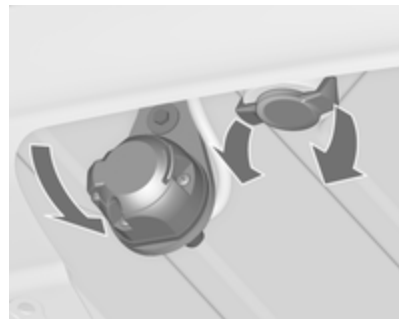

Disengage and fold down the socket. Remove the sealing plug from the opening for the coupling ball bar and stow it.

Checking the tensioning of the coupling ball bar



- Red marking on rotary knob must point towards green marking on coupling ball bar.
- The gap between the rotary knob and the coupling ball bar must be approx. 6 mm.
- The key must be in position .

Otherwise, the coupling ball bar must be tensioned before being inserted:

- Unlock coupling ball bar by turning key to position .

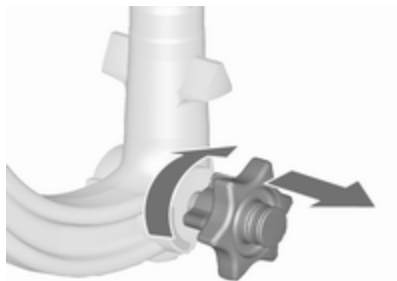

- Pull out rotary knob and turn clockwise as far as it will go.

Inserting the coupling ball bar

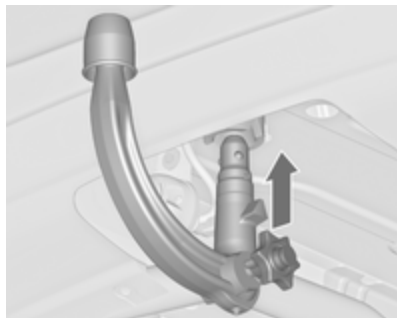

Insert the tensioned coupling ball bar in the opening and push firmly upwards until it audibly engages.

The rotary handle snaps back into its original position resting against the coupling ball bar without a gap.

Warning

Do not touch rotary handle during insertion.

Lock the coupling ball bar by turning the key to position . Remove the key and close the protective flap.

Eye for break-away stopping cable

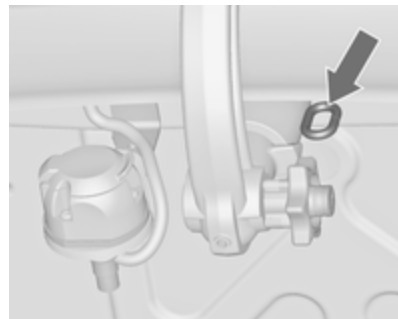

Attach breakaway stopping cable to eye.

Check that the coupling ball bar is correctly installed

- Green marking on rotary knob must point towards green marking on coupling ball bar.
- There must be no gap between the rotary handle and the coupling ball bar.
- The coupling ball bar must be firmly engaged in the opening.
- The coupling ball bar must be locked and the key removed.

⚠ Warning

Towing a trailer is permitted only when a coupling ball bar is fitted correctly. If the coupling ball bar does not engage correctly, seek the assistance of a workshop.

Dismounting the coupling ball bar

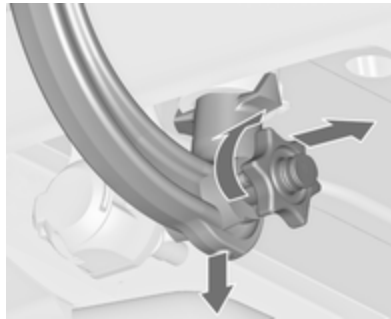

Open the protective flap and turn the key to position  to unlock the coupling ball bar.

Pull out rotary handle and turn clockwise as far as it will go. Pull out coupling ball bar downwards.

Insert sealing plug in opening. Fold away socket.

Stow and secure the coupling ball bar as mentioned above.

Vehicle care

General Information 191

- Accessories and vehicle modifications 191
- Vehicle storage 191
- End-of-life vehicle recovery 192

Vehicle checks 192

- Performing work 192
- Bonnet 192
- Engine oil 193
- Engine coolant 194
- Washer fluid 195
- Brakes 195
- Brake fluid 196
- Vehicle battery 196
- Diesel fuel system bleeding 197
- Wiper blade replacement 198

Bulb replacement 198

- Halogen headlights 198
- Adaptive forward lighting 200
- Fog lights 201
- Front turn lights 202
- Tail lights 203
- Side turn lights 204
- Number plate light 205

- Interior lights 206
- Instrument panel illumination ... 206

Electrical system 206

- Fuses 206
- Engine compartment fuse box . 207
- Instrument panel fuse box 209
- Load compartment fuse box ... 210

Vehicle tools 212

- Tools 212

Wheels and tyres 213

- Winter tyres 213
- Tyre designations 213
- Tyre pressure monitoring system 213
- Tyre pressure 217
- Tread depth 218
- Changing tyre and wheel size . 218
- Wheel covers 219
- Tyre chains 219
- Tyre repair kit 219
- Wheel changing 222
- Spare wheel 225

Jump starting 228

Towing 230

- Towing the vehicle 230
- Towing another vehicle 231

Appearance care 232

- Exterior care 232
- Interior care 234

General Information

Accessories and vehicle modifications

We recommend the use of genuine parts and accessories and factory approved parts specific for your vehicle type. We cannot assess or guarantee reliability of other products - even if they have a regulatory or otherwise granted approval.

Any modification, conversion or other changes made to standard vehicle specifications (including, without limitation, software modifications, modifications of the electronic control units) may invalidate the warranty offered by Opel. Furthermore, such changes may affect driver assistance systems, may impact fuel consumption, CO₂ emissions and other emissions of the vehicle and cause the vehicle to no longer conform to the operating permit, impacting the validity of your vehicle registration.

Caution

When transporting the vehicle on a train or on a recovery vehicle, the mud flaps may be damaged.

Vehicle storage

Storage for a long period of time

If the vehicle is to be stored for several months:

- Wash the vehicle. Wax painted parts of the vehicle. Exterior care ⇨ 232.
- Have the wax in the engine compartment and underbody checked.
- Clean and preserve the rubber seals.
- Fill up fuel tank completely.
- Change the engine oil.
- Drain the washer fluid reservoir.
- Check the coolant antifreeze and corrosion protection.
- Adjust tyre pressure to the value specified for full load.

- Park the vehicle in a dry, well ventilated place. Engage first or reverse gear or set selector lever to **P**. Prevent the vehicle from rolling.
- Do not apply the parking brake.
- Open the bonnet, close all doors and lock the vehicle.
- Close the soft top.
- Cover the soft top to reduce environmental influences.
- Disconnect the clamp from the negative terminal of the vehicle battery. Beware that all systems are not functional, e.g. anti-theft alarm system.

Putting back into operation

When the vehicle is to be put back into operation:

- Connect the clamp to the negative terminal of the vehicle battery. Activate the electronics of the power windows.
- Check tyre pressure.
- Fill up the washer fluid reservoir.
- Check the engine oil level.

- Check the coolant level.
- Since the durability of AdBlue is limited to two years, fluid should be exchanged if it is too old. Seek the assistance of a workshop.
- Fit the number plate if necessary.

End-of-life vehicle recovery

Information on end-of-life vehicle recovery centres and the recycling of end-of-life vehicles is available on our website, where legally required. Only entrust this work to an authorised recycling centre.

Vehicle checks

Performing work



Warning

Only perform engine compartment checks when the ignition is off.
The cooling fan may start operating even if the ignition is off.

Danger

The ignition system and Xenon headlights use extremely high voltage. Do not touch.

Bonnet

Opening



Pull the release lever and return it to its original position.



Move the safety catch sideways to the left vehicle side and open the bonnet.

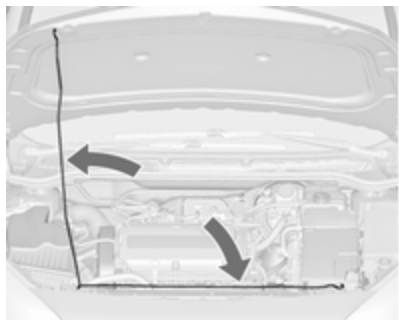

Secure the bonnet support.

If the bonnet is opened during an Autostop, the engine will be restarted automatically for safety reasons.

Closing

Before closing the bonnet, press the support into the holder.

Lower the bonnet and allow it to fall into the latch from a low height (20-25 cm). Check that the bonnet is engaged.

Caution

Do not press the bonnet into the latch, to avoid dents.

Engine oil

Check the engine oil level manually on a regular basis to prevent damage to the engine. Ensure that the correct specification of oil is used.

Recommended fluids and lubricants ⇨ 236.

The maximum engine oil consumption is 0.6 litres per 1000 km.

Check with the vehicle on a level surface. The engine must be at operating temperature and switched off for at least five minutes.

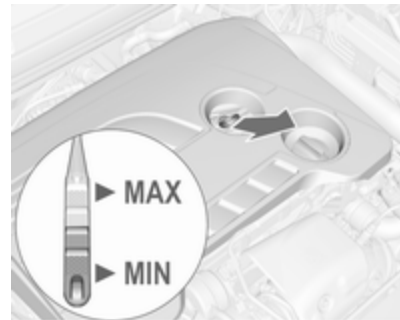

Pull out the dipstick, wipe it clean, reinsert it fully, pull out and read the engine oil level.

Different dipsticks are used depending on engine variant.

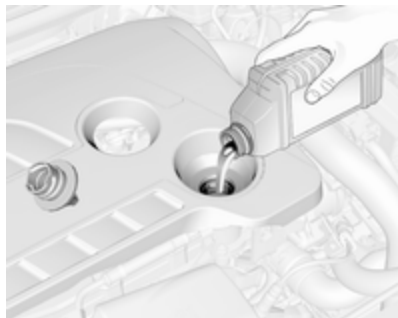

When the engine oil level has dropped to the **MIN** mark, top-up engine oil.

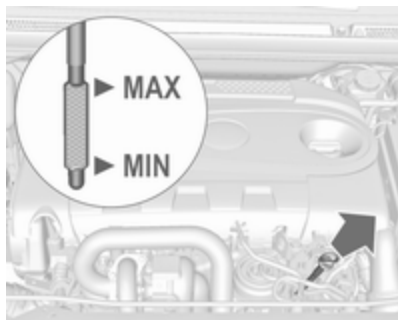

We recommend the use of the same grade of engine oil that was used at the last change.



The engine oil level must not exceed the **MAX** mark on the dipstick.

Caution

Overfilled engine oil must be drained or suctioned out.

Capacities ⇨ 247.

Fit the cap on straight and tighten it.

Engine coolant

The coolant provides freeze protection down to approx. -28°C . In cold regions with very low temperatures, the factory filled coolant provides frost protection down to approx. -37°C .

Caution

Only use approved antifreeze.

Coolant and antifreeze ⇨ 236.

Coolant level

Caution

Too low a coolant level can cause engine damage.

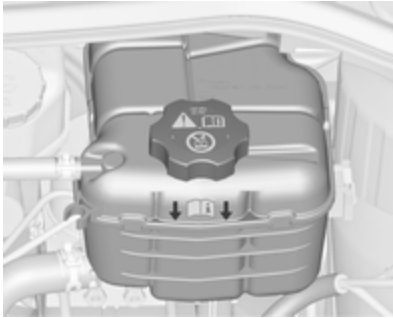

If the cooling system is cold, the coolant level should be above the filling line mark. Top up if the level is low.

Warning

Allow the engine to cool before opening the cap. Carefully open the cap, relieving the pressure slowly.

To top up use a 1:1 mixture of released coolant concentrate mixed with clean tap water. If no coolant concentrate is available, use clean tap water. Install the cap tightly. Have

the coolant concentration checked and have the cause of the coolant loss remedied by a workshop.

Washer fluid



Fill with clean water mixed with a suitable quantity of approved windscreen washer fluid which contains antifreeze.

Caution

Only washer fluid with a sufficient antifreeze concentration provides protection at low temperatures or after a sudden drop in temperature.

Use of washer fluid containing isopropanol can damage exterior lamps.

Washer fluid ⇨ 236.

Brakes

In the event of minimum thickness of the brake lining, a squealing noise sounds during braking.

Continued driving is possible but have the brake lining replaced as soon as possible.

Once new brake linings are installed, do not brake unnecessarily hard for the first few journeys.

Brake fluid

⚠ Warning

Brake fluid is poisonous and corrosive. Avoid contact with eyes, skin, fabrics and painted surfaces.

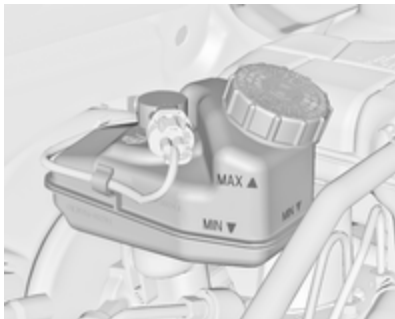

The brake fluid level must be between the **MIN** and **MAX** marks.

If fluid level is below **MIN** seek the assistance of a workshop.

Brake and clutch fluid ⇨ 236.

Vehicle battery

The vehicle battery is maintenance-free provided that the driving profile allows sufficient charging of the battery. Short-distance-driving and frequent engine starts can discharge the battery. Avoid the use of unnecessary electrical consumers.



Batteries do not belong in household waste. They must be disposed of at an appropriate recycling collection point.

Laying up the vehicle for more than four weeks can lead to battery discharge. Disconnect the clamp from the negative terminal of the vehicle battery.

Ensure the ignition is switched off before connecting or disconnecting the vehicle battery.

Battery discharge protection ⇨ 126.

Disconnecting the battery

If the vehicle's battery is to be disconnected (e.g. for maintenance work), the alarm siren must be deactivated as follows: Switch the ignition on then off, then disconnect the vehicle's battery within 15 seconds.

Replacing the vehicle battery

Note

Any deviation from the instructions given in this section may lead to temporary deactivation or disturbance of the stop-start system.

When the vehicle battery is being replaced, please ensure that there are no open ventilation holes in the vicinity of the positive terminal. If a ventilation hole is open in this area, it must be closed off with a dummy cap, and the ventilation in the vicinity of the negative terminal must be opened.

Only use vehicle batteries that allow the fuse box to be mounted above the vehicle battery.

Ensure that the battery is always replaced by the same type of battery.

We recommend that you have the vehicle battery replaced by a workshop.

Stop-start system ⇨ 140.

Charging the vehicle battery

⚠ Warning

On vehicles with stop-start system, ensure that the charging potential does not exceed 14.6 volts when using a battery charger. Otherwise the vehicle battery may be damaged.

Jump starting ⇨ 228.

Warning label



Meaning of symbols:

- No sparks, naked flames or smoking.
- Always shield eyes. Explosive gases can cause blindness or injury.
- Keep the vehicle battery out of reach of children.
- The vehicle battery contains sulphuric acid which could cause blindness or serious burn injuries.

- See the Owner's Manual for further information.
- Explosive gas may be present in the vicinity of the vehicle battery.

Diesel fuel system bleeding

If the tank has been run dry, the diesel fuel system must be bled. Switch on the ignition three times for 15 seconds at a time. Then crank the engine for a maximum of 40 seconds. Repeat this process after no less than 5 seconds. If the engine fails to start, seek the assistance of a workshop.

Wiper blade replacement

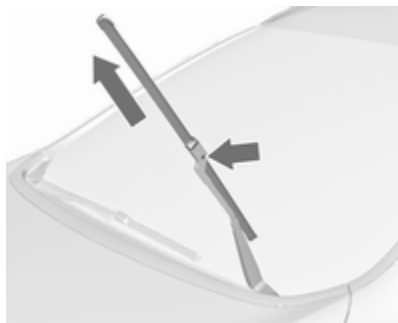

Lift the wiper arm until it stays in the raised position, press button to disengage the wiper blade and remove.

Attach the wiper blade slightly angled to the wiper arm and push until it engages.

Lower wiper arm carefully.

Bulb replacement

Switch off the ignition and switch off the relevant switch or close the doors.

Only hold a new bulb at the base. Do not touch the bulb glass with bare hands.

Use only the same bulb type for replacement.

Replace headlight bulbs from within the engine compartment.

Bulb check

After a bulb replacement switch on the ignition, operate and check the lights.

Halogen headlights

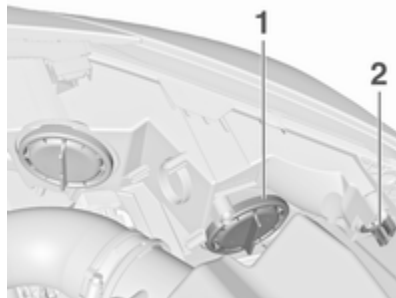

Bi-Halogen Headlight (1) with one bulb for low and high beam.
Sidelight/Daytime running light (2).

Low/High beam (1)

1. Rotate the cap (1) anticlockwise and remove it.

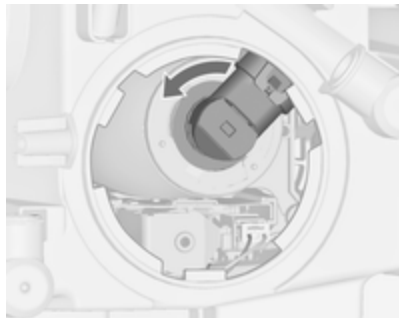

2. Rotate the bulb holder anticlockwise to disengage. Withdraw the bulb holder from the reflector.

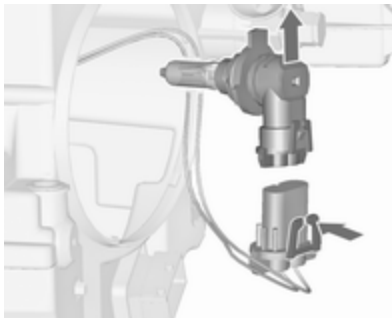

3. Disengage the bulb holder from the plug connector by pressing the retaining lug.
4. Replace the bulb and connect bulb holder with the plug connector.
5. Insert the bulb holder, engaging the two lugs into the reflector and rotate clockwise to secure.
6. Fit the cap and rotate clockwise.

Sidelight/Daytime running light (2)

1. Rotate bulb socket (2) anticlockwise to disengage. Withdraw the bulb socket from the reflector.

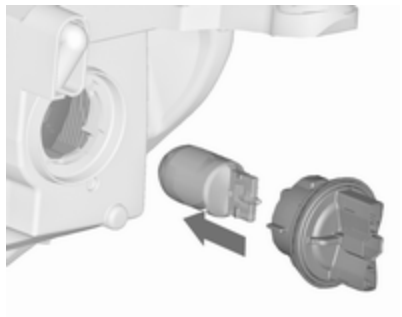

2. Remove the bulb from the socket by pulling.
3. Replace and insert new bulb into socket.
4. Insert the bulb socket into the reflector and turn clockwise.

Adaptive forward lighting

⚠ Danger

Adaptive forward lighting system uses Xenon headlights.

Xenon headlights work under extremely high electrical voltage. Do not touch. Have bulbs replaced by a workshop.

Bulbs for front turn signal and corner lighting can be changed.

Sidelight/Daytime running lights are designed as Light Emitting Diodes (LEDs) and cannot be changed.

Corner lighting

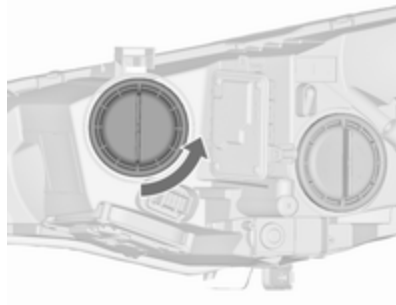

1. Rotate the cap anticlockwise and remove it.



2. Rotate the bulb holder anticlockwise to disengage. Withdraw the bulb holder from the reflector.

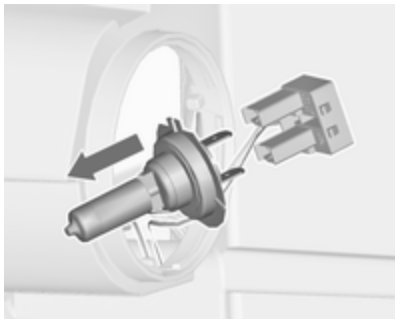

3. Disengage the bulb from the plug connector by pulling.
4. Replace the bulb and connect the bulb holder with the plug connector.
5. Insert the bulb holder, engaging the two lugs into the reflector and rotate clockwise to secure.
6. Fit the cap and rotate clockwise.

Fog lights

The bulbs are accessible from the underside of the vehicle.

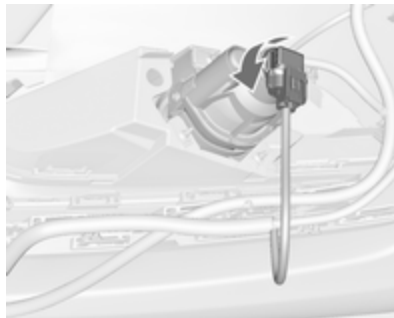

1. Turn the bulb holder anticlockwise and remove it from the reflector.

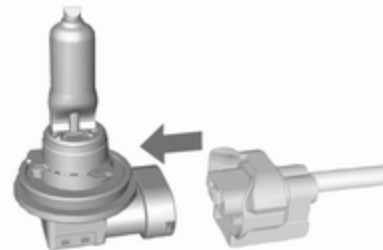

2. Disengage the bulb socket from the plug connector by pressing the retaining lug.
3. Remove and replace the bulb socket with bulb and attach the plug connector.
4. Insert the bulb socket into the reflector by turning clockwise and engage.

Front turn lights

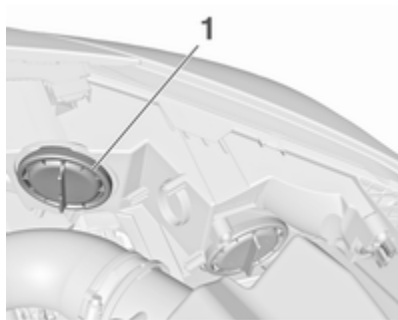

1. Rotate cap (1) anticlockwise and remove it.



2. The illustration shows version with halogen headlights.



The illustration shows version with adaptive forward lighting headlights.

Rotate bulb socket anticlockwise to disengage and withdraw from the reflector.

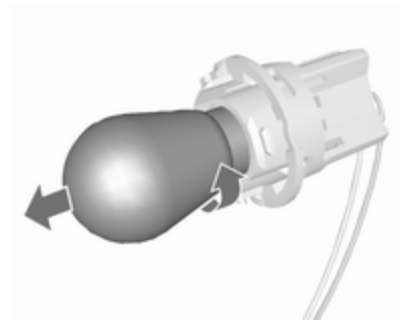

3. Remove the bulb from the socket by turning anticlockwise.
4. Replace and insert new bulb into socket by turning clockwise.
5. Insert the bulb socket into the reflector and turn clockwise.
6. Fit the cap and rotate clockwise.

Tail lights

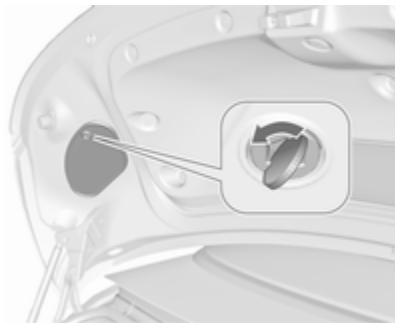

1. Open and remove the cover on the inside of the boot lid by loosening the screw with a coin.
2. Brake lights, tail lights and fog light are designed as Light Emitting Diodes (LEDs) and cannot be changed.



Remove bulb holder by turning anticlockwise.

Turn signal lights (1)
Reversing lights (2)

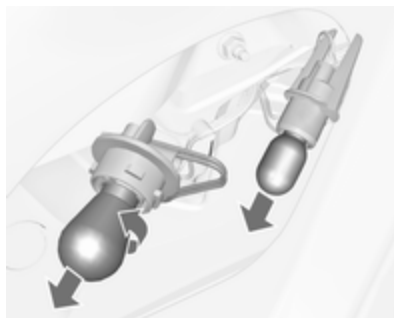

3. Remove and replace bulb

4. Insert bulb holder into tail light assembly and turn clockwise.

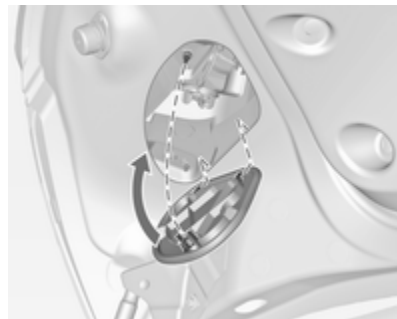

5. Close the cover by inserting the fastener clips first. Lock the cover by turning the screw clockwise with a coin.

Additional lights in the boot lid frame

1. Open the boot lid.



2. Release cover in side trim panel and remove.

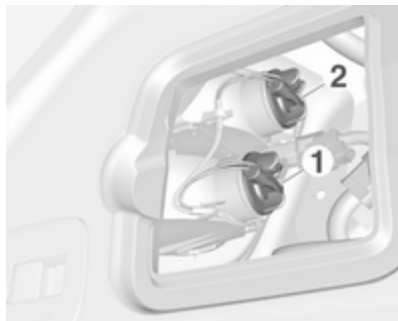

3. Remove bulb holder by turning anticlockwise.

- Turn signal lights (1)
- Tail lights (2)



4. Remove and replace bulb.
5. Insert the bulb holder into housing and turn clockwise.
6. Attach the side trim cover.

Side turn lights

To replace bulb, remove lamp housing:

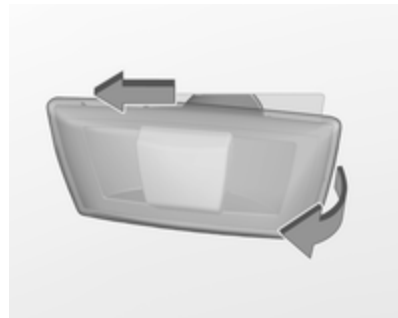

1. Slide lamp to its left side and remove with its right end.



2. Turn bulb holder anticlockwise and remove from housing.

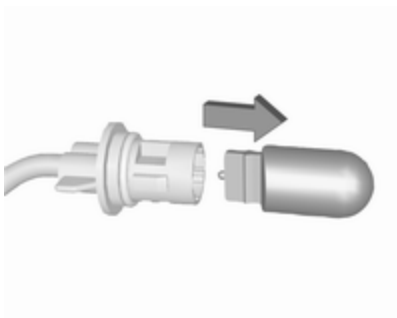

3. Pull bulb from bulb holder and replace it.

4. Insert bulb holder and turn clockwise.
5. Insert left end of the lamp, slide to the left and insert right end.

Number plate light



1. Insert screwdriver in recess of the cover, press to the side and release spring.
2. Remove lamp downwards, taking care not to pull on the cable.



3. Remove bulb holder from lamp housing by turning anticlockwise.

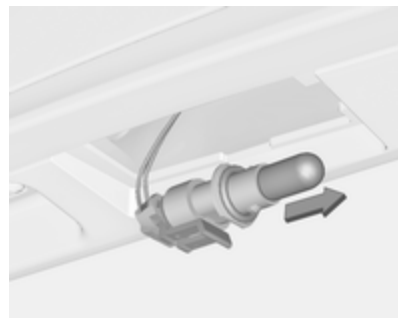

4. Pull bulb from bulb holder and replace it.

5. Insert bulb holder into lamp housing and turn clockwise.
6. Insert lamp into bumper and let engage.

Interior lights

Courtesy light, reading lights

Have bulbs replaced by a workshop.

Load compartment light

Have bulbs replaced by a workshop.

Instrument panel illumination

Have bulbs replaced by a workshop.

Electrical system

Fuses

Data on the replacement fuse must match the data on the defective fuse.

There are three fuse boxes in the vehicle:

- In the front left of the engine compartment,
- In left-hand drive vehicles, in the interior behind the storage compartment, or, in right-hand drive vehicles, behind the glovebox,
- Behind a cover on the left side of the load compartment.

Before replacing a fuse, turn off the respective switch and the ignition.

A blown fuse can be recognized by its melted wire. Do not replace the fuse until the cause of the fault has been remedied.

Some functions are protected by several fuses.

Fuses may also be inserted without existence of a function.

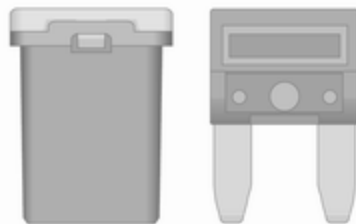

Fuse extractor

A fuse extractor may be located in the fuse box in the engine compartment.

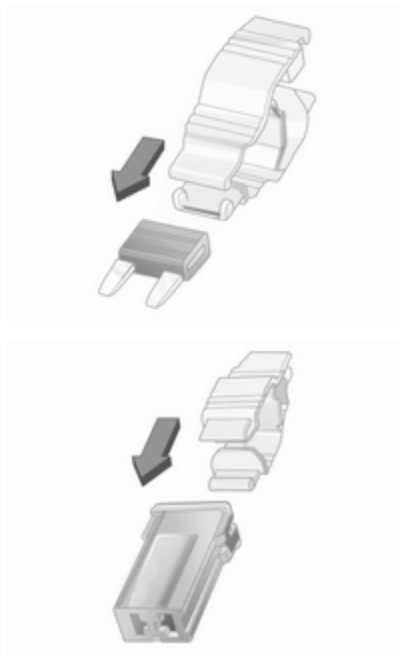

Place the fuse extractor on the various types of fuse from the top or side, and withdraw fuse.

Engine compartment fuse box

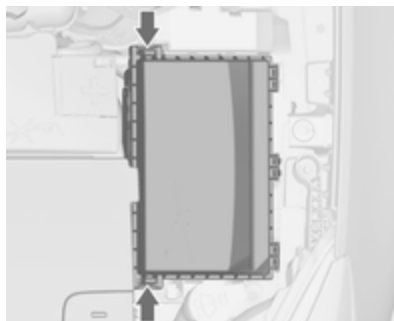

The fuse box is in the front left of the engine compartment. Disengage the cover and fold it upwards until it stops. Remove the cover vertically upwards.



No. Circuit

- 1 Engine control module
- 2 Lambda sensor
- 3 Fuel injection, ignition system
- 4 Fuel injection, ignition system
- 5 –
- 6 Mirror heating
- 7 Fan control
- 8 Lambda sensor, engine cooling
- 9 Rear window sensor
- 10 Vehicle battery sensor
- 11 Trunk release
- 12 Adaptive forward lighting, automatic light control
- 13 ABS Valves
- 14 –
- 15 Engine control module
- 16 Starter
- 17 Transmission control module

No. Circuit

- 18 Heated rear window
- 19 Front power windows
- 20 Rear power windows
- 21 Rear electrical centre
- 22 Left high beam (Halogen)
- 23 Headlamp washer system
- 24 Right low beam (Xenon)
- 25 Left low beam (Xenon)
- 26 Front fog lights
- 27 Diesel fuel heating
- 28 Start stop system
- 29 Electric parking brake
- 30 ABS pump
- 31 –
- 32 Airbag
- 33 Adaptive forward lighting, automatic light control
- 34 Exhaust gas recirculation

No. Circuit

- 35 Power windows, rain sensor, exterior mirror
- 36 Climate control
- 37 –
- 38 Vacuum pump
- 39 Fuel system control module
- 40 Windscreen washer system
- 41 Right high beam (Halogen)
- 42 Radiator fan
- 43 Windscreen wiper
- 44 –
- 45 Radiator fan
- 46 –
- 47 Horn
- 48 Radiator fan
- 49 Fuel pump
- 50 Headlamp levelling, adaptive forward lighting

No. Circuit

- 51 –
- 52 Auxiliary heater, diesel engine
- 53 Transmission control module, Engine control module
- 54 Vacuum pump, instrument panel cluster, heating ventilation, air conditioning system

After having changed defective fuses, close the fuse box cover and press until it engages.

If the fuse box cover is not closed correctly, malfunctions may occur.

Instrument panel fuse box

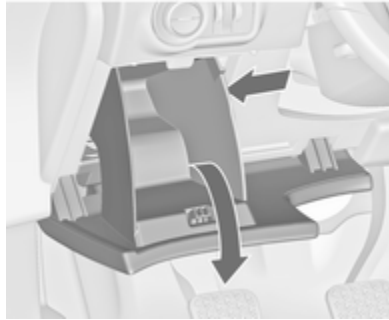

In left-hand drive vehicles, the fuse box is behind the storage compartment in the instrument panel. Open the compartment and push it to the left to unlock. Fold the compartment down and remove it.

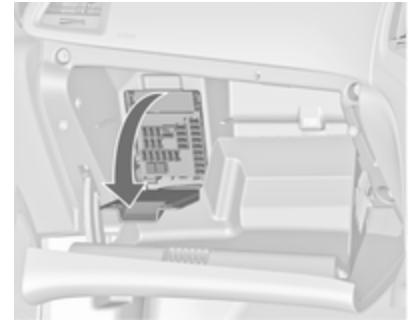

In right-hand drive vehicles, the fuse box is located behind a cover in the glovebox. Open the glovebox, then open the cover and fold it down.

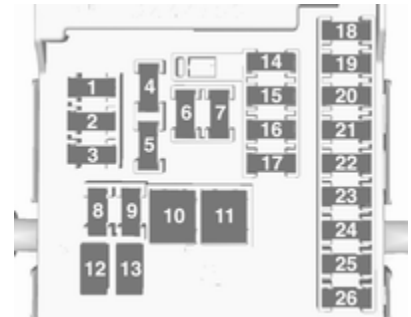

No. Circuit

- 1 Displays
- 2 Body control unit, exterior lights
- 3 Body control unit, exterior lights
- 4 Infotainment system
- 5 Infotainment system, instrument
- 6 Power outlet, cigarette lighter
- 7 Power outlet
- 8 Body control module, left low beam
- 9 Body control module, right low beam
- 10 Body control module, door locks
- 11 Interior fan
- 12 Driver power seat
- 13 Passenger power seat
- 14 Diagnostic connector
- 15 Airbag
- 16 Boot lid relay

No. Circuit

- 17 Air conditioning system
- 18 Service diagnose
- 19 Body control module, brake lights, tail lights, interior lights
- 20 -
- 21 Instrument panel
- 22 Ignition system
- 23 Body control module
- 24 Body control module
- 25 -
- 26 Trunk power outlet accessory

Load compartment fuse box

The fuse box is on the left side of the load compartment behind a cover.



Remove the cover.

Fuse assignments

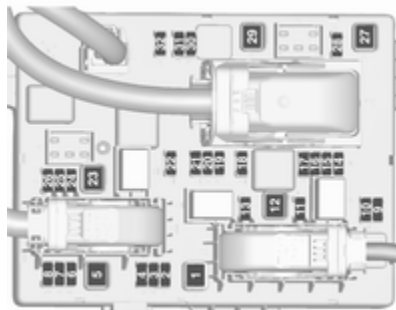

No. Circuit

- 1 Soft top control module, power rail right
- 2 –
- 3 Parking assist
- 4 Selective catalytic reduction system
- 5 –
- 6 –
- 7 Power seat
- 8 Soft top control module
- 9 Selective catalytic reduction system
- 10 Selective catalytic reduction system
- 11 Trailer module, tyre pressure monitor and rear view camera
- 12 Soft top control module, tail lights
- 13 –

No. Circuit

- 14 Rear seat electrical folding
- 15 –
- 16 Seat ventilation, rear view camera, soft top control module
- 17 –
- 18 –
- 19 Steering wheel heating
- 20 –
- 21 Seat heating
- 22 –
- 23 Soft top control module, power rail left
- 24 Selective catalytic reduction system
- 25 –
- 26 Jumper fuse for non logistic mode
- 27 Passive entry
- 28 –

No. Circuit

- 29 Hydraulic unit
- 30 –
- 31 –
- 32 Flex Ride

Vehicle tools

Tools

Vehicles with spare wheel



Open the load floor cover. The jack, the tools and a strap for securing a damaged wheel are in the tool box below the spare wheel in the load compartment.

The wheel wrench and the towing eye are in the tool bag located in the spare wheel well near the tool box. The tool bag is fixated with a tether to the stow

rod. Remove tool box and tool bag tether from the stow rod to access the tools in the bag.

Spare wheel ⇨ 225.

Vehicles without spare wheel



Some tools and the towing eye are located in a tool box in the load compartment below the floor cover.

Vehicles without spare wheel and flat load compartment floor

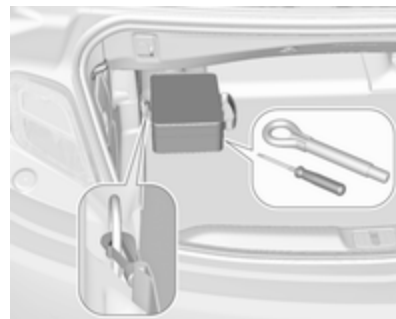

Some tools and the towing eye are located in a bag, which is fixed at the front left lashing eye in the load compartment.

Wheels and tyres

Wheels

On vehicles with Diesel engines, no steel rims and only special, vehicle-approved alloy wheels are permitted.

Tyre condition, wheel condition

Drive over edges slowly and at right angles if possible. Driving over sharp edges can cause tyre and wheel damage. Do not trap tyres on the kerb when parking.

Regularly check the wheels for damage. Seek the assistance of a workshop in the event of damage or unusual wear.

Winter tyres

Winter tyres improve driving safety at temperatures below 7 °C and should therefore be fitted on all wheels.

All tyre sizes are permitted as winter tyres ⇨ 248.

Use tyre size 245/45 R18 only as winter tyres.

On vehicles with Diesel engines, no steel rims and only special, vehicle-approved alloy wheels are permitted.

In accordance with country-specific regulations, affix the speed sticker in the driver's field of view.

Tyre designations

E.g. **235/55 R 17 99 V**

- 235** : Tyre width, mm
- 55** : Cross-section ratio (tyre height to tyre width), %
- R** : Belt type: Radial
- RF** : Type: RunFlat
- 17** : Wheel diameter, inches
- 99** : Load index e.g. 99 is equivalent to 775 kg
- V** : Speed code letter

Speed code letter:

- Q** : up to 160 km/h
- S** : up to 180 km/h
- T** : up to 190 km/h
- H** : up to 210 km/h
- V** : up to 240 km/h
- W** : up to 270 km/h

Choose a tyre appropriate for the maximum speed of your vehicle.

The maximum speed is achievable at kerb weight with driver (75 kg) plus 125 kg payload. Optional equipment could reduce the maximum speed of the vehicle.

Performance ⇨ 245.

Directional tyres

Fit directional tyres such that they roll in the direction of travel. The rolling direction is indicated by a symbol (e.g. an arrow) on the sidewall.

Tyre pressure monitoring system

The tyre pressure monitoring system checks the pressure of all four tyres once a minute when vehicle speed exceeds a certain limit.

Caution

Tyre pressure monitoring system warns only about low tyre pressure condition and does not replace regular tyre maintenance by the driver.

All wheels must be equipped with pressure sensors and the tyres must have the prescribed pressure.

Note

In countries where the tyre pressure monitoring system is legally required, the use of wheels without pressure sensors will invalidate the vehicle operating permit.

The current tyre pressures can be shown in the **Vehicle Information Menu** in the Driver Information Centre.

The menu can be selected by the buttons on the turn signal lever.

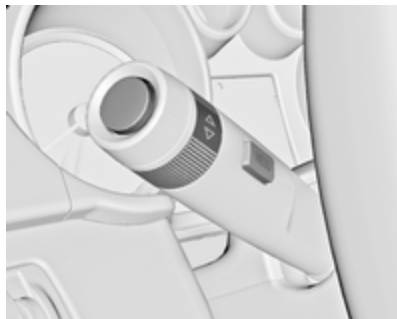

Press **MENU** to select the **Vehicle Information Menu** .

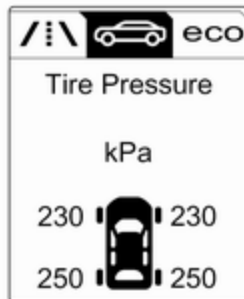



Turn the adjuster wheel to select the tyre pressure monitoring system.



System status and pressure warnings are displayed by a message indicating the corresponding tyre in the Driver Information Centre.

The system considers the tyre temperature for the warnings.

Temperature dependency  217.



A detected low tyre pressure condition is indicated by illumination of control indicator   94.

If  illuminates, stop as soon as possible and inflate the tyres as recommended  248.

If  flashes for 60-90 seconds then illuminates continuously, there is a fault in the system. Consult a workshop.

After inflating, driving may be required to update the tyre pressure values in the Driver Information Centre. During this time  may illuminate.

If \downarrow illuminates at lower temperatures and extinguishes after driving, this could be an indicator for approaching a low tyre pressure condition. Check tyre pressure.

Vehicle messages \rightarrow 103.

If the tyre pressure must be reduced or increased, switch off ignition.

Only mount wheels with pressure sensors, otherwise the tyre pressure will not be displayed and \downarrow illuminates continuously.

A spare wheel or temporary spare wheel is not equipped with pressure sensors. The tyre pressure monitoring system is not operational for these tyres. Control indicator \downarrow illuminates. For the further three wheels the system remains operational.

The use of commercially-available liquid tyre repair kits can impair the function of the system. Factory-approved repair kits can be used.

Operating electronic devices or being close to facilities using similar wave frequencies could disrupt the tyre pressure monitoring system.

Each time the tyres are replaced, tyre pressure sensors must be dismantled and serviced. For the screwed sensor: replace valve core and sealing ring. For clipped sensor: replace complete valve stem.

Vehicle loading status

Adjust tyre pressure to load condition according to the tyre information label or tyre pressure chart \rightarrow 248, and select the appropriate setting in the **Tyre load** menu in the Driver Information Centre \rightarrow 96. This setting is the reference for the tyre pressure warnings.

The menu **Tyre Load** only appears if the vehicle is at a standstill and the parking brake is applied. On vehicles with automatic transmission, the selector lever must be in **P**.

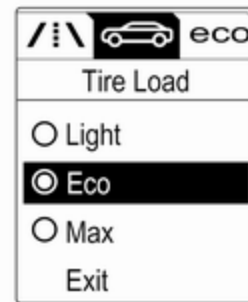

Select:

- **Light** for comfort pressure up to 3 people
- **Eco** for Eco pressure up to 3 people
- **Max** for full loading

Tyre pressure sensor matching process

Each tyre pressure sensor has a unique identification code. The identification code must be matched to a new wheel position after rotating the wheels or exchanging the complete wheel set and if one or more tyre pressure sensors were replaced.

The tyre pressure sensor matching process should also be performed after replacing a spare wheel with a road wheel containing a tyre pressure sensor.

The malfunction light (⚠) and the warning message or code should extinguish at the next ignition cycle. The sensors are matched to the wheel positions using a relearn tool, in the following order: left side front wheel, right side front wheel, right side rear wheel and left side rear wheel. The turn signal light at the current active position is illuminated until the sensor is matched.

Consult your workshop for service. There are two minutes to match the first wheel position, and five minutes overall to match all four wheel positions. If it takes longer, the matching process stops and must be restarted.

The tyre pressure sensor matching process is as follows:

1. Apply the parking brake.
2. Turn the ignition on.
3. On vehicles with automatic transmission: set the selector lever to **P**.
On vehicles with manual transmission: select neutral.
4. Use **MENU** on the turn signal lever to select the **Vehicle Information Menu** in the Driver Information Centre.
5. Turn the adjuster wheel to scroll to the tyre pressure menu.
6. Press **SET/CLR** to begin the sensor matching process. A message requesting acceptance of the process should be displayed.
7. Press **SET/CLR** again to confirm the selection. The horn sounds twice to indicate that the receiver is in relearn mode.
8. Start with the left side front wheel.
9. Place the relearn tool against the tyre sidewall, near the valve stem. Then press the button to activate the tyre pressure sensor. A horn chirp confirms that the sensor identification code has been matched to this wheel position.
10. Proceed to the right side front wheel, and repeat the procedure in Step 9.
11. Proceed to the right side rear wheel, and repeat the procedure in Step 9.
12. Proceed to the left side rear wheel, and repeat the procedure in Step 9. The horn sounds twice to indicate the sensor identification code has been matched to the left side rear tyre, and the tyre pressure sensor matching process is no longer active.
13. Turn off the ignition.
14. Set all four tyres to the recommended tyre pressure as indicated on the tyre pressure information label.
15. Ensure the tyre loading status is set according to the selected pressure ↗ 96.

Tyre pressure

Check the pressure of cold tyres at least every 14 days and before any long journey. Do not forget the spare wheel. This also applies to vehicles with tyre pressure monitoring system.



Tyre pressure ⇨ 248.

The tyre pressure information label on the left door frame indicates the original equipment tyres and the correspondent tyre pressures.

The tyre pressure data refers to cold tyres. It applies to summer and winter tyres.

Always inflate the spare tyre to the pressure specified for full load.

The ECO tyre pressure serves to achieve the smallest amount of fuel consumption possible.

Incorrect tyre pressures will impair safety, vehicle handling, comfort and fuel economy and will increase tyre wear.

Tyre pressures differ depending on various options. For the correct tyre pressure value, follow the procedure below:

1. Identify the engine identifier code.
Engine data ⇨ 244.
2. Identify the respective tyre.

The tyre pressure tables show all possible tyre combinations ⇨ 248.

For the tyres approved for your vehicle, refer to the EEC Certificate of Conformity provided with your vehicle or other national registration documents.

The driver is responsible for correct adjustment of tyre pressure.

⚠ Warning

If the pressure is too low, this can result in considerable tyre warm-up and internal damage, leading to tread separation and even to tyre blow-out at high speeds.

⚠ Warning

For specific tyres the recommended tyre pressure as shown in the tyre pressure table may exceed the maximum tyre pressure as indicated on the tyre. Never exceed the maximum tyre pressure as indicated on the tyre.

If the tyre pressure must be reduced or increased on a vehicle with tyre pressure monitoring system, switch off ignition. After adjusting tyre pressure switch on ignition and select the relevant setting on the page **Tyre load** in the Driver Information Centre ⇨ 96.

Temperature dependency

The tyre pressure depends on the temperature of the tyre. During driving, tyre temperature and pressure increase. Tyre pressure values provided on the tyre information label and tyre pressure chart are valid for cold tyres, which means at 20 °C.

The pressure increases by nearly 10 kPa for a 10 °C temperature increase. This must be considered when warm tyres are checked.

The tyre pressure value displayed in the Driver Information Centre shows the actual tyre inflation pressure. A cooled down tyre will show a decreased value, which does not indicate an air leak.

Tread depth

Check tread depth at regular intervals.

Tyres should be replaced for safety reasons at a tread depth of 2-3 mm (4 mm for winter tyres).

For safety reasons it is recommended that the tread depth of the tyres on one axle should not vary by more than 2 mm.



The legally permissible minimum tread depth (1.6 mm) has been reached when the tread has worn down as far as one of the tread wear indicators (TWI). Their position is indicated by markings on the sidewall.

If there is more wear at the front than the rear, swap round front wheels and rear wheels periodically. Ensure that the direction of rotation of the wheels is the same as before.

Tyres age, even if they are not used. We recommend tyre replacement every 6 years.

Changing tyre and wheel size

If tyres of a different size than those fitted at the factory are used, it may be necessary to reprogramme the speedometer as well as the nominal tyre pressure and make other vehicle modifications.

After converting to a different tyre size, have the label with tyre pressures replaced. ↻ 213

⚠ Warning

The use of unsuitable tyres or wheels may lead to accidents and will invalidate the vehicle operating permit.

Wheel covers

Wheel covers and tyres that are factory approved for the respective vehicle and comply with all of the relevant wheel and tyre combination requirements must be used.

If the wheel covers and tyres used are not factory approved, the tyres must not have a rim protection ridge.

Wheel covers must not impair brake cooling.

⚠ Warning

Use of unsuitable tyres or wheel covers could lead to sudden pressure loss and thereby accidents.

Vehicles with steel wheels: When using locking wheel nuts, do not attach wheel covers.

Tyre chains



Use tyre chains only on front wheels. Always use fine mesh chains that add no more than 10 mm to the tyre tread and the inboard sides (including chain lock).

⚠ Warning

Damage may lead to tyre blowout.

Tyre chains are permitted on tyres of sizes 225/55 R17 and 245/45 R18.

The use of tyre chains is not permitted on the temporary spare wheel.

Tyre repair kit

Minor damage to the tyre tread can be repaired with the tyre repair kit.

Do not remove foreign bodies from the tyres.

Tyre damage exceeding 4 mm or that is at tyre's sidewall cannot be repaired with the tyre repair kit.

⚠ Warning

Do not drive faster than 80 km/h.
Do not use for a lengthy period.
Steering and handling may be affected.

If you have a flat tyre:

Apply the parking brake and engage first gear, reverse gear or P.



The tyre repair kit is in a box under the floor cover in the load compartment.

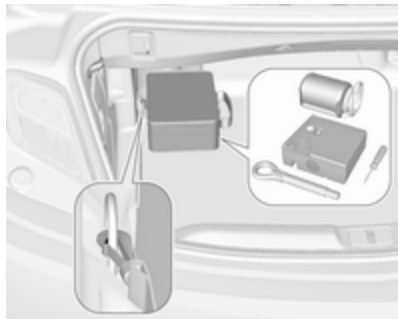

On another version, a bag with the tyre repair kit is fixed at the left rear lashing eye in the load compartment.

1. Take the tyre repair kit from the load compartment.
2. Remove the compressor.



3. Remove the electrical connection cable and air hose from the stowage compartments on the underside of the compressor.



4. Screw the compressor air hose to the connection on the sealant bottle.
5. Fit the sealant bottle into the retainer on the compressor.

Set the compressor near the tyre in such a way that the sealant bottle is upright.

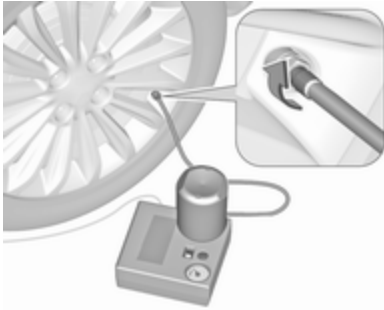

6. Unscrew valve cap from defective tyre.
7. Screw the filler hose to the tyre valve.
8. The switch on the compressor must be set to O.
9. Connect the compressor plug to the power outlet or cigarette lighter socket.

To avoid discharging the vehicle battery, we recommend running the engine.

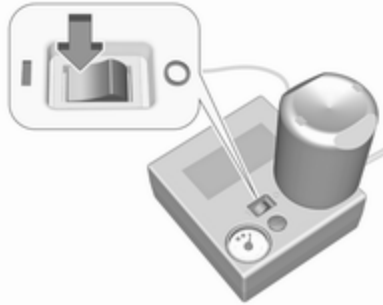

10. Set the rocker switch on the compressor to I. The tyre is filled with sealant.
11. The compressor pressure gauge briefly indicates up to 6 bar whilst the sealant bottle is emptying (approx. 30 seconds). Then the pressure starts to drop.
12. All of the sealant is pumped into the tyre. Then the tyre is inflated.
13. The prescribed tyre pressure should be obtained within 10 minutes. Tyre pressure ∇ 248. When the correct pressure is obtained, switch off the compressor.



If the prescribed tyre pressure is not obtained within 10 minutes, remove the tyre repair kit. Move the vehicle one tyre rotation. Reattach the tyre repair kit and continue the filling procedure for 10 minutes. If the prescribed tyre pressure is still not obtained, the tyre is too badly damaged. Seek the assistance of a workshop.

Drain excess tyre pressure with the button over the pressure indicator.

Do not run the compressor longer than 10 minutes.

14. Detach the tyre repair kit. Push catch on bracket to remove sealant bottle from bracket. Screw the tyre inflation hose to the free connection of the sealant bottle. This prevents sealant from escaping. Stow tyre repair kit in load compartment.
15. Remove any excess sealant using a cloth.
16. Take the label indicating maximum permitted speed from the sealant bottle and affix in the driver's field of view.
17. Continue driving immediately so that sealant is evenly distributed in the tyre. After driving approx. 10 km (but no more than 10 minutes), stop and check tyre pressure. Screw compressor air hose directly onto tyre valve and compressor when doing this.

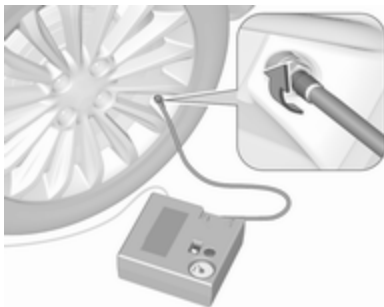

If tyre pressure is more than 1.3 bar, set it to the correct value. Repeat the procedure until there is no more loss of pressure.

If the tyre pressure has fallen below 1.3 bar, the vehicle must not be used. Seek the assistance of a workshop.

18. Stow away the tyre repair kit in the load compartment.

Note

The driving characteristics of the repaired tyre are severely affected, therefore have this tyre replaced.

If unusual noise is heard or the compressor becomes hot, turn compressor off for at least 30 minutes.

The built-in safety valve opens at a pressure of 7 bar.

Note the expiry date of the kit. After this date its sealing capability is no longer guaranteed. Pay attention to storage information on sealant bottle.

Replace the used sealant bottle. Dispose of the bottle as prescribed by applicable laws.

The compressor and sealant can be used from approx. -30 °C.

The adapters supplied can be used to pump up other items e.g. footballs, air mattresses, inflatable dinghies etc. They are located on the underside of the compressor. To remove, screw on compressor air hose and withdraw adapter.

Wheel changing

Some vehicles are equipped with a tyre repair kit instead of a spare wheel
 ⇨ 219.

Make the following preparations and observe the following information:

- Park the vehicle on a level, firm and non-slippery surface. The front wheels must be in the straight-ahead position.
- Apply the parking brake and engage first gear, reverse gear or **P**.
- Remove the spare wheel ⇨ 225.
- Never change more than one wheel at once.
- Use the jack only to change wheels in case of puncture, not for seasonal winter or summer tyre change.
- The jack is maintenance-free.
- If the ground on which the vehicle is standing is soft, a solid board (max. 1 cm thick) should be placed under the jack.
- Remove heavy objects from the vehicle before jacking up.
- No people or animals may be in the vehicle when it is jacked-up.
- Never crawl under a jacked-up vehicle.

- Do not start the vehicle when it is raised on the jack.
- Clean wheel nuts and thread with a clean cloth before mounting the wheel.

⚠ Warning

Do not grease wheel bolt, wheel nut and wheel nut cone.

1. Disengage wheel nut caps with a screwdriver and remove. Pull off the wheel cover. Vehicle tools ⇨ 212.

Alloy wheels: Disengage wheel nut caps with a screwdriver and remove. To protect the wheel, place a soft cloth between the screwdriver and the alloy wheel.

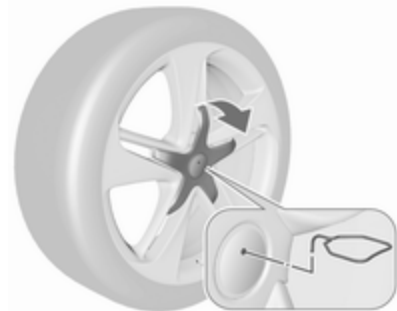

Alloy wheels with centre wheel bolt cap: Disengage centre cap by inserting and pulling the extractor ⇨ 212 in the recess of the brand emblem.

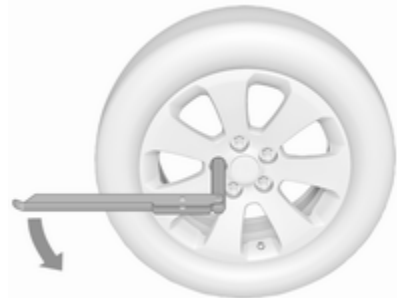

2. Install the wheel wrench ensuring that it locates securely and loosen each wheel nut by half a turn.

The wheels may be protected by locking wheel nuts. To loosen these specific nuts, first attach the adapter onto the head of the nut before installing the wheel wrench. The adapter is located in the glovebox.



3. Ensure the jack is correctly positioned under the relevant vehicle jacking point.

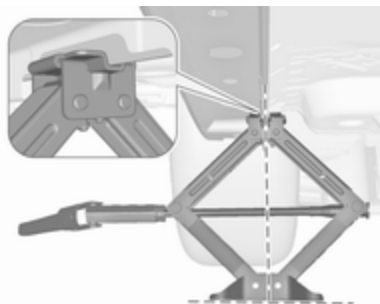

4. Set the jack to the necessary height. Position it directly below the jacking point in a manner that prevents it from slipping.



Attach wheel wrench and with the jack correctly aligned rotate wrench until wheel is clear of the ground.

5. Unscrew the wheel nuts.
6. Change the wheel. Spare wheel \diamond 225.
7. Screw on the wheel nuts.
8. Lower vehicle.
9. Install the wheel wrench ensuring that it is located securely and tighten each nut in a crosswise sequence. Tightening torque is 140 Nm.
10. Align the valve hole in the wheel cover with the tyre valve before installing.
Install wheel nut caps.
Install centre cap on alloy wheels.
11. Stow the replaced wheel \diamond 225, the vehicle tools \diamond 212 and the adapter for the locking wheel nuts \diamond 70.
12. Check the tyre pressure of the installed tyre and the wheel nut torque as soon as possible.

Have the defective tyre renewed or repaired as soon as possible.

Jacking position for lifting platform

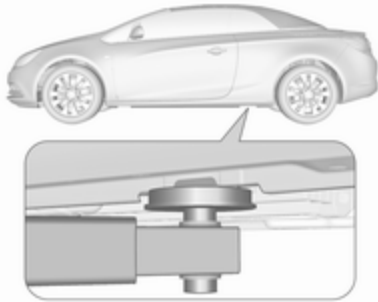

Rear arm position of the lifting platform centrally under the recess of the sill.

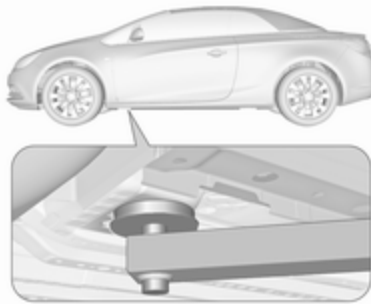

Front arm position of the lifting platform at the underbody.

Spare wheel

If mounting a spare wheel which is different from the other wheels, this wheel might be classified as a temporary spare wheel and the corresponding speed limits apply, even though no label indicates this. Seek the assistance of a workshop to check the applicable speed limit.

The spare wheel has a steel rim.

Caution

The use of a spare wheel that is smaller than the other wheels or used in combination with winter tyres could affect driveability. Have the defective tyre replaced as soon as possible.

Removing the spare wheel and stowing a damaged wheel in the load compartment

The spare wheel is located in the spare wheel well beneath the floor cover.

The spare wheel well is not designed for other tyre sizes than the spare wheel.

To remove:

1. Close the soft top and fold in the load compartment partition by pushing upwards at the loop area towards the inside ↻ 73.

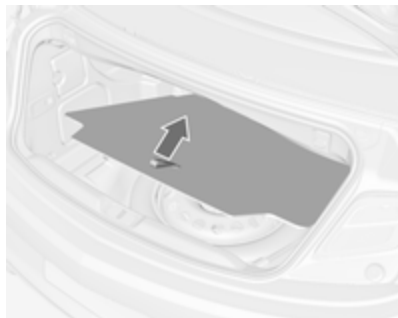

2. Remove the floor cover.



3. The spare wheel is secured with a wing nut in the well. Loosen nut, remove conus and remove the spare wheel.



Under the spare wheel there is a box and a bag with vehicle tools. The tool bag is secured with a tether to the stow rod. Remove tool box and tool bag tether from the stow rod to access the tools in the bag. Vehicle tools ⇨ 212.

4. Change the damaged wheel ⇨ 222 and stow the tools back in the tool box and the bag. Remove the strap from the box and put aside.

5. Attach the tool bag tether to the stow rod and place the bag in the well. Secure the tool box by installing the conical adapter and tightening wing nut.

6. Stow the damaged wheel facing upwards in the well.

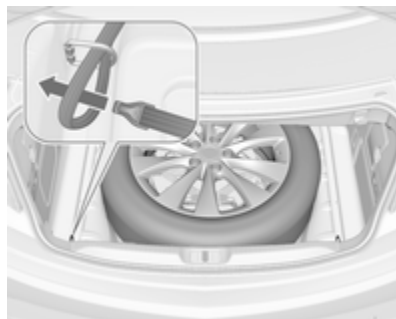

7. Place the loop end of the strap through the left rear lashing eye.

8. Place the hook end of the strap through the loop and pull it until the strap is fastened securely to the lashing eye.

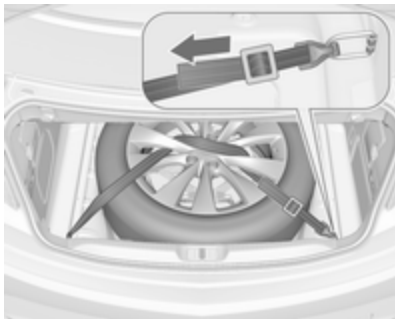

9. Insert the strap through the spokes of the wheel as shown in the illustration.
10. Mount the hook to the right rear lashing eye.
11. Tighten the strap and secure it using the buckle.
12. Place the floor cover over the damaged wheel.
13. If equipped, secure coupling ball bar in the bag to a lashing eye in the load compartment.
14. Fold out the load compartment partition before opening the soft top.

Stowing the spare wheel back in the well after replacing the damaged wheel

1. Close the soft top and fold in the load compartment partition.
2. Remove floor cover, loosen and remove wing nut and conus.
3. Stow the tools in the tool box and the bag.
4. Place spare wheel facing upwards in the well.

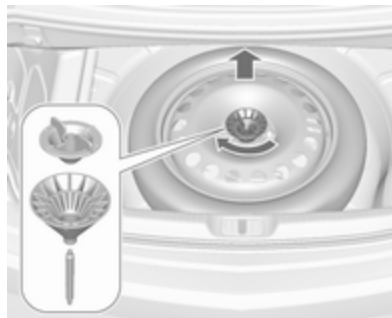

5. Insert and turn the excentric conus in the recess of the spare wheel so that the wheel is positioned as far as possible

towards the front. Secure the wheel by turning the wing nut clockwise.

6. Insert and close floor cover.

⚠ Warning

Storing a jack, a wheel or other equipment in the load compartment could cause injury if they are not secured properly. During a sudden stop or a collision, loose equipment could cause personal injury or damage to the load or vehicle.

Always store jack and tools in the respective storage compartments and secure them by fixing.

Damaged wheel placed in the load compartment must always be secured with the strap.

Temporary spare wheel

Caution

The use of a spare wheel that is smaller than the other wheels or in combination with winter tyres could affect driveability. Have the defective tyre replaced as soon as possible.

Only mount one temporary spare wheel. Do not drive faster than 80 km/h. Take curves slowly. Do not use for a long period of time.

If your vehicle gets a flat tyre on the rear while towing another vehicle, mount the temporary spare wheel at the front and the full size tyre at the rear.

Tyre chains ⇨ 219.

Spare wheel with directional tyre

Fit directional tyres such that they roll in the direction of travel. The rolling direction is indicated by a symbol (e.g. an arrow) on the sidewall.

The following applies to tyres fitted opposing the rolling direction:

- Driveability may be affected. Have the defective tyre renewed or repaired as soon as possible and fit it instead of the spare wheel.
- Drive particularly carefully on wet and snow-covered road surfaces.

Jump starting

Do not start with quick charger.

A vehicle with a discharged vehicle battery can be started using jump leads and the vehicle battery of another vehicle.

Warning

Be extremely careful when starting with jump leads. Any deviation from the following instructions can lead to injuries or damage caused by battery explosion or damage to the electrical systems of both vehicles.

Warning

Avoid contact of the battery with eyes, skin, fabrics and painted surfaces. The fluid contains sulphuric acid which can cause injuries and damage in the event of direct contact.

- Never expose the battery to naked flames or sparks.

- A discharged vehicle battery can already freeze at a temperature of 0 °C. Defrost the frozen battery before connecting jump leads.
- Wear eye protection and protective clothing when handling a battery.
- Use a booster battery with the same voltage (12 Volts). Its capacity (Ah) must not be much less than that of the discharged battery.
- Use jump leads with insulated terminals and a cross section of at least 16 mm² (25 mm² for diesel engines).
- Do not disconnect the discharged battery from the vehicle.
- Switch off all unnecessary electrical consumers.
- Do not lean over the battery during jump starting.
- Do not allow the terminals of one lead to touch those of the other lead.
- The vehicles must not come into contact with each other during the jump starting process.

- Apply the parking brake, transmission in neutral, automatic transmission in **P**.
- Open the positive terminal protection caps of both batteries.

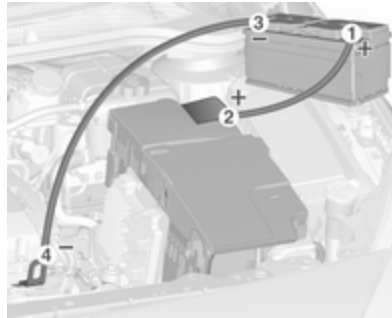

Lead connection order:

1. Connect the red lead to the positive terminal of the booster battery.
2. Connect the other end of the red lead to the positive terminal of the discharged battery.

3. Connect the black lead to the negative terminal of the booster battery.
4. Connect the other end of the black lead to a vehicle grounding point, such as the engine block or an engine mounting bolt. Connect as far away from the discharged battery as possible, however at least 60 cm.

Route the leads so that they cannot catch on rotating parts in the engine compartment.

To start the engine:

1. Start the engine of the vehicle providing the jump.
2. After 5 minutes, start the other engine. Start attempts should be made for no longer than 15 seconds at an interval of 1 minute.
3. Allow both engines to idle for approx. 3 minutes with the leads connected.

4. Switch on electrical consumers (e.g. headlights, heated rear window) of the vehicle receiving the jump start.
5. Reverse above sequence exactly when removing leads.

Towing

Towing the vehicle



Wrap a cloth around the tip of a flat screwdriver to prevent paint damage. Insert the screwdriver in the slot at the lower part of the cap. Release the cap by carefully moving the screwdriver downwards.

The towing eye is stowed with the vehicle tools ↗ 212.



Screw in the towing eye anticlockwise as far as it will go until it stops in a horizontal position.

Attach a tow rope – or better still a tow rod – to the towing eye.

The towing eye must only be used for towing and not for recovering the vehicle.

Switch on ignition to release steering wheel lock and to permit operation of brake lights, horn and windscreen wiper.

Switch the selector lever to neutral.

Release the parking brake.

Caution

Drive slowly. Do not drive jerkily. Excessive tractive force can damage the vehicle.

When the engine is not running, considerably more force is needed to brake and steer.

To prevent the entry of exhaust gases from the towing vehicle, switch on the air recirculation and close the windows, when soft top is closed.

Vehicles with automatic transmission: The vehicle must be towed facing forwards, not faster than 80 km/h nor further than 100 km. In all other cases and when the transmission is defective, the front axle must be raised off the ground.

Seek the assistance of a workshop.

After towing, unscrew the towing eye clockwise.

Insert cap at the top and engage downwards.

Towing another vehicle



Wrap a cloth around the tip of a flat screwdriver to prevent paint damage. Insert the screwdriver in the slot at the lower bend of the cap. Release the cap by carefully moving the screwdriver downwards.

The towing eye is stowed with the vehicle tools ↪ 212.



Screw in the towing eye anticlockwise as far as it will go until it stops in a horizontal position.

The lashing eye at the rear underneath the vehicle must never be used as a towing eye.

Attach a tow rope – or even better a tow bar – to the towing eye.

The towing eye must only be used for towing and not for recovering a vehicle.

Caution

Drive slowly. Do not drive jerkily. Excessive tractive force can damage the vehicle.

After towing, unscrew the towing eye clockwise.

Insert cap at the top and engage downwards.

Appearance care**Exterior care****Locks**

The locks are lubricated at the factory using a high quality lock cylinder grease. Use de-icing agent only when absolutely necessary, as this has a degreasing effect and impairs lock function. After using a de-icing agent, have the locks regreased by a workshop.

Washing

The paintwork of your vehicle is exposed to environmental influences, therefore wash your vehicle regularly.

When using automatic vehicle washes, we recommend one with textile brushes and a programme without wax additives.

When doing a hand wash, use clear water and a soft brush, cleaning in the grain direction of the textile hood.

Never use a steam-jet or high-pressure jet cleaner for the soft top or the engine compartment.

Wax painted parts of the vehicle regularly.

Bird droppings, dead insects, resin, pollen and the like should be cleaned off immediately, as they contain aggressive constituents which can cause paint and fabric damage.

If using a vehicle wash, comply with the vehicle wash manufacturer's instructions. The windscreen wiper must be switched off. Remove additional antenna and external accessories.

If you wash your vehicle by hand, make sure that the insides of the wheel housings are also thoroughly rinsed out.

Clean edges and folds on opened doors and the bonnet as well as the areas they cover.

Clean bright metal mouldings with a cleaning solution approved for aluminium to avoid damage.

Caution

Always use a cleaning agent with a pH value of four to nine.
Do not use cleaning agents on hot surfaces.

Caution

After washing or cleaning, the soft top must be completely dried before opening. If a wet soft top remains opened for a longer time, it would be damaged by water spotting and mould growth.

When cleaning with a high-pressure jet cleaner ensure a minimum distance of 30 cm to the rear brand emblem to prevent unintended unlocking.

Thoroughly rinse and leather-off the vehicle. Rinse leather frequently. Use separate leathers for painted and glass surfaces: remnants of wax on the windows will impair vision.

Have the door hinges of all doors greased by a workshop.

Do not use hard objects to remove spots of tar. Use tar removal spray on painted surfaces.

Exterior lights

Headlight and other light covers are made of plastic. Do not use any abrasive or caustic agents, do not use an ice scraper, and do not clean them dry.

Polishing and waxing

Wax painted parts of the vehicle regularly (at the latest when water no longer beads). Otherwise, the paintwork will dry out.

Polishing is necessary only if the paint has become dull or if solid deposits have become attached to it.

Paintwork polish with silicone forms a protective film, making waxing unnecessary.

Soft top as well as plastic body parts must not be treated with wax or polishing agents.

Windows and windscreen wiper blades

Use a soft lint-free cloth or chamois leather together with window cleaner and insect remover.

When cleaning the rear window from inside, always wipe in parallel to the heating element to prevent damage.

For mechanical removal of ice, use a sharp-edged ice scraper. Press the scraper firmly against the glass so that no dirt can get under it and scratch the glass.

Remove dirt residues from smearing wiper blades by using a soft cloth and window cleaner. Also make sure to remove any residues such as wax, insect residues and similar from the window.

Ice residues, pollution and continuous wiping on dry windows will damage or even destroy the wiper blades.

Wheels and tyres

Do not use high-pressure jet cleaners.

Clean rims with a pH-neutral wheel cleaner.

Rims are painted and can be treated with the same agents as the body.

Paintwork damage

Rectify minor paintwork damage with a touch-up pen before rust forms. Have more extensive damage or rust areas repaired by a workshop.

Underbody

Some areas of the vehicle underbody have a PVC undercoating while other critical areas have a durable protective wax coating.

After the underbody is washed, check the underbody and have it waxed if necessary.

Bitumen/rubber materials could damage the PVC coating. Have underbody work carried out by a workshop.

Before and after winter, wash the underbody and have the protective wax coating checked.

Towing equipment

Do not clean the coupling ball bar with a steam-jet or high-pressure jet cleaner.

Interior care

Interior and upholstery

Only clean the vehicle interior, including the instrument panel fascia and panelling, with a dry cloth or interior cleaner.

Clean the leather upholstery with clear water and a soft cloth. In case of heavy soiling, use leather care.

The instrument cluster and the displays should only be cleaned using a soft damp cloth. If necessary use a weak soap solution.

Clean fabric upholstery with a vacuum cleaner and brush. Remove stains with an upholstery cleaner.

Clothing fabrics may not be colourfast. This could cause visible discolourations, especially on light-

coloured upholstery. Removable stains and discolourations should be cleaned as soon as possible.

Clean seat belts with lukewarm water or interior cleaner.

Caution

Close Velcro fasteners as open Velcro fasteners on clothing could damage seat upholstery.

The same applies to clothing with sharp-edged objects, like zips or belts or studded jeans.

Plastic and rubber parts

Plastic and rubber parts can be cleaned with the same cleaner as used to clean the body. Use interior cleaner if necessary. Do not use any other agent. Avoid solvents and petrol in particular. Do not use high-pressure jet cleaners.

Service and maintenance

General information	235
Service information	235
Recommended fluids, lubricants and parts	236
Recommended fluids and lubricants	236

General information

Service information

In order to ensure economical and safe vehicle operation and to maintain the value of your vehicle, it is of vital importance that all maintenance work is carried out at the proper intervals as specified.

The detailed, up-to-date service schedule for your vehicle is available at the workshop.

Service display ⇨ 87.

European service intervals

Maintenance of your vehicle is required every 30,000 km or after 1 year, whichever occurs first, unless otherwise indicated in the service display.

A shorter service interval can be valid for severe driving behaviour, e.g. for taxis and police vehicles.

The European service intervals are valid for the following countries:

Andorra, Austria, Belgium, Bosnia-Herzegovina, Bulgaria, Croatia, Cyprus, Czech Republic, Denmark, Estonia, Finland, France, Germany, Greece, Greenland, Hungary, Iceland, Ireland, Italy, Latvia, Liechtenstein, Lithuania, Luxembourg, Macedonia, Malta, Monaco, Montenegro, Netherlands, Norway, Poland, Portugal, Romania, San Marino, Serbia, Slovakia, Slovenia, Spain, Sweden, Switzerland, United Kingdom.

Service display ⇨ 87.

International service intervals

Maintenance of your vehicle is required every 15,000 km or after 1 year, whichever occurs first, unless otherwise indicated in the service display.

Severe operating conditions exist if one or more of the following circumstances occur frequently: Cold starting, stop and go operation, trailer operation, mountain driving, driving on poor and sandy road surfaces, increased air pollution, presence of airborne sand and high dust content,

driving at high altitude and large variations of temperature. Under these severe operating conditions, certain service work may be required more frequently than the regular service interval.

The international service intervals are valid for the countries which are not listed in the European service intervals.

Service display ⇨ 87.

Confirmations

Confirmation of service is recorded in the Service and Warranty Booklet. The date and mileage is completed with the stamp and signature of the servicing workshop.

Make sure that the service and warranty booklet is completed correctly as continuous proof of service is essential if any warranty or goodwill claims are to be met, and is also a benefit when selling the vehicle.

Service interval with remaining engine oil life duration

The service interval is based on several parameters depending on usage.

The service display lets you know when to change the engine oil.

Service display ⇨ 87.

Recommended fluids, lubricants and parts

Recommended fluids and lubricants

Only use products that meet the recommended specifications.

Warning

Operating materials are hazardous and could be poisonous. Handle with care. Pay attention to information given on the containers.

Engine oil

Engine oil is identified by its quality and its viscosity. Quality is more important than viscosity when selecting which engine oil to use. The oil quality ensures e.g. engine cleanliness, wear protection and oil aging control, whereas viscosity grade gives information on the oil's thickness over a temperature range.

Dexos is the newest engine oil quality that provides optimum protection for petrol and diesel engines. If it is unavailable, engine oils of other listed qualities must be used.

Select the appropriate engine oil based on its quality and on the minimum ambient temperature ⇨ 241.

Topping up engine oil

Caution
In case of any spilled oil, wipe it up and dispose it properly.

Engine oils of different manufacturers and brands can be mixed as long as they comply with the required engine oil quality and viscosity.

Use of engine oils for all petrol engines with only ACEA quality is prohibited, since it can cause engine damage under certain operating conditions.

Select the appropriate engine oil based on its quality and on the minimum ambient temperature ⇨ 241.

Additional engine oil additives

The use of additional engine oil additives could cause damage and invalidate the warranty.

Engine oil viscosity grades

The SAE viscosity grade gives information on the thickness of the oil.

Multigrade oil is indicated by two figures, e.g. SAE 5W-30. The first figure, followed by a W, indicates the low temperature viscosity and the second figure the high temperature viscosity.

Select the appropriate viscosity grade depending on the minimum ambient temperature ⇨ 241.

All of the recommended viscosity grades are suitable for high ambient temperatures.

Coolant and antifreeze

Use only organic acid type-long life coolant (LLC) antifreeze approved for the vehicle. Consult a workshop.

The system is factory filled with coolant designed for excellent corrosion protection and frost protection down to approx. -28 °C. In cold regions with very low temperatures the factory filled coolant provides frost protection down to approx. -37 °C. This concentration should be maintained all year round. The use of additional coolant additives that intend to give additional corrosion protection or seal against minor leaks can cause function problems. Liability for consequences resulting from the use of additional coolant additives will be rejected.

Washer fluid

Only use washer fluid approved for the vehicle to prevent damage of wiper blades, paintwork, plastic and rubber parts. Consult a workshop.

Brake and clutch fluid

Over time, brake fluid absorbs moisture which will reduce braking effectiveness. The brake fluid should therefore be replaced at the specified interval.

AdBlue

Only use AdBlue to reduce the nitrogen oxides in the exhaust emission ↪ 145.

Information on identification label:

- 1** : Manufacturer
- 2** : Type approval number
- 3** : Vehicle Identification Number
- 4** : Permissible gross vehicle weight rating in kg
- 5** : Permissible gross train weight in kg
- 6** : Maximum permissible front axle load in kg
- 7** : Maximum permissible rear axle load in kg
- 8** : Vehicle-specific or country-specific data

The combined total of front and rear axle loads must not exceed the permissible gross vehicle weight. For example, if the front axle is bearing its maximum permissible load, the rear axle can only bear a load that is equal to the gross vehicle weight minus the front axle load.

The technical data is determined in accordance with European Community standards. We reserve the right to make modifications. Specifications in the vehicle documents always have priority over those given in this manual.

Engine identification

The technical data tables show the engine identifier code. Engine data ⇨ 244.

To identify the respective engine, refer to the engine power in the EEC Certificate of Conformity provided with your vehicle or other national registration documents.

Vehicle data

Recommended fluids and lubricants

European service schedule

Required engine oil quality

All European countries with European service interval ⇨ 235

Engine oil quality	Petrol engine B14NET	All other petrol engines (including CNG, LPG, E85)	Diesel engines
dexos1 Gen2	✓	–	–
dexos2	–	✓	✓

All engines except B14NET: In case dexos quality is unavailable, you may not use max. one litre engine oil quality ACEA C3 once between each oil change.

Engine oil viscosity grades

All European countries with European service interval ⇨ 235

Ambient temperature	Petrol and diesel engines
down to -25 °C	SAE 0W-30 or SAE 0W-40 SAE 5W-30 or SAE 5W-40
below -25 °C	SAE 0W-30 or SAE 0W-40

International service schedule

Required engine oil quality

All countries with international service interval ⇨ 235

Engine oil quality	Petrol engine B14NET	All other petrol engines (including CNG, LPG, E85)	Diesel engines
dexos1 Gen2	✓	–	–
dexos2	–	✓	✓

In case dexos quality is unavailable you may use the oil qualities listed below:

All countries with international service interval ⇨ 235

Engine oil quality	Petrol engine B14NET	All other petrol engines (including CNG, LPG, E85)	Diesel engines
ACEA A3/B4	–	✓	✓
ACEA C3	–	✓	✓

Engine oil viscosity grades

All countries with international service interval ⇨ 235

Ambient temperature	Petrol and diesel engines
down to -25 °C	SAE 0W-30 or SAE 0W-40 SAE 5W-30 or SAE 5W-40
below -25 °C	SAE 0W-30 or SAE 0W-40
down to -20 °C	SAE 10W-30 ¹⁾ or SAE 10W-40 ¹⁾

1) Permitted, but usage of oils with dexos quality is recommended.

Engine data

Sales designation	1.4 Turbo	1.4 Turbo	1.6 Turbo	1.6 Turbo	2.0 CDTI
Engine identifier code	B14NEL	B14NET	B16SHL	B16SHT	B20DTH
Engineering code	B14NET	B14NET	B16SHT	B16SHT	B20DTH
Piston displacement [cm ³]	1364	1364	1598	1598	1956
Engine power [kW]	88	103	125	147	125
at rpm	4200-6000	4900-6000	4750-6000	5500	3750
Torque [Nm]	200	200	260	280	400
at rpm	1850-4200	1850-4900	1650-4500	1650-5000	1750-2500
Fuel type	Petrol	Petrol	Petrol	Petrol	Diesel
Octane rating RON ²⁾					
recommended	95	95	98	98	
possible	98	98	95	95	
possible	91	91	91	91	

2) A country-specific label at the fuel filler flap can supersede the engine-specific requirement.

Performance

Engine	B14NEL	B14NET	B16SHT	B16SHL	B20DTH
Maximum speed [km/h]					
Manual transmission	195	207	235	–	135
Automatic transmission	–	–	–	219	–

Vehicle weight

Kerb weight, basic model without any optional equipment

	Engine	Manual transmission	Automatic transmission
without/with air conditioning [kg]	B14NEL	1701 / 1714	–
	B14NET	1701 / 1714	–
	B16SHT	– / 1733	–
	B16SHL	–	– / 1733
	B20DTH	– / 1843	–

Optional equipment and accessories increase the kerb weight.

Loading information ⇨ 77.

Vehicle dimensions

Length [mm]	4696
Length max. when operating soft top [mm]	4760
Width without exterior mirrors [mm]	1839
Width with two exterior mirrors [mm]	2020
Height (without antenna) [mm]	1443
Height max. when operating soft top [mm]	2103
Length of load compartment floor [mm]	1121
Length of load compartment with folded rear seats [mm]	1818
Load compartment width [mm]	978
Load compartment height [mm] with opened soft top	246
Load compartment height [mm] with closed soft top	453
Wheelbase [mm]	2695
Turning circle diameter [m]	12.2

Capacities

Engine oil

Engine	B14NEL, B14NET	B16SHT, B16SHL	B20DTH
including filter [l]	4.0	5.5	5,25
between MIN and MAX [l]	1.0	1.0	1,0

Fuel tank

Petrol/diesel, refill quantity [l]	46 (ECOTEC version) 56
------------------------------------	---------------------------

AdBlue tank

AdBlue, refilling quantity [l]	7.5
--------------------------------	-----

Tyre pressures

Engine	Tyres	Comfort with up to 3 people		ECO with up to 3 people		With full load	
		front [kPa/bar] ([psi])	rear [kPa/bar] ([psi])	front [kPa/bar] ([psi])	rear [kPa/bar] ([psi])	front [kPa/bar] ([psi])	rear [kPa/bar] ([psi])
B14NEL, B14NET,	235/55 R17,	230/2.3 (34)	230/2.3 (34)	280/2.8 (41)	280/2.8 (41)	240/2.4 (35)	280/2.8 (41)
B16SHT, B16SHL	235/50 R18, 245/45 R18, 235/45 R19, 245/40 R20, 225/55 R17						

Engine	Tyres	Comfort with up to 3 people		ECO with up to 3 people		With full load	
		front	rear	front	rear	front	rear
		[kPa/bar] ([psi])	[kPa/bar] ([psi])	[kPa/bar] ([psi])	[kPa/bar] ([psi])	[kPa/bar] ([psi])	[kPa/bar] ([psi])
B20DTH,	235/55 R17,	250/2.5 (36)	230/2.3 (34)	280/2.8 (41)	280/2.8 (41)	260/2.6 (38)	300/3.0 (44)
	235/50 R18,						
	245/45 R18,						
	235/45 R19,						
	245/40 R20,						
	225/55 R17						
All	Temporary spare wheel 125/70 R17	420/4.2 (61)	420/4.2 (61)	–	–	420/4.2 (61)	420/4.2 (61)

Customer information

Customer information	250
Declaration of conformity	250
REACH	254
Software acknowledgement	254
Registered trademarks	256
Vehicle data recording and privacy	256
Event data recorders	256
Radio Frequency Identification (RFID)	259

Customer information

Declaration of conformity

Radio transmission systems

This vehicle has systems that transmit and / or receive radio waves subject to Directive 1999/5/EC or 2014/53/EU. The manufacturers of the systems listed below declare conformity with Directive 1999/5/EC or 2014/53/EU. The full text of the EU declaration of conformity for each system is available at the following internet address: www.opel.com/conformity

Importer is
Opel / Vauxhall, Bahnhofspatz,
65423 Ruesselsheim am Main,
Germany.

Infotainment system Navi 950 / Navi 650 / CD 600

Panasonic Automotive & Industrial
Systems Europe GmbH
Robert-Bosch-Straße 27-29,
D-63225 Langen, Germany

Operation frequency (MHz)	Maximum output (dBm)
---------------------------	----------------------

2402.0 - 2480.0	7.67
-----------------	------

Infotainment system CD 300 / CD 400

Panasonic Automotive & Industrial
Systems Europe GmbH
Robert-Bosch-Straße 27-29,
D-63225 Langen, Germany

Operation frequency (MHz)	Maximum output (dBm)
---------------------------	----------------------

N/A	N/A
-----	-----

DAB+ Module

Panasonic Automotive & Industrial
Systems Europe GmbH
Robert-Bosch-Straße 27-29,
D-63225 Langen, Germany

Operation frequency: N/A

Maximum output: N/A

Antenna Laird

Laird

Daimlerring 31, D-31135 Hildesheim,
Germany

Operation frequency: N/A

Maximum output: N/A

Antenna Kathrein

Kathrein Automotive GmbH

Roemerring 1, D-31137 Hildesheim,
Germany

Operation frequency: N/A

Maximum output: N/A

OnStar module

LG Electronics European Shared
Service center B.V.

Krijgsman 1, 1186 DM Amstelveen,
The Netherlands

Operation frequency (MHz)	Maximum output (dBm)
---------------------------	----------------------

2402 - 2480	4
-------------	---

2412 - 2462	18
-------------	----

880 - 915	33
-----------	----

1710 - 1785	24
-------------	----

1850 - 1910	24
-------------	----

1920 - 1980	24
-------------	----

2500 - 2570	23
-------------	----

Immobiliser

Continental Automotive GmbH

Siemensstrasse 12, D-93055
Regensburg, Germany

Operation frequency: 125 kHz

Maximum output:

5.1 dBuA/m @ 10m

Radio remote control receiver

Continental Automotive GmbH

Siemensstrasse 12, D-93055
Regensburg, Germany

Operation frequency: N/A

Maximum output: N/A

Radio remote control transmitter

Continental Automotive GmbH

Siemensstrasse 12, D-93055
Regensburg, Germany

Operation frequency: 433.92 MHz

Maximum output: -5,7 dBm

Tyre pressure sensors

Schrader Electronics Ltd.

11 Technology Park, Belfast Road,
Antrim BT41 1QS, Northern Ireland,
United Kingdom

Operation frequency: 433.92 MHz

Maximum output: 10 dBm

Parking heater remote control receiver

Webasto Thermo & Comfort SE

Friedrichshafener Str. 9, D-82205
Gilching, Germany

Operation frequency: N/A

Maximum output: N/A

Parking heater remote control transmitter

Webasto Thermo & Comfort SE

Friedrichshafener Str. 9, D-82205
Gilching, Germany

Operation frequency: 869.0 MHz

Maximum output: 14 dBm

Radar systems

Country-specific Declarations of
Conformity for radar systems are
shown on the following page:

European Union

EC Directive: 1999/5/EC

Manufacturer: Delphi Electronics & Safety

Model / Type Designation: L2C0038TR

Description / Intended Use:

Electronically Scanned Radar (ESR),
a 76.5GHz adaptive cruise control system
radar fitted to motor vehicles at vehicle
manufacture

Applied Standards:

47 CFR Part 15

CEPT ERC Recommendation 70-03

EN 60950

EN 301 091

European Commission Directive

2006/28/EC

I declare that the product referenced
above is in compliance with the essential
requirements and other relevant
provisions of Directive 1999/5/EC, on the
approximation of the laws of the member
states relating to Directive 1999/5/EC.

Brazil

Modelo: L2C0038TR



1071-10-3451



0107897843800248

Este equipamento
opera em caráter
secundário, isto é,
não tem direito a
proteção contra
interferência

prejudicial, mesmo de estações do
mesmo tipo, e não pode causar
interferência a sistemas operando em
caráter primário

Indonesia

14785/POSTEL/2010

1982

Jordan

Type Approval No.: TRC/LPD/2009/87

Equipment Type: Low Power Device (LPD)

Malaysia

Approval #: B 05358

Moldova

8526

Morocco

AGREE PAR L'ANRT MAROC

Numéro d'agrément :

MR 4838 ANRT 2009

Date d'agrément : 22/5/2009

Singapore

Complies with

IDA Standards

DA105753

South Africa

TA-2009/163

APPROVED

South Korea**Taiwan**

◎ CCAB09LP4590T3

UAE

TRA

REGISTERED No:

0018923/09

DEALER No:

DA0047809/10

United States of America and Canada

Model / FCC ID: L2C0038TR IC: 3432A-0038TR

This device complies with Part 15 of the FCC Rules
and with Industry Canada license-exempt RSS
standard(s). Operation is subject to the following
two conditions: (1) This device may not cause
harmful interference, and (2) This device must
accept any interference received, including
interference that may cause undesired operation.

Le présent appareil est conforme aux CNR
d'industrie Canada applicables aux appareils
radio exempts de licence. L'exploitation est
autorisée aux deux conditions suivantes: (1)
l'appareil ne doit pas produire de brouillage, et
(2) l'utilisateur de l'appareil doit accepter tout
brouillage radioélectrique subi, même si le
brouillage est susceptible d'en compromettre le
fonctionnement.

Note: Changes or modifications not expressly
approved by the party responsible for compliance
could void the user's authority to operate the
equipment. The term "IC:" before the radio
certification number only signifies that Industry
Canada technical specifications were met.

Note: This equipment complies with radiation
exposure limits set forth for an uncontrolled
environment. This equipment should be installed
and operated with minimum distance of 20 cm
between the radiator and your body.

Jack



Wir lieben Autos.

Konformitätserklärung

nach EG Richtlinie 2006/42/EG

Hiermit erklären wir, dass das Produkt:

Produktbezeichnung: Wagenheber**Typ/GM-Teilenummern:** 13348505, 13504504

den Bestimmungen der Richtlinie 2006/42/EG entspricht.

Angewendete technische Normen:

GMW9237 Jacking
 GM 14337 Standard Equipment Jack - Hardware Treads
 GMW5127 Vehicle Integrity-Hoisting and Service Station Jacking
 GMW15005 Standard Equipment Jack and Spare Tire, Vehicle Test
 ISO TS 16949 Qualitätsmanagementsystem

Der Unterzeichner ist Bevollmächtigter für die Zusammenstellung der technischen Unterlagen.

Rüsselsheim, 31. Januar 2014

Hans-Peter Metzger
 Engineering Group Manager Chassis & Structure
 Adium Opel AG

Adium Opel AG
 64222 Rüsselsheim
 Telefon: 421 31 18 11 / 421 3 88 00
 www.opel.de

Vertrauens- / Technik- / Marken- / Sachverständigen- /
 Sachverständiger / Adium- / Adium- /
 Michael Lohschulte, Dr. Thomas Schäfer,
 Peter Thies, Susanne Weidner, Julian Willms

Aufsichtsrat
 Jürgen L. Grogg (Vorsitzender)

Sitz der Geschäftsleitung
 Adium- / Adium- /
 Adium- / Adium- /
 Adium- / Adium- /
 Adium- / Adium- /

Translation of the original declaration of conformity

Declaration of conformity according to EC Directive 2006/42/EC

We declare that the product:

Product designation: Jack

Type/GM part number: 13348505, 13504504

is in compliance with the provisions of Directive 2006/42/EC.

Applied technical standards:

- GMN9737 : Jacking
- GM 14337 : Standard Equipment Jack – Hardware Tests
- GMN5127 : Vehicle Integrity – Hoisting and Service Station Jacking
- GMW15005 : Standard Equipment Jack and Spare Tire, Vehicle Test
- ISO TS 16949 : Quality management systems

The signatory is authorised to compile the technical documentation.

Rüsselsheim, 31st January 2014

signed by

Hans-Peter Metzger

Engineering Group Manager Chassis & Structure

Adam Opel AG

D-65423 Rüsselsheim

REACH

Registration, Evaluation, Authorisation and Restriction of Chemicals (REACH) is a European Union regulation adopted to improve the protection of human health and the environment from the risks that can be posed by chemicals. Visit www.opel.com/reach for further information and for access to the Article 33 communication.

Software acknowledgement

Certain OnStar components include libcurl and unzip software and other third party software. Below are the notices and licenses associated with libcurl and unzip and for other third party software please see <http://www.lg.com/global/support/opensource/index>.

libcurl

Copyright and permission notice
Copyright (c) 1996 - 2010, Daniel Stenberg, <daniel@haxx.se>.

All rights reserved.

Permission to use, copy, modify, and distribute this software for any purpose with or without fee is hereby granted, provided that the above copyright notice and this permission notice appear in all copies.

The software is provided "as is", without warranty of any kind, express or implied, including but not limited to the warranties of merchantability, fitness for a particular purpose and noninfringement of third party rights. In no event shall the authors or

copyright holders be liable for any claim, damages or other liability, whether in an action of contract, tort or otherwise, arising from, out of or in connection with the software or the use or other dealings in the software.

Except as contained in this notice, the name of a copyright holder shall not be used in advertising or otherwise to promote the sale, use or other dealings in this Software without prior written authorization of the copyright holder.

unzip

This is version 2005-Feb-10 of the Info-ZIP copyright and license. The definitive version of this document should be available at <ftp://ftp.info-zip.org/pub/infozip/license.html> indefinitely.

Copyright (c) 1990-2005 Info-ZIP. All rights reserved.

For the purposes of this copyright and license, "Info-ZIP" is defined as the following set of individuals:

Mark Adler, John Bush, Karl Davis, Harald Denker, Jean-Michel Dubois, Jean-loup Gailly, Hunter Goatley, Ed

Gordon, Ian Gorman, Chris Herborth, Dirk Haase, Greg Hartwig, Robert Heath, Jonathan Hudson, Paul Kienitz, David Kirschbaum, Johnny Lee, Onno van der Linden, Igor Mandrichenko, Steve P. Miller, Sergio Monesi, Keith Owens, George Petrov, Greg Roelofs, Kai Uwe Rommel, Steve Salisbury, Dave Smith, Steven M. Schweda, Christian Spieler, Cosmin Truta, Antoine Verheijen, Paul von Behren, Rich Wales, Mike White.

This software is provided "as is," without warranty of any kind, express or implied. In no event shall Info-ZIP or its contributors be held liable for any direct, indirect, incidental, special or consequential damages arising out of the use of or inability to use this software.

Permission is granted to anyone to use this software for any purpose, including commercial applications, and to alter it and redistribute it freely, subject to the following restrictions:

1. Redistributions of source code must retain the above copyright notice, definition, disclaimer, and this list of conditions.
2. Redistributions in binary form (compiled executables) must reproduce the above copyright notice, definition, disclaimer, and this list of conditions in documentation and/or other materials provided with the distribution. The sole exception to this condition is redistribution of a standard UnZipSFX binary (including SFXWiz) as part of a self-extracting archive; that is permitted without inclusion of this license, as long as the normal SFX banner has not been removed from the binary or disabled.
3. Altered versions--including, but not limited to, ports to new operating systems, existing ports with new graphical interfaces, and dynamic, shared, or static library versions--must be plainly marked as such and must not be misrepresented as being the

original source. Such altered versions also must not be misrepresented as being Info-ZIP releases—including, but not limited to, labeling of the altered versions with the names “Info-ZIP” (or any variation thereof, including, but not limited to, different capitalizations), “Pocket UnZip,” “WiZ” or “MacZip” without the explicit permission of Info-ZIP. Such altered versions are further prohibited from misrepresentative use of the Zip-Bugs or Info-ZIP e-mail addresses or of the Info-ZIP URL(s).

4. Info-ZIP retains the right to use the names “Info-ZIP,” “Zip,” “UnZip,” “UnZipSFX,” “WiZ,” “Pocket UnZip,” “Pocket Zip,” and “MacZip” for its own source and binary releases.

Registered trademarks

Apple Inc.

Apple CarPlay™ is a trademark of Apple Inc.

App Store® and iTunes Store® are registered trademarks of Apple Inc.

iPhone®, iPod®, iPod touch®, iPod nano®, iPad® and Siri® are registered trademarks of Apple Inc.

Bluetooth SIG, Inc.

Bluetooth® is a registered trademark of Bluetooth SIG, Inc.

DivX, LLC

DivX® and DivX Certified® are registered trademarks of DivX, LLC.

EnGIS Technologies, Inc.

BringGo® is a registered trademark of EnGIS Technologies, Inc.

Google Inc.

Android™ and Google Play™ Store are trademarks of Google Inc.

Stitcher Inc.

Stitcher™ is a trademark of Stitcher, Inc.

Verband der Automobilindustrie e.V.

AdBlue® is a registered trademark of the VDA.

Vehicle data recording and privacy

Event data recorders

Electronic control units are installed in your vehicle. Control units process data which is received by vehicle sensors, for example, or which they generate themselves or exchange amongst themselves. Some control units are necessary for the safe functioning of your vehicle, others assist you while you drive (driver assistance systems), while others provide comfort or infotainment functions.

Operating data in the vehicle

Control units process data for operation of the vehicle.

This data includes, for example:

- Vehicle status information (e.g. wheel rotation rate, speed, movement delay, lateral acceleration, "seatbelts fastened" display),
- Ambient conditions (e.g. temperature, rain sensor, distance sensor).

Most of this data is volatile and is processed only in the vehicle itself, and not beyond the operating time.

Moreover, many control units include data storage device (amongst others the vehicle key). This is used to allow information to be documented temporarily or permanently on vehicle condition, component stress, maintenance requirements and technical events and errors.

The following information, for example, is stored:

- System component operating states (e.g. fill level, tyre pressure, battery status),
- State of charge of the high voltage battery, estimated range (in the case of electric vehicles),

- Faults and defects in important system components (e.g. lights, brakes),
- System reactions in special driving situations (e.g. triggering of an airbag, actuation of the stability control systems),
- Information on events damaging the vehicle.

In special cases (e.g. if the vehicle has detected a malfunction), it may be necessary to save data that would otherwise just be volatile.

When you use services, the operating data saved can be read together with the vehicle identification number and used if necessary. Staff working for the service net-work (e.g. garages, manufacturers) or third parties (e.g. breakdown services) can read the data from the vehicle. Services include repair services, maintenance processes, warranty cases and quality assurance measures.

Data is generally read via the OBD (On-Board Diagnostics) port prescribed by law in the vehicle. The operating data which has been read out documents the technical condition

of the vehicle or individual components and assists with fault diagnosis, compliance with warranty obligations and quality improvement. This data, in particular information on component stress, technical events, operator errors and other faults, is transmitted to the manufacturer where appropriate, together with the vehicle identification number. The manufacturer is also subject to product liability. The manufacturer potentially also needs operating data from vehicles for product recalls.

Fault memories in the vehicle can be reset by a service company when carrying out servicing or repairs.

Comfort and infotainment functions

Comfort settings and custom settings can be stored in the vehicle and changed at any time.

Depending on the equipment level in question, these include

- Seat and steering wheel position settings,
- Chassis and air conditioning settings,
- Custom settings such as interior lighting.

You can input your own data in the infotainment functions for your vehicle as part of the selected features.

Depending on the equipment level in question, these include

- Multimedia data such as music, videos or photos for playback in an integrated multimedia system,
- Address book data for use with an integrated hands-free system or an integrated navigation system,
- Input destinations,
- Data on the use of online services.

This data for comfort and infotainment functions can be stored locally in the vehicle or be kept on a

device that you have connected to the vehicle (e.g. a smartphone, USB stick or MP3 player). Data that you have input yourself can be deleted at any time.

This data can only be transmitted out of the vehicle at your request, particularly when using online services in accordance with the settings selected by you.

Smartphone integration, e.g. Android Auto or Apple CarPlay

If your vehicle is equipped accordingly, you can connect your smartphone or another mobile device to the vehicle so that you can control it via the controls integrated in the vehicle. The smartphone image and sound can be output via the multimedia system in this case. At the same time, specific information is transmitted to your smartphone. Depending on the type of integration, this includes data such as position data, day / night mode and other general vehicle information. For more

information, please see the operating instructions for the vehicle / infotainment system.

Integration allows selected smartphone apps to be used, such as navigation or music playback. No further integration is possible between smartphone and vehicle, in particular active access to vehicle data. The nature of further data processing is determined by the provider of the app used. Whether you can define settings, and if so which ones, is dependent on the app in question and your smartphone's operating system.

Online services

If your vehicle has a radio network connection, this allows data to be exchanged between your vehicle and other systems. The radio network connection is made possible by means of a transmitter device in your vehicle or a mobile device provided by you (e.g. a smartphone). Online functions can be used via this radio network connection. These include online services and applications / apps provided to you by the manufacturer or other providers.

Services of the manufacturer

In the case of the manufacturer's online services, the relevant functions are described by the manufacturer in an appropriate location (e.g. Owner's Manual, the manufacturer's website) and the associated data protection information is provided. Personal data may be used to provide online services. Data exchange for this purpose takes place via a protected connection, e.g. using the manufacturer's IT systems provided for the purpose. Collection,

processing and use of personal data for the purposes of preparation of services take place solely on the basis of legal permission, e.g. in the case of the eCall emergency communication system or a contractual agreement, or by virtue of consent.

You can activate or deactivate the services and functions (which are subject to charges to some extent) and, in some cases, the vehicle's entire radio network connection. In particular, this does not include statutory functions and services such as eCall.

Third party services

If you make use of online services from other providers (third parties), these services are subject to the liability and data protection and usage conditions of the provider in question. The manufacturer frequently has no influence over the content exchanged in this regard.

Therefore, please note the nature, scope and purpose of the collection and use of personal data within the scope of third party services provided by the service provider in question.

Radio Frequency Identification (RFID)

RFID technology is used in some vehicles for functions such as tyre pressure monitoring and ignition system security. It is also used in connection with conveniences such as radio remote controls for door locking/unlocking and starting, and in-vehicle transmitters for garage door openers. RFID technology in Opel vehicles does not use or record personal information or link with any other Opel system containing personal information.

Index

- A**
- Accessories and vehicle modifications 191
 - Active head restraints..... 48
 - Adaptive forward lighting 96, 118, 200
 - AdBlue..... 94, 145
 - Adjustable air vents 135
 - Airbag, belt tensioners and roll bars..... 91
 - Airbag deactivation 63, 91
 - Airbag label..... 59
 - Airbag system 59
 - Air conditioning regular operation 136
 - Air conditioning system 128
 - Air intake 135
 - Air vents..... 135
 - Antilock brake system 152
 - Antilock brake system (ABS) 93
 - Anti-theft alarm system 28
 - Anti-theft locking system 27
 - Appearance care..... 232
 - Armrest..... 55
 - Armrest storage 72
 - Ashtrays 84
 - Automatic anti-dazzle 32
 - Automatic light control 115
 - Automatic locking 25
 - Automatic transmission 148
- B**
- Autostop..... 140
 - Auxiliary heater..... 134
- B**
- Battery discharge protection 126
 - Battery voltage 104
 - BlueInjection..... 145
 - Bonnet 192
 - Brake and clutch fluid..... 236
 - Brake and clutch system 92
 - Brake assist 155
 - Brake fluid 196
 - Brakes 152, 195
 - Breakdown..... 230
 - Bulb replacement 198
- C**
- Capacities 247
 - Car Pass 22
 - Catalytic converter 145
 - Central locking system 23
 - Centre console storage 72
 - Changing tyre and wheel size ... 218
 - Charging system 91
 - Child restraint installation locations 67
 - Child restraints..... 65
 - Child restraint systems 65
 - Cigarette lighter 84
 - Climate control 16
 - Climate control systems..... 127

Clock.....	82
Code.....	103
Control indicators.....	88
Control of the vehicle	138
Controls.....	79
Convex shape	30
Coolant and antifreeze.....	236
Cruise control	96, 159
Cupholders	71
Curve lighting.....	118

D

Danger, Warnings and Cautions ...	4
Daytime running lights	118
Declaration of conformity.....	250
DEF.....	145
Diesel exhaust fluid.....	145
Diesel fuel system bleeding	197
Door open	96
Doors.....	26
Driver assistance systems.....	159
Driver Information Centre.....	96
Driving characteristics and towing tips	185
Driving hints.....	138

E

Electric adjustment	30
Electrical system.....	206
Electric parking brake.....	92, 153
Electric parking brake fault.....	93

Electronic climate control system	130
Electronic driving programmes ..	150
Electronic Stability Control.....	156
Electronic Stability Control and Traction Control system.....	94
Electronic Stability Control off.....	94
End-of-life vehicle recovery	192
Engine compartment fuse box ..	207
Engine coolant	194
Engine coolant temperature gauge	86
Engine data	244
Engine exhaust	144
Engine identification.....	240
Engine oil	193, 236, 241
Engine oil pressure	95
Entry lighting	125
Event data recorders.....	256
Exhaust filter.....	94, 144
Exit lighting	125
Exterior care	232
Exterior light	95
Exterior lighting	14, 114
Exterior mirrors.....	30

F

Fault	151
First aid.....	76
First aid kit	76
Fixed air vents	135

Fog light	96
Fog lights	201
Folding mirrors	31
Following distance indication.....	164
Forward collision alert.....	162
Front airbag system	62
Front fog lights	122
Front seats.....	49
Front storage.....	71
Front turn lights	202
Fuel.....	180
Fuel for diesel engines	182
Fuel for petrol engines	180
Fuel gauge	86
Funnel.....	182
Fuses	206

G

Gauges.....	85
General information	185
Glovebox	70
Ground clearance.....	138

H

Halogen headlights	198
Hand brake.....	152, 153
Hazard warning flashers	121
Headlight flash	117
Headlight range adjustment	117
Headlights.....	114
Headlights when driving abroad	117

Head restraint adjustment	8
Head restraints	47
Heated mirrors	31
Heated rear window	35
Heated steering wheel	79
Heating	55
Heating and ventilation system .	127
High beam	95, 116
High beam assist.....	96, 116
Hill start assist	155
Horn	15, 80

I

Identification plate	239
Ignition switch positions	139
Immobiliser	30, 95
Indicators.....	85
Info Display.....	101
Information displays.....	96
Instrument cluster	85
Instrument panel fuse box	209
Instrument panel illumination	206
Instrument panel illumination control	123
Instrument panel overview	10
Interactive driving system.....	157
Interior care	234
Interior lighting.....	123
Interior lights	124, 206
Interior mirrors.....	32

Interruption of power supply	151
Introduction	3

J

Jump starting	228
---------------------	-----

K

Key, memorised settings.....	23
Keys	21
Keys, locks.....	21

L

Lane departure warning.....	93, 179
Lashing eyes	76
Light switch	114
Load compartment	26, 73
Load compartment fuse box	210
Loading information	77
Low fuel	95

M

Malfunction indicator light	92
Manual anti-dazzle	32
Manual mode	150
Manual seat adjustment.....	50
Manual transmission	152
Memorised settings.....	23
Mirror adjustment	8
Misted light covers	123

N

New vehicle running-in	139
Number plate light	205

O

Object detection systems.....	165
Odometer	85
Oil, engine.....	236, 241
OnStar.....	109
Operate pedal.....	92
Outside temperature	81
Overrun cut-off	140

P

Parking	19, 142
Parking assist	165
Parking brake	153
Parking lights	123
Particulate filter.....	144
Performance	245
Performing work	192
Pollen filter	135
Power outlets	83
Power seat adjustment	53
Power steering.....	93
Power windows	33
Preheating	94
Puncture.....	222

Q

Quickheat.....	134
----------------	-----

- R**
- Radio Frequency Identification (RFID)..... 259
 - Radio remote control 22
 - REACH..... 254
 - Reading lights 124
 - Rear floor storage cover 75
 - Rear fog light 96
 - Rear fog lights 122
 - Rear storage..... 75
 - Rear view camera 174
 - Recommended fluids and lubricants 236, 241
 - Refuelling 182
 - Registered trademarks..... 256
 - Retained power off..... 139
 - Reversing lights 123
 - Ride control systems..... 155
 - Rollover protection system..... 45
- S**
- Seat adjustment 7
 - Seat belt 8
 - Seat belt reminder 91
 - Seat belts 56
 - Seat folding 52
 - Seat heating..... 55
 - Seat position 49
 - Seat ventilation..... 55
 - Selective catalytic reduction..... 145
 - Selector lever 149
 - Service 136, 235
 - Service display 87
 - Service information 235
 - Side airbag system 63
 - Side blind spot alert..... 172
 - Sidelights..... 114
 - Side turn lights 204
 - Soft top 36
 - Software acknowledgement..... 254
 - Spare wheel 225
 - Speed limiter..... 161
 - Speedometer 85
 - Starting and operating..... 139
 - Starting off 18
 - Starting the engine 139
 - Steering..... 138
 - Steering wheel adjustment 9, 79
 - Steering wheel controls 79
 - Stop-start system..... 140
 - Storage..... 70
 - Storage compartments..... 70
 - Sunvisor lights 124
 - Sun visors 35
 - Symbols 4
- T**
- Tachometer 86
 - Tail lights 203
 - Three-point seat belt 57
 - Tools 212
 - Tow bar..... 185
 - Towing..... 185, 230
 - Towing another vehicle 231
 - Towing equipment 186
 - Towing the vehicle 230
 - Traction Control system 155
 - Traction Control system off..... 94
 - Traffic sign assistant..... 176
 - Trailer coupling..... 185
 - Trailer towing 185
 - Transmission 17
 - Transmission display 148
 - Tread depth 218
 - Trip odometer 85
 - Turn lights 90, 122
 - Tyre chains 219
 - Tyre designations 213
 - Tyre pressure 217
 - Tyre pressure monitoring system..... 94, 213
 - Tyre pressures 248
 - Tyre repair kit 219
- U**
- Ultrasonic parking assist..... 165
 - Upholstery..... 234
 - Upshift..... 93
 - Using this manual 3

V

Vehicle battery	196
Vehicle checks.....	192
Vehicle data.....	241
Vehicle data recording and privacy.....	256
Vehicle detected ahead.....	96
Vehicle dimensions	246
Vehicle Identification Number ...	239
Vehicle jack.....	212
Vehicle messages	103
Vehicle personalisation	104
Vehicle security.....	27
Vehicle specific data	3
Vehicle storage.....	191
Vehicle tools.....	212
Vehicle unlocking	6
Vehicle weight	245
Ventilating.....	55
Ventilation.....	127

W

Warning chimes	103
Warning lights.....	85
Warning triangle	76
Washer and wiper systems	16
Washer fluid	195
Wheel changing	222
Wheel covers	219
Wheels and tyres	213

Wind deflector.....	43
Windows.....	32
Windscreen.....	32
Windscreen wiper and washer ...	80
Winter tyres	213
Wiper blade replacement	198

www.opel.com

Copyright by Opel Automobile GmbH, Rüsselsheim, Germany.

The information contained in this publication is effective as of the date indicated below. Opel Automobile GmbH reserves the right to make changes to the technical specifications, features and design of the vehicles relative to the information in this publication as well as changes to the publication itself.

Edition: January 2018, Opel Automobile GmbH, Rüsselsheim.

Printed on chlorine-free bleached paper.

ID-OCAA0BSE1801-en

