

ANTARA

Owner's Manual



Contents

Introduction	2
In brief	6
Keys, doors and windows	20
Seats, restraints	35
Storage	56
Instruments and controls	71
Lighting	105
Climate control	114
Driving and operating	122
Vehicle care	156
Service and maintenance	201
Technical data	204
Customer information	213
Index	218

Introduction

Fuel	Designation	<input type="text"/>		
Engine oil	Grade	<input type="text"/>		
	Viscosity	<input type="text"/>		
Tyre pressure	Tyre size		Front	Rear
	Summer tyres	<input type="text"/>	<input type="text"/>	<input type="text"/>
	Winter tyres	<input type="text"/>	<input type="text"/>	<input type="text"/>
Weights	Gross vehicle weight rating	<input type="text"/>		
	- Kerb weight, basic model	<input type="text"/>		
	= Loading	<input type="text"/>		

Vehicle specific data

Please enter your vehicle's data on the previous page to keep it easily accessible. This information is available in the sections "Service and maintenance" and "Technical data" as well as on the identification plate.

Introduction

Your vehicle is a designed combination of advanced technology, safety, environmental friendliness and economy.

This Owner's Manual provides you with all the necessary information to enable you to drive your vehicle safely and efficiently.

Make sure your passengers are aware of the possible risk of accident and injury which may result from improper use of the vehicle.

You must always comply with the specific laws and regulations of the country that you are in. These laws may differ from the information in this Owner's Manual.

Disregarding the description given in this manual may affect your warranty.

When this Owner's Manual refers to a workshop visit, we recommend your Opel Service Partner.

All Opel Service Partners provide first-class service at reasonable prices. Experienced mechanics trained by Opel work according to specific Opel instructions.

The customer literature pack should always be kept ready to hand in the vehicle.

Using this manual

- This manual describes all options and features available for this model. **Certain descriptions, including those for display and menu functions, may not apply to your vehicle due to model variant, country specifications, special equipment or accessories.**
- The "In brief" section will give you an initial overview.
- The table of contents at the beginning of this manual and within each section shows where the information is located.

- The index will enable you to search for specific information.
- This Owner's Manual depicts left-hand drive vehicles. Operation is similar for right-hand drive vehicles.
- The Owner's Manual uses the engine identifier code. The corresponding sales designation and engineering code can be found in the section "Technical data".
- Directional data, e.g. left or right, or front or back, always relate to the direction of travel.
- Displays may not support your specific language.
- Display messages and interior labelling are written in **bold** letters.

Danger, Warnings and Cautions

Danger

Text marked ** Danger** provides information on risk of fatal injury. Disregarding this information may endanger life.

Warning

Text marked ** Warning** provides information on risk of accident or injury. Disregarding this information may lead to injury.

Caution

Text marked **Caution** provides information on possible damage to the vehicle. Disregarding this information may lead to vehicle damage.

Symbols

Page references are indicated with ⇨.
⇨ means "see page".

Page references and index entries refer to the indented headings given in the section table of content.

We wish you many hours of pleasurable driving.

Adam Opel AG

In brief

Initial drive information

Vehicle unlocking

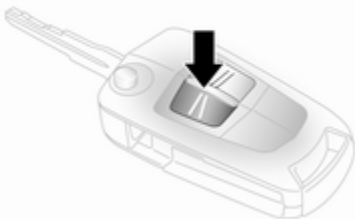

Press  to unlock the doors and load compartment. Open the doors by pulling the handles. To open the tailgate, operate button above number plate.

Radio remote control ⇨ 21, Central locking system ⇨ 22, Load compartment ⇨ 24.

Seat adjustment

Longitudinal adjustment



Pull handle, slide seat, release handle.

Seat position ⇨ 36, Seat adjustment ⇨ 37.

 **Danger**

Do not sit nearer than 25 cm from the steering wheel, to permit safe airbag deployment.

Backrests inclination



Pull lever, adjust inclination and release lever. Allow the backrest to engage audibly. Do not lean on the seat backrest whilst adjusting it.

Seat position ⇨ 36, Seat adjustment ⇨ 37, Seat folding ⇨ 38.

Seat height

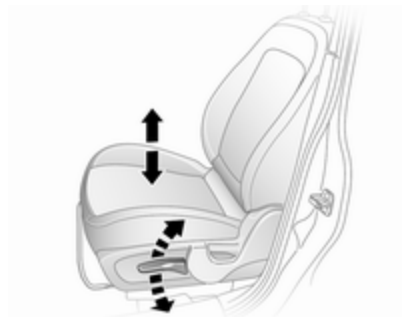

Lever pumping motion

up : seat higher
down : seat lower

Seat position ⇨ 36, Seat adjustment ⇨ 37.

Power seat adjustment

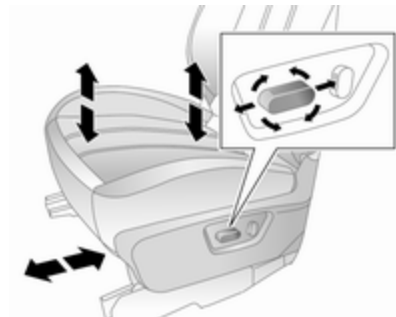

Operate switches.

Positioning	: move front switch forwards/ backwards
Height of front part of seat	: move front part of front switch upwards/ downwards
Height of rear part of seat	: move rear part of front switch upwards/ downwards

Height of entire seat : move entire front switch upwards/ downwards

Backrest : move upper part of rear switch forwards/ backwards

Seat position ⇨ 36, Power seat adjustment ⇨ 39.

Head restraint adjustment

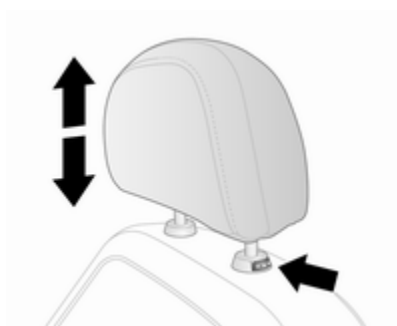

Press release button, adjust height and engage.

Head restraints ⇨ 35.

Seat belt



Pull out the seat belt and engage in belt buckle. The seat belt must not be twisted and must fit close against the body. The backrest must not be tilted back too far (maximum approx. 25 °).

To release belt, press red button on belt buckle.

Seat position ⇨ 36, Seat belts ⇨ 41, Airbag system ⇨ 45.

Mirror adjustment

Interior mirror

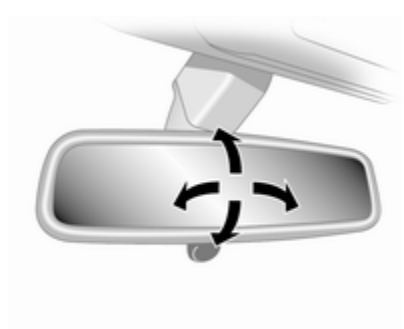

To adjust the mirror, move the mirror housing in the desired direction.
Interior mirror ⇨ 30, Automatic anti-dazzle interior mirror ⇨ 30.

Exterior mirrors

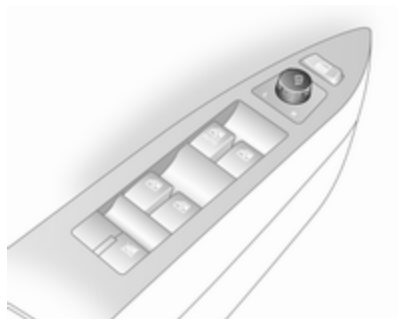

Select the relevant exterior mirror and adjust it.

Convex exterior mirrors ⇨ 28,
Electric adjustment ⇨ 28, Folding exterior mirrors ⇨ 29, Heated exterior mirrors ⇨ 29.

Steering wheel adjustment

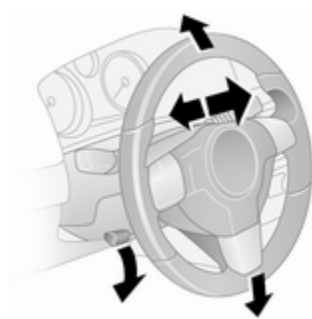

Unlock lever, adjust steering wheel, then engage lever and ensure it is fully locked.

Do not adjust steering wheel unless vehicle is stationary and steering wheel lock has been released.

Airbag system ⇨ 45, Ignition positions ⇨ 125.

Instrument panel overview

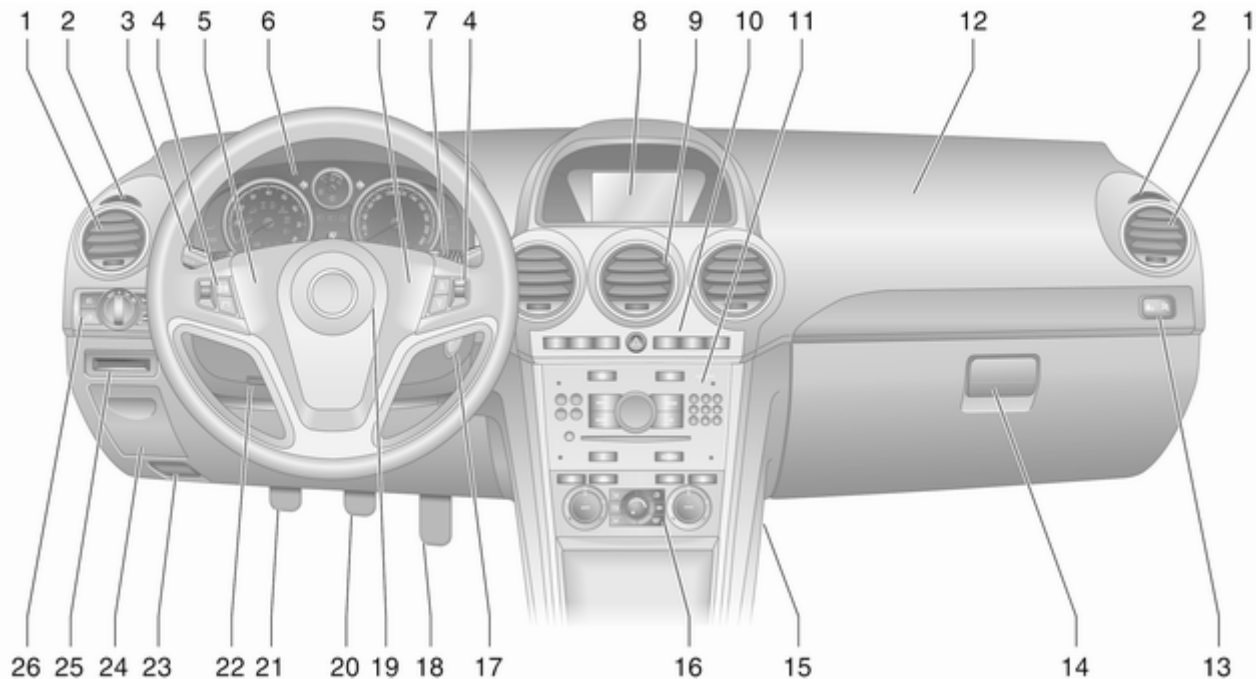

<p>1 Side air vents 119</p> <p>2 Fixed air vents 120</p> <p>3 High beam 106</p> <p style="padding-left: 20px;">Headlight flash 106</p> <p style="padding-left: 20px;">Turn and lane-change signals 108</p> <p style="padding-left: 20px;">Exit lighting 112</p> <p style="padding-left: 20px;">Parking lights 109</p> <p style="padding-left: 20px;">Cruise control 91</p> <p>4 Remote control on steering wheel 72</p> <p style="padding-left: 20px;">Trip computer 100</p> <p>5 Horn 72</p> <p>6 Instruments 78</p> <p style="padding-left: 20px;">Driver Information Centre 91</p> <p>7 Windscreen wiper and washer system, headlight washer system 73</p> <p style="padding-left: 20px;">Rear window wiper and washer system 74</p>	<p>8 Info-Display 94</p> <p style="padding-left: 20px;">Check control, tyre pressure monitoring system 183</p> <p style="padding-left: 20px;">Trip computer 100</p> <p>9 Centre air vents 119</p> <p>10 Hazard warning flashers 107</p> <p style="padding-left: 20px;">Parking assist 148</p> <p style="padding-left: 20px;">Electronic Stability Control . 145</p> <p style="padding-left: 20px;">Descent control system 146</p> <p style="padding-left: 20px;">Status LED for anti-theft alarm system 26</p> <p style="padding-left: 20px;">Folding exterior mirrors 29</p> <p style="padding-left: 20px;">Fuel economy mode 122</p> <p>11 Infotainment system 10</p> <p>12 Front passenger airbag 48</p> <p>13 Status LEDs for front passenger airbag 50</p> <p style="padding-left: 20px;">Control indicator for front passenger seat belt 42</p> <p>14 Glovebox 57</p> <p>15 Fuse box 176</p>	<p>16 Climate control system 114</p> <p>17 Ignition switch with steering wheel lock 125</p> <p>18 Accelerator pedal 124</p> <p>19 Driver airbag 48</p> <p>20 Brake pedal 142</p> <p>21 Clutch pedal 123</p> <p>22 Steering wheel adjustment . . 72</p> <p>23 Bonnet release 158</p> <p>24 Coin storage 56</p> <p>25 Card holder 56</p> <p>26 Light switch 105</p> <p style="padding-left: 20px;">Automatic light control 106</p> <p style="padding-left: 20px;">Instrument illumination 110</p> <p style="padding-left: 20px;">Rear fog light 109</p> <p style="padding-left: 20px;">Front fog lights 108</p> <p style="padding-left: 20px;">Headlight range adjustment 106</p>
--	---	--

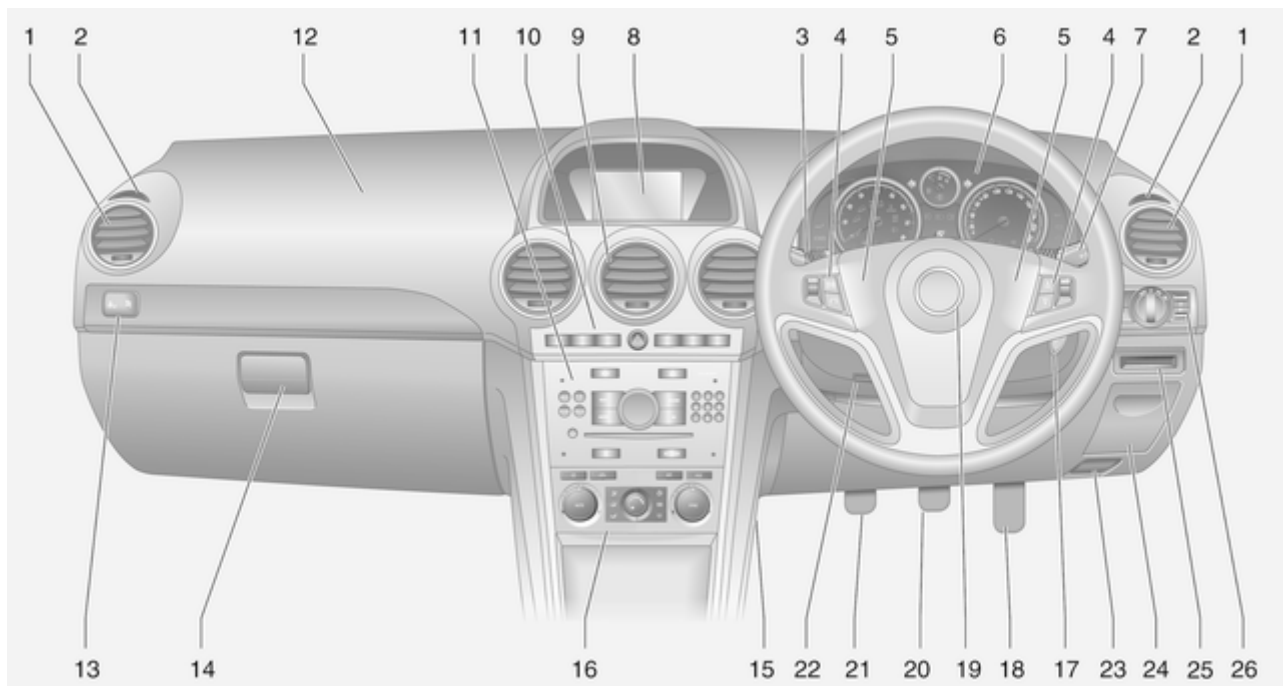

Exterior lighting



Turn light switch:

AUTO : Automatic light control:
Headlights are switched on and off automatically depending on external lighting conditions.

O : Off (or deactivation of automatic light control)

☞☞ : Sidelights

☞D : Headlights

Press button:

☞D : Front fog lights

☞☞ : Rear fog light

Lighting ⇨ 105.

Headlight flash, high beam and low beam

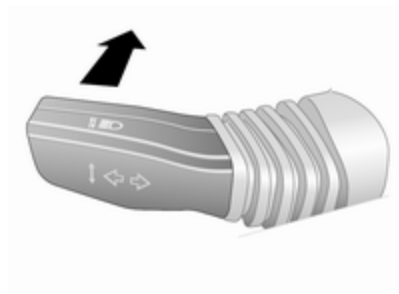

headlight : pull lever

flash

high beam : push lever

low beam : pull lever back towards steering wheel

Automatic light control ⇨ 106, High beam ⇨ 106, Headlight flash ⇨ 106.

Turn and lane-change signals





right : lever up

left : lever down

Turn and lane-change signals
⇨ 108, Parking lights ⇨ 109.

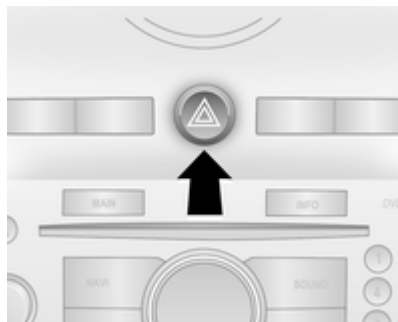
Hazard warning flashers



Operated by pressing .
Hazard warning flashers ⇨ 107.

Horn



Press .

Washer and wiper systems

Windscreen wiper

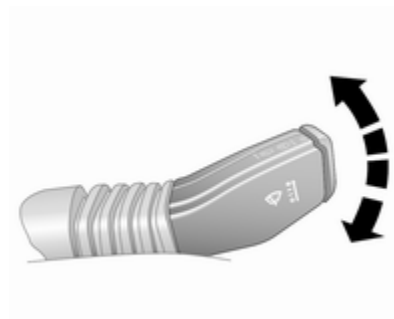

- ≡ : fast
- : slow
- : timed interval wiping or automatic wiping with rain sensor
- : off

For a single wipe when the windscreen wiper is off, press the lever down.

Windscreen wiper ⇨ 73, Wiper blade replacement ⇨ 165.

Windscreen and headlight washer systems

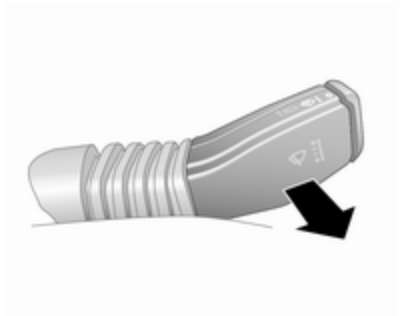

Pull lever.

Windscreen and headlight washer system ↻ 73, Washer fluid ↻ 161.

Rear window wiper and washer system

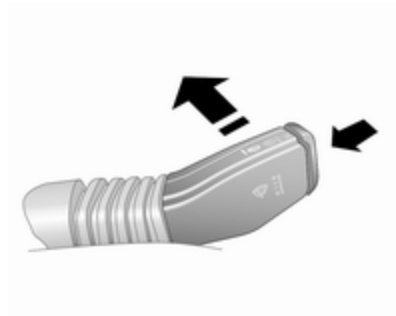

Wiper on : push lever

Wiper off : pull lever

Wash : press and hold button

Rear window wiper and washer system ↻ 74, Wiper blade replacement ↻ 165, Washer fluid ↻ 161.

Climate control

Heated rear window, heated exterior mirrors



Heating is operated by pressing .

Heated rear window ↻ 32, Heated exterior mirrors ↻ 29.

Demisting and defrosting the windows



Air distribution to (or).

Cooling **A/C** (or) and air recirculation are switched on automatically to improve defrosting efficiency (air recirculation is automatically switched off in vehicles with electronic climate control).

Set temperature to highest level.

Set fan speed to highest level.

Switch on heated rear window .

Close centre air vents, open side air vents and direct them towards the door windows.

Climate control system ⇨ 114.

Transmission

Manual transmission



Reverse: with the vehicle stationary, wait 3 seconds after depressing clutch pedal and engage the gear.

If the gear does not engage, set the lever to neutral, release the clutch pedal and depress again; then repeat gear selection.

Manual transmission ⇨ 139.

Automatic transmission



P : park
R : reverse
N : neutral
D : drive

Manual mode: move selector lever from **D** to the left.

+ : higher gear
- : lower gear

The selector lever can only be moved out of **P** when the ignition is on and the foot brake is applied. To engage **P** or **R**, push the release button.

Automatic transmission ⇨ 136.

Starting off

Check before starting off

- Tyre pressure and condition
⇨ 182, ⇨ 212.
- Engine oil level and fluid levels
⇨ 159.
- All windows, mirrors, exterior lighting and number plates are free from dirt, snow and ice and are operational.
- Proper position of mirrors, seats, and seat belts ⇨ 28, ⇨ 36, ⇨ 42.
- Brake function at low speed, particularly if the brakes are wet.

Starting the engine



- Turn key to position **ACC**
 - move the steering wheel slightly to release the steering wheel lock
 - manual transmission in neutral
 - operate clutch and brake pedals
 - automatic transmission in **P** or **N**
 - do not accelerate
 - diesel engines: turn key to **ON** for preheating and wait until control indicator  extinguishes
 - turn key to **START** and release
- Starting the engine ⇨ 125.

Stop-start system



If the vehicle is at a low speed or at a standstill and certain conditions are fulfilled, activate an Autostop as follows:

- Depress the clutch pedal
- shift the selector lever to **N**
- release the clutch pedal

An Autostop is indicated by the needle at the **AUTOSTOP** position in the tachometer.

To restart the engine, depress the clutch pedal again.

Stop-start system ↪ 126.

Parking

⚠ Warning

- Do not park the vehicle on an easily ignitable surface. The high temperature of the exhaust system could ignite the surface.
- Always apply the electrical parking brake.

Pull switch (Ⓢ).

The electric parking brake is applied when control indicator (Ⓢ) illuminates ↪ 85.

For maximum force, e.g. parking with a trailer or on inclines, pull switch (Ⓢ) twice.

- Switch off the engine.
- If the vehicle is on a level surface or uphill slope, engage first gear or move the selector lever to **P** before removing the ignition key. On an uphill slope, turn the front wheels away from the kerb.

If the vehicle is on a downhill slope, engage reverse gear or move the selector lever to **P** before removing the ignition key. Turn the front wheels towards the kerb.

- Close windows and sunroof.
- Turn the ignition key to position **LOCK**, push key into ignition switch and remove.

For vehicles with automatic transmission, depress foot brake and shift into **P** before pushing key into ignition switch and removing.

Turn the steering wheel until the steering wheel lock is felt to engage.

- Lock the vehicle with **Ⓢ** on the radio remote control ↪ 22.
- Activate the anti-theft alarm system ↪ 26.

- The engine cooling fans may run after the engine has been switched off ⇨ 158.
- After running at high engine speeds or with high engine loads, operate the engine briefly at a low load or run in neutral for approx. 1 or 2 minutes, before switching off in order to protect the turbocharger.

Keys, locks ⇨ 20, Laying the vehicle up for a long period of time ⇨ 157.

Keys, doors and windows

Keys, locks	20
Keys	20
Car Pass	21
Radio remote control	21
Central locking system	22
Child locks	23
Doors	24
Load compartment	24
Vehicle security	25
Anti-theft locking system	25
Anti-theft alarm system	26
Immobiliser	28
Exterior mirrors	28
Convex shape	28
Electric adjustment	28
Folding mirrors	29
Heated mirrors	29
Automatic dimming	30
Interior mirrors	30
Manual anti-dazzle	30
Automatic anti-dazzle	30
Windows	31
Windscreen	31

Power windows	31
Heated rear window	32
Sun visors	33
Roof	33
Sunroof	33

Keys, locks

Keys

Replacement keys

The key number is specified in the Car Pass or on a detachable tag.

The key number must be quoted when ordering replacement keys as it is a component of the immobiliser system.

Locks ⇨ 198.

Key with foldaway key section

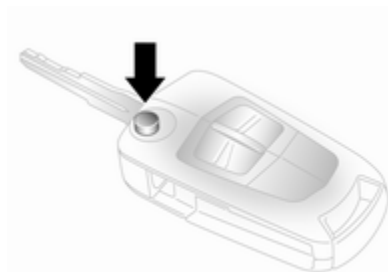

Press button to extend. To fold the key, first press the button.

Car Pass

The Car Pass contains security related vehicle data and should therefore be kept in a safe place.

When the vehicle is taken to a workshop, this vehicle data is needed in order to perform certain operations.

Radio remote control

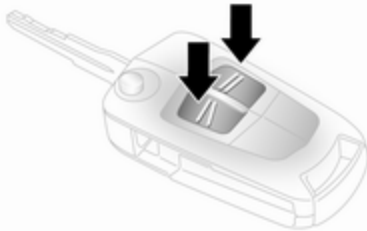

Used to operate:

- Central locking system
- Anti-theft locking system
- Anti-theft alarm system

The radio remote control has a range of approx. 6 metres. This range can be affected by external influences. The hazard warning flashers confirm operation.

Handle with care, protect from moisture and high temperatures and avoid unnecessary operation.

Fault

If the central locking system cannot be operated with the radio remote control, it may be due to the following:

- Range exceeded.
- Battery voltage too low.
- Frequent, repeated operation of the radio remote control while not in range, which will require reprogramming. Seek the assistance of a workshop.
- Overload of the central locking system by operating at frequent intervals, the power supply is interrupted for a short time.
- Interference from higher-power radio waves from other sources.

Unlocking ⇨ 22.

Radio remote control battery replacement

Replace the battery as soon as the range reduces.



Batteries do not belong in household waste. They must be disposed of at an appropriate recycling collection point.

Key with foldaway key section

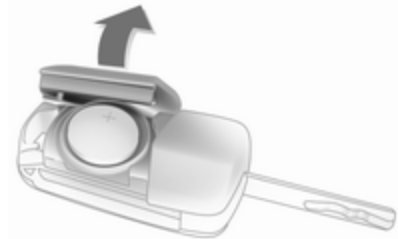

Extend the key and open the unit. Replace the battery (battery type CR2032), paying attention to the installation position. Close the unit.

Key with fixed key section

Open the unit with a small screwdriver in the notch on the cover. Replace the battery (battery type CR2032), paying attention to the installation position. Close the unit.

Central locking system

Unlocks and locks doors, load compartment and fuel filler flap.

A pull on an interior door handle unlocks the respective door. Pulling the handle once more opens the door.

Note

In the event of an accident in which airbags or belt pretensioners are deployed, the vehicle is automatically unlocked.

Unlocking

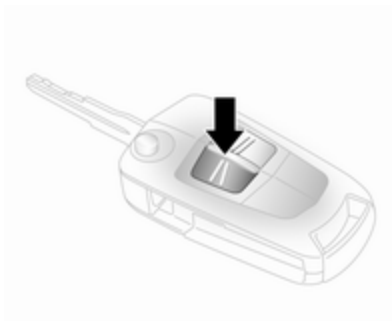

Press \supseteq .

Note

If no door is opened within 5 minutes after the vehicle has been unlocked, the vehicle is relocked automatically (and the anti-theft alarm is reactivated).

When \supseteq is pressed, the instrument panel illuminates for approx. 30 seconds or until ignition switch is turned to position **ACC**.

Locking

Close doors, load compartment, fuel filler flap, bonnet, windows and sunroof.

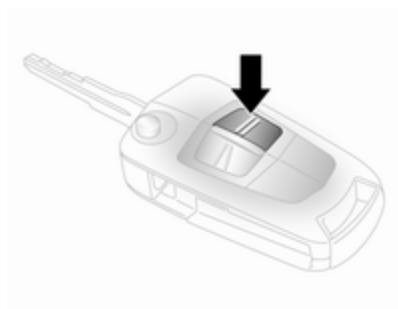

Press \supseteq .

The central locking system can be activated with the windows open.

Note

For safety reasons, the vehicle cannot be locked or unlocked via the remote control (and the anti-theft systems will not be activated) if the key is in the ignition switch.

If the driver's door is not closed properly, the central locking system will not work.

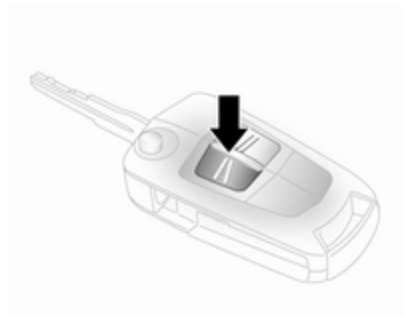
Unlocking the tailgate

Press .

The tailgate is unlocked together with the doors.

With the engine running, the tailgate will only unlock when the electrical parking brake is applied or automatic transmission is in position **P**.

Central locking buttons

Locks or unlocks all doors, the load compartment and fuel filler flap from the passenger compartment.

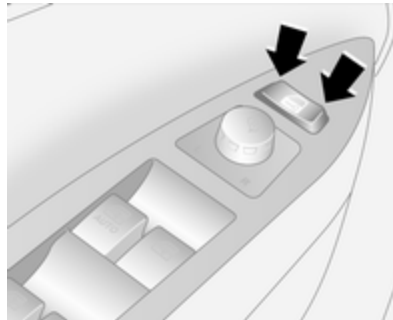

Press left part of  to lock.

Press right part of  to unlock.

When the key is in the ignition switch, locking is only possible if all doors are closed.

Fault in radio remote control system**Unlocking**

Manually unlock the driver's door by turning the key in the lock. Switch on the ignition and press the left part of central locking switch  to unlock all doors, load compartment and fuel filler flap.

Locking

Manually lock the driver's door by turning the key in the lock.

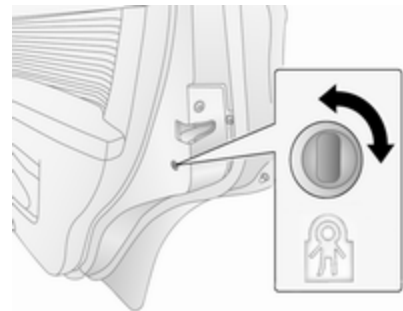
Child locks

⚠ Warning

Use the child locks whenever children are occupying the rear seats.

Using a key or suitable screwdriver, turn button on rear door lock to the horizontal position. The door cannot be opened from inside.

For deactivation, turn the child lock to the vertical position.

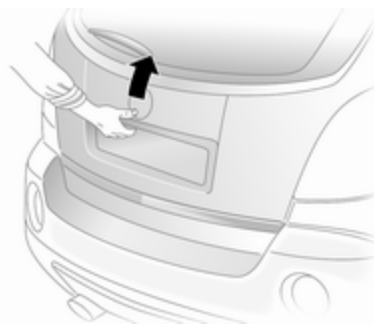
Doors**Load compartment****Tailgate****Opening**

Operate the button above the number plate and lift the tailgate.

Central locking system ⇨ 22.

Closing

Use the interior handle.

Do not operate the button above the number plate while closing the tailgate, as this will unlock it again.

Central locking system ⇨ 22.

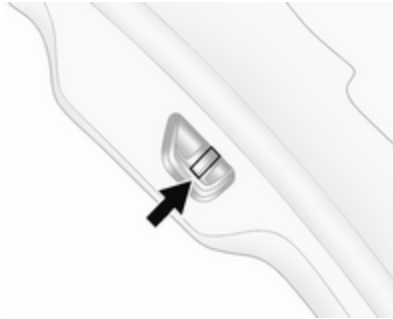
Fault

To open the tailgate in the event of power interruption:

Remove the interior trim cover from the central latch area, then push the lever using a suitable tool.

General hints for operating tailgate**⚠ Warning**

Do not drive with the tailgate open or ajar, e.g. when transporting bulky objects, since toxic exhaust gases, which cannot be seen or

smelled, could enter the vehicle. This can cause unconsciousness and even death.

Caution

Before opening the tailgate check overhead obstructions, such as a garage door, to avoid damage to the tailgate. Always check the moving area above and behind the tailgate.

Note

The installation of certain heavy accessories onto the tailgate may affect its ability to remain open.

Vehicle security**Anti-theft locking system****⚠ Warning**

Do not use the system if there are people in the vehicle! The doors cannot be unlocked from the inside.

The system deadlocks all the doors. All doors must be closed otherwise the system cannot be activated.

If the ignition was on, the driver's door must be opened and closed once so that the vehicle can be secured.

Unlocking the vehicle disables the mechanical anti-theft locking system. This is not possible with the central locking button.

Activating

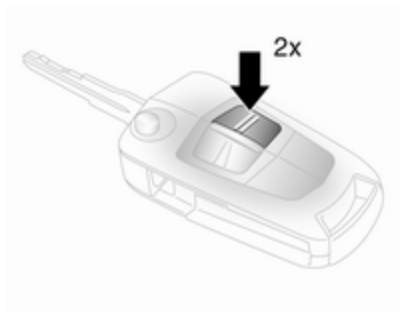

Press **=** on the radio remote control twice within 3 seconds.

Alternatively, turn key in driver's door towards rear of vehicle again within 3 seconds after locking.

Anti-theft alarm system

The anti-theft alarm system is combined with the anti-theft locking system.

It monitors:

- Doors, tailgate, bonnet
- Passenger compartment including adjoining load compartment
- Vehicle inclination, e.g. if it is raised
- Siren power supply
- Ignition

Unlocking the vehicle deactivates both systems simultaneously.

Activation

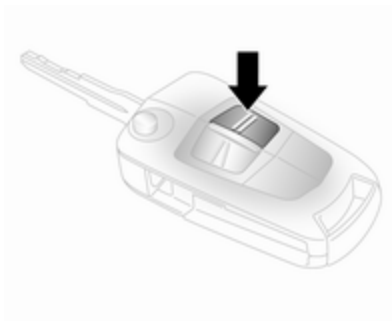

Ensure the doors, tailgate, fuel filler flap, bonnet, windows and sunroof are closed.

Press **=** on radio remote control or manually lock the driver's door.

The system is activated:

- Automatically, 30 seconds after locking the vehicle (initialisation of the system)
- Directly by pressing **=** on the radio remote control once more after locking

If the hazard warning lights do not flash once upon activation or the control indicator flashes rapidly, this may indicate that a door, the tailgate or the bonnet is not fully closed.



Note

Changes to the vehicle interior such as the use of seat covers, and open windows or sunroof, could impair the function of passenger compartment monitoring.

Activation without monitoring of passenger compartment and vehicle inclination





Switch off the monitoring of passenger compartment and vehicle inclination when people or animals are being left in the vehicle, because of high volume ultrasonic signals, movements triggering the alarm and when the vehicle is on a ferry or train.

1. Close tailgate, bonnet, windows and sunroof.
2. Press . Control indicator  illuminates yellow in the instrument cluster.

3. Close doors.

4. Activate the anti-theft alarm system.

Press  again to cancel. Control indicator  extinguishes.

Status LED



Status LED is located in the centre console.

Status during the first 30 seconds of anti-theft alarm system activation:

LED illuminates : test, arming delay.
 LED flashes : doors, tailgate or bonnet not completely closed, or system fault.

Status after system is armed:

LED flashes : system is armed.
 slowly
 LED flashes : system is
 quickly 3 times : disarmed.
 after unlocking

Seek the assistance of a workshop in the event of faults.

Deactivation

Unlocking the vehicle deactivates anti-theft alarm system. Hazard warning lights flash twice upon deactivation.

If no door is opened or the engine is not started within 5 minutes after the vehicle has been unlocked, the vehicle is relocked automatically and the alarm is reactivated.

If the alarm has been triggered, the hazard warning lights will not flash upon deactivation.

Alarm

When triggered, the alarm sounds via a separate battery-backed power sounder, and the hazard warning

lights flash simultaneously. The number and duration of alarm signals are stipulated by legislation.



The alarm can be silenced by pressing any button of the radio remote control or manually unlocking the driver's door with the ignition key. The anti-theft alarm system is deactivated at the same time.

Immobiliser



The system is part of the ignition switch and checks whether the vehicle is allowed to be started with the key being used.

The immobiliser is activated automatically after the key has been removed from the ignition switch.

Control indicator  illuminates in the instrument cluster when the ignition is switched on, then extinguishes. If  remains illuminated when the ignition is on, there is a fault in the system; the engine cannot be started. Switch off the ignition and remove key, wait approx. 2 seconds and then repeat the start attempt.

If the control indicator remains illuminated, attempt to start the engine using the spare key and seek the assistance of a workshop.

Note

The immobiliser does not lock the doors. You should always lock the vehicle after leaving it and switch on the anti-theft alarm system ↗ 22, ↗ 26.

Control indicator  ↗ 90.

Exterior mirrors

Convex shape

The convex exterior mirror contains an aspherical area and reduces blind spots. The shape of the mirror makes objects appear smaller, which will affect the ability to estimate distances.

Electric adjustment

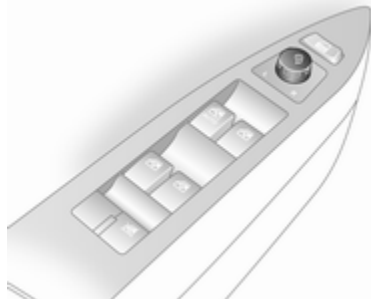

Select the relevant exterior mirror by turning the switch to left (L) or right (R). Then swivel the control to adjust the mirror.

Folding mirrors

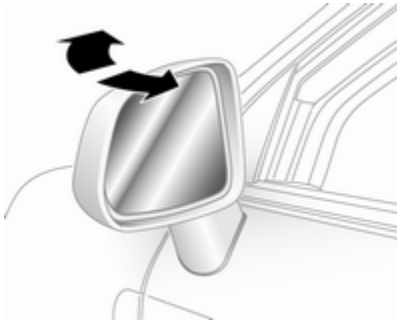



For pedestrian safety, the exterior mirrors will swing out of their normal mounting position if they are struck with sufficient force. Reposition the mirror by applying slight pressure to the mirror housing.

Manual folding

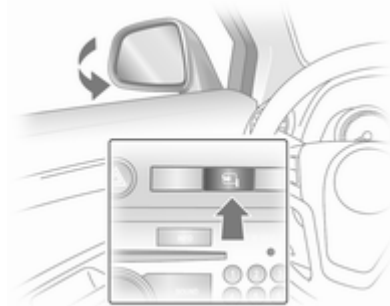

Press lightly on the outside of the mirror housing to fold in the exterior mirrors.

Electric folding



With ignition switch in positions **ACC** or **ON**, press  and both exterior mirrors will fold in.

Press  again - both exterior mirrors return to their original position.

If an electrically folded mirror is manually extended, pressing  will only electrically extend the other mirror. Pressing  again folds both mirrors back in.

Fold mirrors back to the driving position before driving the vehicle.

Heated mirrors



Operated by pressing . LED illuminates in the button.

Heating works with the key in ignition switch positions **ACC** or **ON** and is switched off automatically after a short time.

To avoid discharging the battery, operate only with the engine running. Do not operate when you are just starting the vehicle, or if there is a build up of snow or ice on the exterior mirrors.

Do not use sharp instruments or abrasive cleaners on the exterior mirrors and avoid scratching or damaging the heating elements.

Automatic dimming

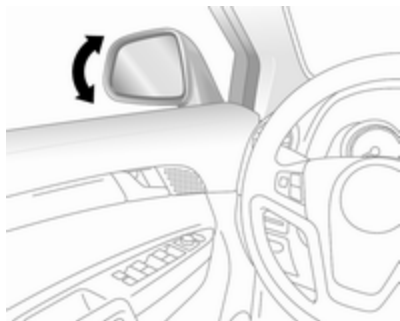

Exterior mirror on the driver's side dims to reduce glare automatically in conjunction with the automatic anti-dazzle interior mirror ⇨ 30.

Interior mirrors

Manual anti-dazzle



To reduce dazzle, adjust the lever on the underside of the mirror housing.

Automatic anti-dazzle



Press button on mirror housing to turn function on; button illuminates and dazzle from following vehicles at night is automatically reduced. Press button again to turn function off.

There are two light sensors in the mirror housing. To avoid interference and loss of function, do not cover the sensors or hang anything on the mirror.

Windows

Windscreen

Heat-reflecting windscreen

The heat-reflecting windscreen has a coating which reflects solar radiation. Also data signals, e.g. from toll stations, might be reflected.



The marked areas of the windscreen behind the interior mirror are not covered with the coating. Devices for electronic data recording and fee payment must be attached in these areas. Otherwise data recording malfunctions may occur.

Windscreen stickers

Do not attach stickers such as toll road stickers or similar on the windscreen in the area of the interior mirror. Otherwise the detection zone of the sensor could be restricted.

Power windows

⚠ Warning

Take care when operating the power windows. Risk of injury, particularly to children.

If there are children on the rear seats, switch on the child safety system for the power windows.

Keep a close watch on the windows when closing them. Ensure that nothing becomes trapped in them as they move.

Power windows can be operated:

- with ignition on,
- within 10 minutes of switching ignition off.

After switching off the ignition, window operation is disabled when the driver's door is opened.

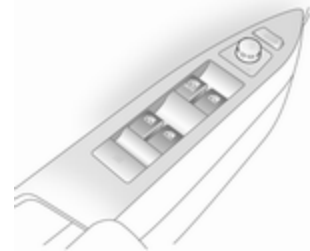

Operate the switch for the respective window by pushing to open or pulling to close.

For incremental operation: Push or pull switch briefly.

For automatic opening or closing: Push or pull switch for longer.

Window moves up or down automatically with safety function enabled. To stop movement, operate the switch once more in the same direction.

Additional switches are located in the front passenger's door and the rear doors. The rear windows do not open fully.

Safety function



If the window glass encounters resistance above the middle of the window during automatic closing, it is immediately stopped and opened again.

Override safety function

In the event of closing difficulties due to frost or the like, pull the relevant window switch several times until the window is closed. The window moves up with the safety function disabled.

Child safety system for rear windows



Press  to deactivate rear door power windows. To reactivate, press  again.

With the child safety system on, rear door windows can only be operated via the switches in the driver's door.

Overload

If the windows are repeatedly operated within short intervals, the window operation is disabled for some time.

Heated rear window



Operated by pressing . LED illuminates in the button.

Heating works with the key in ignition switch positions **ACC** or **ON** and is switched off automatically after a short time.

To avoid discharging the battery, operate only with the engine running. Do not operate when you are just starting the vehicle, or if there is a build up of snow or ice on the rear window.

Do not use sharp instruments or abrasive cleaners on the rear window and avoid scratching or damaging the heating elements.

Sun visors



The sun visors can be folded down or swivelled to the side to prevent dazzling.

Sun visors have vanity mirrors and a ticket holder on the rear. When the vanity mirror covers are opened, the sun visor light illuminates.

The mirror covers should be closed when driving.

Roof

Sunroof

⚠ Warning

Take care when operating the sunroof. Risk of injury, particularly to children.

Keep a close watch on the movable parts when operating them. Ensure that nothing becomes trapped in them as they move.

Slide/tilt sunroof

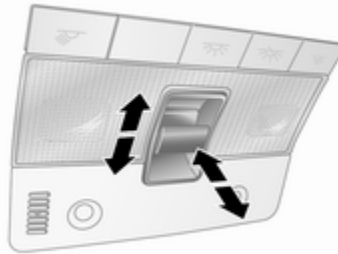

For incremental operation, briefly press the switch in the required direction. For automatic opening or closing, press and hold the switch.

Open

Press switch rearwards; it will open automatically unless the switch is pressed again in another direction, or released.

Note

If the top of the roof is wet, tilt sunroof, allow water to run off and then open sunroof.

Close

Press and hold switch forwards. Release switch when sunroof reaches desired position.

Tilt

Press and hold switch upwards. Release switch when sunroof reaches desired position.

To return sunroof to its original position, pull and hold switch downwards. Release switch when sunroof reaches desired position.

General hints**Function standby**

The sunroof can be operated:

- with ignition on,
- within 10 minutes of switching ignition off,

After switching off the ignition, sunroof operation is disabled when driver's door is opened.

Seats, restraints

Head restraints	35
Active head restraints	36
Front seats	36
Seat position	36
Seat adjustment	37
Seat folding	38
Power seat adjustment	39
Armrest	39
Heating	40
Rear seats	40
Armrest	41
Seat belts	41
Three-point seat belt	42
Airbag system	45
Front airbag system	48
Side airbag system	48
Curtain airbag system	49
Airbag deactivation	50
Child restraints	51
Child restraint systems	51
Child restraint installation locations	52
ISOFIX child restraint systems ..	55
Top-tether fastening eyes	55

Head restraints

Position

⚠ Warning

Only drive with the head restraint set to the proper position.

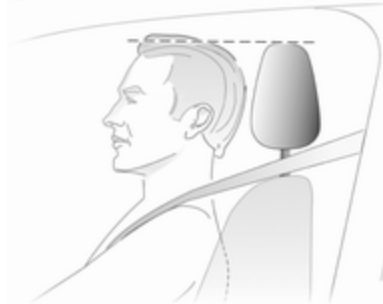

The upper edge of the head restraint should be at upper head level. If this is not possible for extremely tall people, set to highest position, and set to lowest position for small people.

Height adjustment

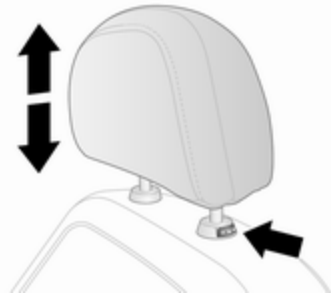

Press release button, adjust height and engage.

Pull head restraint up to raise. Push head restraint down while pressing the release button to lower the head restraint.

Removal

Insert a suitable tool into the small hole in the side of the guide sleeve without the release button and depress the lock. Press the release button on the other guide sleeve and pull up the head restraint.

Stow head restraints securely in load compartment.

Active head restraints

In the event of a rear-end impact, the active head restraints automatically tilt forwards. Thus the head is supported so that the risk of whiplash injury is reduced.

Note

Do not attach objects or components that are not approved for your vehicle to the head restraints. These affect the protective effect of the head restraints and can be propelled through the vehicle in an uncontrolled manner if the driver brakes hard or an accident occurs.

Note

Approved accessories may only be attached if the seat is not in use.

Front seats

Seat position

⚠ Warning

Only drive with the seat correctly adjusted.

⚠ Danger

Do not sit nearer than 25 cm from the steering wheel, to permit safe airbag deployment.

⚠ Warning

Never adjust seats while driving as they could move uncontrollably.

⚠ Warning

Never store any objects under the seats.



- Sit with buttocks as far back against the backrest as possible. Adjust the distance between the seat and the pedals so that legs are slightly angled when pressing the pedals. Slide the front passenger seat as far back as possible.
- Set seat height high enough to have a clear field of vision on all sides and of all display instruments. There should be at least one hand of clearance between head and the roof frame. Your thighs should rest lightly on the seat without pressing into it.

- Sit with shoulders as far back against the backrest as possible. Set the backrest rake so that it is possible to easily reach the steering wheel with arms slightly bent. Maintain contact between shoulders and the backrest when turning the steering wheel. Do not tilt the backrest too far back. We recommend a maximum rake of approximately 25°.
- Adjust seat and steering wheel in a way that the wrist rests on top of the steering wheel while the arm is fully extended and shoulders on the backrest.
- Adjust the steering wheel ⇨ 72.
- Adjust the head restraint ⇨ 35.
- Adjust the height of the seat belt ⇨ 42.
- Adjust the lumbar support so that it supports the natural shape of the spine.

Seat adjustment

⚠ Danger

Do not sit nearer than 25 cm from the steering wheel, to permit safe airbag deployment.

⚠ Warning

Never adjust seats while driving as they could move uncontrollably.

Drive only with engaged seats and backrests.

Longitudinal adjustment



Pull handle, slide seat, release handle.

Backrest inclination



Pull lever, adjust inclination and release lever. Allow the backrest to engage audibly.

Do not lean on the seat backrest whilst adjusting it.

Seat height

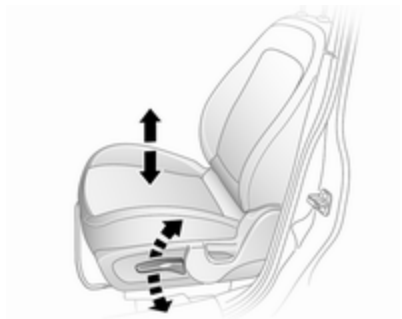

Lever pumping motion

up : seat higher
down : seat lower

Lumbar support

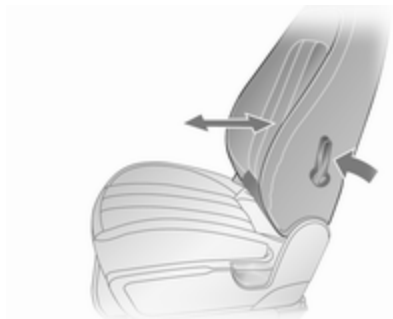

Adjust lumbar support to suit personal requirements using the lever.

To increase or decrease lumbar support, move lever forwards or backwards.

Seat folding

Caution

When seat height is in highest position, push head restraints down and lift up sun visors before folding backrest forwards.



Push head restraint all the way down.

Slide seat as far back as it will go.

Lift release lever and fold backrest down onto seat cushion. Lower lever and backrest engages in lowered position.

Slide seat forwards.

To return the backrest to its original position, slide seat as far back as it will go, lift release lever, move the backrest to upright position, lower lever and the backrest engages.

Folding the backrest forwards is possible only when the backrest is in an upright position.

Do not operate lever to adjust lumbar support with backrest tilted forward.

Power seat adjustment

⚠ Warning

Care must be taken when operating the power seats. There is a risk of injury, particularly for children. Articles could become trapped.

Keep a close watch on the seats when adjusting them. Vehicle passengers should be informed accordingly.

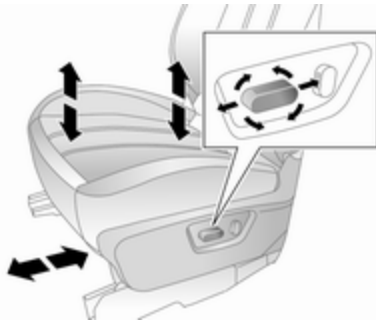

Longitudinal adjustment

Move front switch forwards/backwards.

Seat height

Move front of switch upwards/downwards to adjust height of front part of seat cushion.

Move rear of switch upwards/downwards to adjust height of rear part of seat cushion.

Move front and rear of switch upwards/downwards to adjust height of entire seat cushion.

Backrest inclination



Move upper part of rear switch forwards/backwards.

The seat backrest must not be tilted back too far (recommended maximum tilting angle approx. 25°).

Armrest

Front armrest

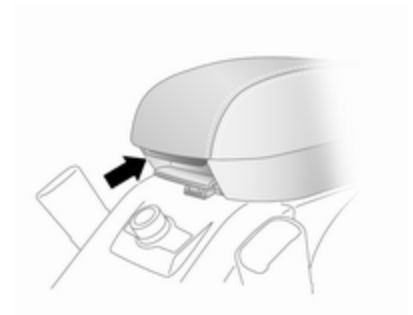



Under the armrest there is a storage compartment.

Armrest storage ⇨ 58.

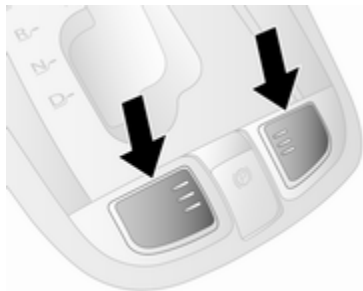
Heating



Adjust heating to the desired setting by pressing  for the respective seat one or more times with the ignition switch set to **ACC** or **ON**. The control indicator in the button indicates the setting.

To deactivate heating, set the heating level to its lowest setting and press . The control indicator in the button will extinguish.

Prolonged use of the highest setting for people with sensitive skin is not recommended.

If temperature continues to rise, turn seat heating off and seek the assistance of a workshop.

Rear seats

Backrest inclination



To adjust seat backrests, lift release lever on top of backrest and move backrest forwards/backwards to desired position.

Do not lean on the backrest whilst adjusting it.

When folding the backrests, ensure the seat belts are unfastened.

⚠ Warning

Never adjust seats while driving as they could move uncontrollably.

Seat folding



The load compartment can be enlarged by folding the seat backrests onto the seat cushions.

To fold backrests separately, unfasten all three rear seat belts and ensure front seats are not in a reclined position.

Push head restraints all the way down, lift backrest release lever and fold backrest forwards and down onto seat cushion.

Do not allow passengers to sit on a folded backrest, or place any unrestrained loads on it.

To move backrest to its original position, lift and push the backrest into place and ensure the backrest engages.

Armrest

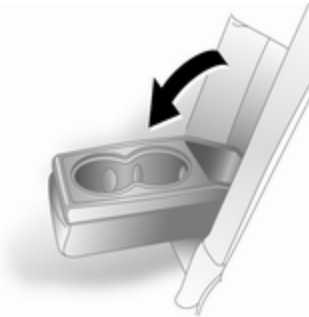

Fold armrest down. The armrest contains cupholders and a storage box.

Seat belts



The seat belts are locked during heavy acceleration or deceleration of the vehicle holding the occupants in the seated position. Thereby the risk of injury is considerably reduced.

⚠ Warning

Fasten seat belt before each trip.

In the event of an accident, people not wearing seat belts endanger their fellow occupants and themselves.

Seat belts are designed to be used by only one person at a time.

Child restraint system ⇨ 51.



Periodically check all parts of the belt system for damage and proper functionality.

Have damaged components replaced. After an accident, have the belts and triggered belt pretensioners replaced by a workshop.

Note

Make sure that the belts are not damaged by shoes or sharp-edged objects or trapped. Prevent dirt from getting into the belt retractors.

Seat belt reminder

Front seats are equipped with a seat belt reminder, indicated for driver seat by control indicator  in the instrument cluster ⇨ 83 and for passenger seat by control indicator  on the passenger side of the instrument panel ⇨ 42.

Belt force limiters

Located on the front seats. Stress on the body is reduced by the gradual release of the belt during a collision.

Belt pretensioners

In the event of a head-on collision or side impact of a certain severity, the front seat belts are tightened.

Warning

Incorrect handling (e.g. removal or fitting of belts) can trigger the belt pretensioners.

Deployment of the belt pretensioners is indicated by illumination of control indicator  ⇨ 83.

Triggered belt pretensioners must be replaced by a workshop. Belt pretensioners can only be triggered once.

Note

Do not affix or install accessories or other objects that may interfere with the operation of the belt pretensioners. Do not make any

modifications to belt pretensioner components as this will invalidate the vehicle type approval.

Three-point seat belt

Fasten



Withdraw the belt from the retractor, guide it untwisted across the body and insert the latch plate into the buckle. Tighten the lap belt regularly whilst driving by pulling the shoulder belt.

Seat belt reminder  ⇨ 83.



Loose or bulky clothing prevents the belt from fitting snugly. Do not place objects such as handbags or mobile phones between the belt and your body.

⚠ Warning

The belt must not rest against hard or fragile objects in the pockets of your clothing.

Height adjustment

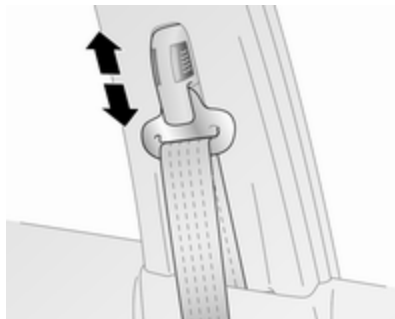

1. Squeeze release buttons together.
2. Slide adjuster up or down.
3. Ensure adjuster latches into position.



Adjust the height so that the belt lies across the shoulder. It must not lie across the throat or upper arm.

Do not adjust while driving.

Unfasten



To release belt, press red button on belt buckle.

Using the seat belt while pregnant





⚠ Warning

The lap belt must be positioned as low as possible across the pelvis to prevent pressure on the abdomen.

Front passenger seat belt reminder



When the engine is running, control indicator  flashes then illuminates if the passenger seat is occupied and the seat belt is not engaged.

If vehicle speed exceeds 22 km/h,  will flash for 100 seconds along with a warning chime, then illuminate until the seat belt is fastened.

Illuminates briefly when ignition is switched on.

Control indicator  for driver's seat belt reminder  83.

Airbag system

The airbag system consists of a number of individual systems depending on the scope of equipment.

When triggered, the airbags inflate within milliseconds. They also deflate so quickly that it is often unnoticeable during the collision.

⚠ Warning

If handled improperly the airbag systems can be triggered in an explosive manner.

Note

The airbag systems and belt pretensioner control electronics are located in the centre console area. Do not put any magnetic objects in this area.



Do not stick anything on the airbag covers and do not cover them with other materials.

Each airbag is triggered only once. Have deployed airbags replaced by a workshop. Furthermore, it might be

necessary to have the steering wheel, the instrument panel, parts of the panelling, the door seals, handles and the seats replaced.

Do not make any modifications to the airbag system as this will invalidate the vehicle type approval.

When the airbags inflate, escaping hot gases may cause burns.

Control indicator  for airbag systems  83.

Child restraint systems on front passenger seat with airbag systems

Warning according to ECE R94.02:



EN: NEVER use a rear-facing child restraint system on a seat protected by an ACTIVE AIRBAG in front of it, DEATH or SERIOUS INJURY to the CHILD can occur.

DE: Nach hinten gerichtete Kindersitze NIEMALS auf einem Sitz verwenden, der durch einen davor befindlichen AKTIVEN AIRBAG geschützt ist, da dies den TOD oder SCHWERE VERLETZUNGEN DES KINDES zur Folge haben kann.

FR: NE JAMAIS utiliser un siège d'enfant orienté vers l'arrière sur un siège protégé par un COUSSIN GONFLABLE ACTIF placé devant lui, sous peine d'infliger des BLESSURES GRAVES, voire MORTELLES à l'ENFANT.

ES: NUNCA utilice un sistema de retención infantil orientado hacia atrás en un asiento protegido por un AIRBAG FRONTAL ACTIVO. Peligro de MUERTE o LESIONES GRAVES para el NIÑO.

RU: ЗАПРЕЩАЕТСЯ устанавливать детское удерживающее устройство лицом назад на сиденье автомобиля,

оборудованном фронтальной подушкой безопасности, если ПОДУШКА НЕ ОТКЛЮЧЕНА! Это может привести к СМЕРТИ или СЕРЬЕЗНЫМ ТРАВМАМ РЕБЕНКА.

NL: Gebruik NOOIT een achterwaarts gericht kinderzitje op een stoel met een ACTIEVE AIRBAG ervoor, om DODELIJK of ERNSTIG LETSEL van het KIND te voorkomen.

DA: Brug ALDRIG en bagudvendt autostol på et forsæde med AKTIV AIRBAG, BARNET kan komme I LIVSFARE eller komme ALVORLIGT TIL SKADE.

SV: Använd ALDRIG en bakåtvänd barnstol på ett säte som skyddas med en framförvarande AKTIV AIRBAG. DÖDSFALL eller ALLVARLIGA SKADOR kan drabba BARNET.

FI: ÄLÄ KOSKAAN sijoita taaksepäin suunnattua lasten turvaistuinta istuimelle, jonka edessä on AKTIIVINEN TURVATYYNY, LAPSI VOI KUOLLA tai VAMMAUTUA VAKAVASTI.

NO: Bakovervendt barnesikringsutstyr må ALDRI brukes på et sete med AKTIV KOLLISJONSPUTE foran, da det kan føre til at BARNET utsettes for LIVSFARE og fare for ALVORLIGE SKADER.

PT: NUNCA use um sistema de retenção para crianças voltado para trás num banco protegido com um AIRBAG ACTIVO na frente do mesmo, poderá ocorrer a PERDA DE VIDA ou FERIMENTOS GRAVES na CRIANÇA.

IT: Non usare mai un sistema di sicurezza per bambini rivolto all'indietro su un sedile protetto da AIRBAG ATTIVO di fronte ad esso: pericolo di MORTE o LESIONI GRAVI per il BAMBINO!

EL: ΠΟΤΕ μη χρησιμοποιείτε παιδικό κάθισμα ασφαλείας με φορά προς τα πίσω σε κάθισμα που προστατεύεται από μετωπικό ΕΝΕΡΓΟ ΑΕΡΟΣΑΚΟ, διότι το παιδί μπορεί να υποστεί ΘΑΝΑΣΙΜΟ ή ΣΟΒΑΡΟ ΤΡΑΥΜΑΤΙΣΜΟ.

PL: NIE WOLNO montować fotelika dziecięcego zwróconego tyłem do kierunku jazdy na fotelu, przed którym znajduje się WŁĄCZONA PODUSZKA POWIETRZNA. Niezastosowanie się do tego zalecenia może być przyczyną ŚMIERCI lub POWAŻNYCH OBRAŻEŃ u DZIECKA.

TR: Arkaya bakan bir çocuk emniyet sistemini KESİNLİKLE önünde bir AKTİF HAVA YASTIĞI ile korumakta olan bir koltukta kullanmayınız. ÇOCUK ÖLEBİLİR veya AĞIR ŞEKİLDE YARALANABİLİR.

UK: НІКОЛІ не використовуйте систему безпеки для дітей, що встановлюється обличчям назад, на сидінні з УВІМКНЕНОЮ ПОДУШКОЮ БЕЗПЕКИ, інакше це може призвести до СМЕРТІ чи СЕРІОЗНОГО ТРАВМУВАННЯ ДИТИНИ.

HU: SOHA ne használjon hátrafelé néző biztonsági gyerekülést előlről AKTÍV LÉGZSÁKKAL védett ülésen, mert a GYERMEK HALÁLÁT vagy KOMOLY SÉRÜLÉSÉT okozhatja.

HR: NIKADA nemojte koristiti sustav zadržavanja za djecu okrenut prema natrag na sjedalu s AKTIVNIM ZRAČNIM JASTUKOM ispred njega, to bi moglo dovesti do SMRTI ili OZBILJNIH OZLJEDA za DIJETE.

SL: NIKOLI ne nameščajte otroškega varnostnega sedeža, obrnjenega v nasprotni smeri vožnje, na sedež z AKTIVNO ČELNO ZRAČNO BLAZINO, saj pri tem obstaja nevarnost RESNIH ali SMRTNIH POŠKODB za OTROKA.

SR: NIKADA ne koristiti bezbednosni sistem za decu u kome su deca okrenuta unazad na sedištu sa AKTIVNIM VAZDUŠNIM JASTUKOM ispred sedišta zato što DETE može da NASTRADA ili da se TEŠKO POVREDI.

MK: НИКОГАШ не користете детско седиште свртено наназад на седиште заштитено со АКТИВНО ВОЗДУШНО ПЕРНИЧЕ пред него, затоа што детето може ДА ЗАГИНЕ или да биде ТЕШКО ПОВРЕДЕНО.

BG: НИКОГА не използвайте детска седалка, гледаща назад, върху седалка, която е защитена

чрез АКТИВНА ВЪЗДУШНА ВЪЗГЛАВНИЦА пред нея - може да се стигне до СМЪРТ или СЕРИОЗНО НАРАНЯВАНЕ на ДЕТЕТО.

RO: Nu utilizați NICIODATĂ un scaun pentru copil îndreptat spre partea din spate a mașinii pe un scaun protejat de un AIRBAG ACTIV în fața sa; acest lucru poate duce la DECESUL sau VĂTĂMAREA GRAVĂ a COPILULUI.

CS: NIKDY nepoužívejte dětský zádržný systém instalovaný proti směru jízdy na sedadle, které je chráněno před sedadlem AKTIVNÍM AIRBAGEM. Mohlo by dojít k VÁŽNĚMU PORANĚNÍ nebo ÚMRTÍ DÍTĚTE.

SK: NIKDY nepoužívajte detskú sedačku otočenú vzad na sedadle chránenom AKTÍVNÝM AIRBAGOM, pretože môže dôjsť k SMRTI alebo VÁŽNÝM ZRANENIAM DIEŤAŤA.

LT: JOKIU BŪDU nemontuokite atgal atgręžtos vaiko tvirtinimo sistemas sėdynėje, prieš kurią įrengta AKTYVI ORO PAGALVĖ, nes VAIKAS GALI ŽŪTI arba RIMTAI SUSIŽALOTI.

LV: NEKĀDĀ GADĪJUMĀ neizmantojiet uz aizmuguri vērstu bērnu sēdekļīti sēdvietā, kas tiek aizsargāta ar tās priekšā uzstādītu AKTĪVU DROŠĪBAS SPILVENU, jo pretējā gadījumā BĒRNS var gūt SMAGAS TRAUMAS vai IET BOJĀ.

ET: ÄRGE kasutage tahapoole suunatud lapseturvaistet istmel, mille ees on AKTIIVSE TURVAPADJAGA kaitstud iste, sest see võib põhjustada LAPSE SURMA või TÕSISE VIGASTUSE.

MT: QATT tuża trażżin għat-tfal li jħares lejn in-naħa ta' wara fuq sit protett b'AIRBAG ATTIV quddiemu; dan jista' jikkawża l-MEWWT jew ĠRIEHI SERJI lit-TFAL.

Beyond the warning required by ECE R94.02, for safety reasons a forward-facing child restraint system must only be used subject to the instructions and restrictions in the table ⇨ 52.

The airbag label may be located on both sides of the front passenger sun visor.

⚠ Danger

Do not use a child restraint system on the passenger seat with active front airbag.

Airbag deactivation ⇨ 50.

Front airbag system

The front airbag system consists of one airbag in the steering wheel and one in the instrument panel on the front passenger side. These can be identified by the word **AIRBAG**.



30036

The warning label reminds that the use of rear-facing child restraint systems on the front passenger seat is not permitted. Risk of fatal injury.

The front airbag system is triggered in the event of a front-end impact of a certain severity. The ignition must be switched on.

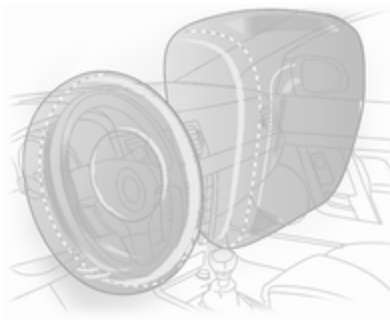

The inflated airbags cushion the impact, thereby considerably reducing the risk of injury to the upper body and head of the front seat occupants.

⚠ Warning

Optimum protection is only provided when the seat is in the proper position ⇨ 36.

Keep the area in which the airbag inflates clear of obstructions.

Fit the seat belt correctly and engage securely. Only then the airbag is able to protect.

Side airbag system

The side airbag system consists of an airbag in each front seat backrest. This can be identified by the word **AIRBAG**.

The side airbag system is triggered in the event of a side impact of a certain severity. The ignition must be switched on.

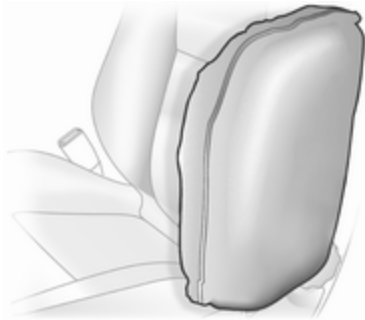

The inflated airbags cushion the impact, thereby considerably reducing the risk of injury to the upper body and pelvis in the event of a side-on collision.

⚠ Warning

Keep the area in which the airbag inflates clear of obstructions.

Note

Only use protective seat covers that have been approved for the vehicle. Be careful not to cover the airbags.

Curtain airbag system

The curtain airbag system consists of an airbag in the roof frame on each side. This can be identified by the word **AIRBAG** on the roof pillars.

The curtain airbag system is triggered in the event of a side-on impact of a certain severity. The ignition must be switched on.

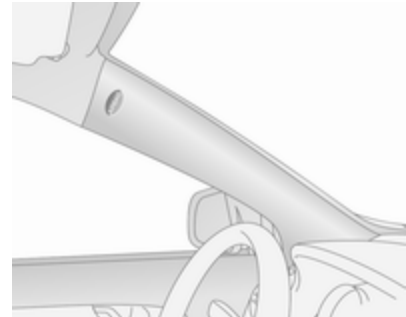

The inflated airbags cushion the impact, thereby considerably reducing the risk of injury to the head in the event of a side-on impact.

⚠ Warning

Keep the area in which the airbag inflates clear of obstructions.

The hooks on the handles in the roof frame are only suitable for hanging up light articles of clothing, without coat hangers. Do not keep any items in these clothes.



Airbag deactivation

The front passenger airbag system must be deactivated for child restraint system on the passenger seat according to the instructions in the table ↗ 52. The belt pretensioners and all driver airbag systems will remain active.



The front passenger airbag system can be deactivated via a key-operated switch on the right side of the instrument panel.

Use the ignition key to choose the position:

-  **OFF** : front passenger airbag systems are deactivated and will not inflate in the event of a collision. Control indicator  illuminates continuously on the passenger side of the instrument panel
-  **ON** : front passenger airbag systems are active

Danger

Deactivate passenger airbag only in combination with the use of a child restraint system, subject to the instructions and restrictions in the tables ↗ 52.

Otherwise, there is a risk of fatal injury for a person occupying a seat with a deactivated front passenger airbag.



Control indicators for the front passenger airbag system are located on the passenger side of the instrument panel.

As long as control indicator is not illuminated, the front passenger airbag system will inflate in the event of a collision.

Change status only when the vehicle is stopped with the ignition off.

Status remains until the next change.

Control indicator  for front passenger airbag ↗ 80.

Child restraints

Child restraint systems

We recommend the Opel child restraint system which is tailored specifically to the vehicle.

When a child restraint system is being used, pay attention to the following usage and installation instructions and also those supplied with the child restraint system.

Always comply with local or national regulations. In some countries, the use of child restraint systems is forbidden on certain seats.

Warning

When using a child restraint system on the front passenger seat, the airbag systems for the front passenger seat must be deactivated; if not, the triggering of the airbags poses a risk of fatal injury to the child.

This is especially the case if rear-facing child restraint systems are used on the front passenger seat.

Airbag deactivation ⇨ 50.

Airbag label ⇨ 45.

Selecting the right system

The rear seats are the most convenient location to fasten a child restraint system.

Children should travel facing rearwards in the vehicle as long as possible. This makes sure that the child's backbone, which is still very weak, is under less strain in the event of an accident.

Suitable are restraint systems that comply with valid UN ECE regulations. Check local laws and regulations for mandatory use of child restraint systems.

Ensure that the child restraint system to be installed is compatible with the vehicle type.

Ensure that the mounting location of the child restraint system within the vehicle is correct, see following tables.

Allow children to enter and exit the vehicle only on the side facing away from the traffic.

When the child restraint system is not in use, secure the seat with a seat belt or remove it from the vehicle.

Note

Do not stick anything on the child restraint systems and do not cover them with any other materials.

A child restraint system which has been subjected to stress in an accident must be replaced.

Child restraint installation locations

Permissible options for fitting a child restraint system

Weight and age class	On front passenger seat		On rear outboard seats	On rear centre seat
	activated airbag	deactivated airbag		
Group 0: up to 10 kg or approx. 10 months	X	U ¹	U, +	X
Group 0+: up to 13 kg or approx. 2 years	X	U ¹	U, +	X
Group I: 9 to 18 kg or approx. 8 months to 4 years	X	U ¹	U, +	X
Group II: 15 to 25 kg or approx. 3 to 7 years	X	X	U	X
Group III: 22 to 36 kg or approx. 6 to 12 years	X	X	U	X

¹ : Child restraint system must be secured using a three-point seat belt. Move seat height adjustment to uppermost position and ensure that vehicle seat belt runs forwards from the upper anchorage point. Adjust seat backrest inclination as far as necessary to a vertical position to ensure that the belt is tight on the buckle side.

+ : Vehicle seat with ISOFIX mounting available. When mounting with ISOFIX, only ISOFIX child restraint systems that have been approved for the vehicle may be used.

U : Universal suitability in conjunction with three-point seat belt.

X : No child restraint system permitted in this weight and age class.

Permissible options for fitting an ISOFIX child restraint system

Weight and age class	Size class	Fixture	On front passenger seat	On rear outboard seats	On rear centre seat
Group 0: up to 10 kg or approx. 10 months	E	ISO/R1	X	IL	X
Group 0+: up to 13 kg or approx. 2 years	E	ISO/R1	X	IL	X
	D	ISO/R2	X	IL	X
	C	ISO/R3	X	IL	X
Group I: 9 to 18 kg or approx. 8 months to 4 years	D	ISO/R2	X	IL	X
	C	ISO/R3	X	IL	X
	B	ISO/F2	X	IUF	X
	B1	ISO/F2X	X	IUF	X
	A	ISO/F3	X	IUF	X
Group II: 15 to 25 kg or approx. 3 to 7 years			X	IL	X
Group III: 22 to 36 kg or approx. 6 to 12 years			X	IL	X

- IL : Suitable for particular ISOFIX restraint systems of the 'vehicle-specific', 'restricted' or 'semi-universal' categories.
The ISOFIX restraint system must be approved for the specific vehicle type.
- IUF : Suitable for ISOFIX forward-facing child restraint systems of universal category approved for use in this weight and age class.
- X : No ISOFIX child restraint system approved in this weight and age class.

ISOFIX size class and seat device

- A - ISO/F3 : Forward-facing child restraint system for children of maximum size in the weight class 9 to 18 kg.
- B - ISO/F2 : Forward-facing child restraint system for smaller children in the weight class 9 to 18 kg.
- B1 - ISO/F2X : Forward-facing child restraint system for smaller children in the weight class 9 to 18 kg.
- C - ISO/R3 : Rear-facing child restraint system for children of maximum size in the weight class up to 18 kg.
- D - ISO/R2 : Rear-facing child restraint system for smaller children in the weight class up to 18 kg.
- E - ISO/R1 : Rear-facing child restraint system for young children in the weight class up to 13 kg.

ISOFIX child restraint systems

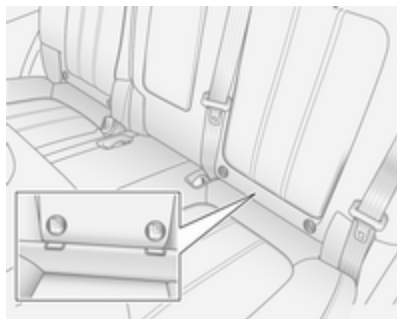

Fasten vehicle-approved ISOFIX child restraint systems to the ISOFIX mounting brackets.

Permitted installation positions for specific vehicle ISOFIX child restraint systems are marked in the table by IL.

No more than two ISOFIX child restraint systems can be installed on the rear seats at the same time, though not on the rear centre seat.

ISOFIX mounting brackets are indicated by a label on the backrest.

Top-tether fastening eyes

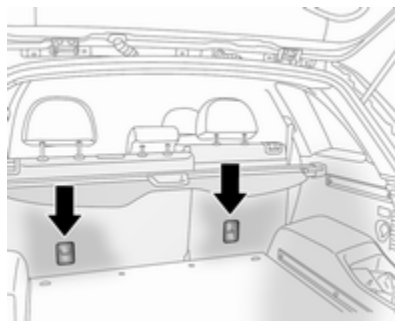

The Top-tether anchors located on the rear of the backrests are designed to hold child restraints which come equipped with Top-tether anchor attachments only. Follow the instructions provided with the Top-tether child restraint system.

For use of ISOFIX and Top-tether fixings, universal ISOFIX child restraint systems may be used. Permitted installation positions are marked in the table by IUF.

Storage

Storage compartments	56
Instrument panel storage	56
Glovebox	57
Cupholders	57
Sunglasses storage	57
Underseat storage	57
Armrest storage	58
Centre console storage	58
Rear carrier system	58
Load compartment	67
Load compartment cover	67
Rear floor storage cover	68
Lashing eyes	69
Warning triangle	69
First aid kit	69
Fire extinguisher	69
Roof rack system	69
Roof rack	69
Loading information	70

Storage compartments

⚠ Warning

Do not store heavy or sharp objects in the storage compartments. Otherwise vehicle occupants could be injured by objects being thrown around in the event of hard braking, a sudden change in direction or an accident.

Instrument panel storage

Console net



Located in the front passenger foot well.

Coin storage



Pull handle to open. Push door firmly to close.

Card holder

Located above the coin storage compartment. A card can be retained in the slot for convenient use.

Glovebox



The glovebox will illuminate when opened.

The glovebox partition can be removed from its groove. Store the partition in the groove on the far left-hand side of the glovebox.

The glovebox should be closed whilst driving.

Lockable glovebox

Lock and unlock the glovebox with the key.

Cupholders

Cupholders are located in the front of the centre console.

The cupholder is flexible, allowing different size drink containers to be stored.

Additional cupholders are located in the centre rear seat armrest. Fold down the armrest to access the cupholder.

Sunglasses storage



To open: push the rear part of the cover.

To close: pull up cover and push it until it latches into place.

Do not use for storing heavy objects.

Underseat storage

Front passenger seat undertray



Pull up on front of tray then pull it forwards. Push the tray towards the seat to return it to its original position.

Armrest storage

Console box in front armrest

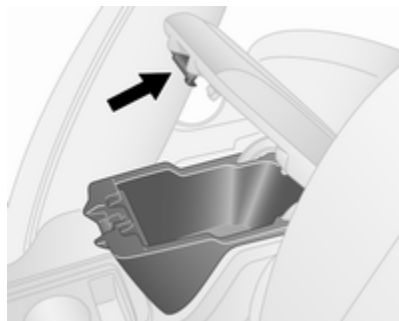

To open: pull up lever and lift the lid.

To close: lower lid and push it down until it latches into position.

Centre console storage

To access the storage compartment, power outlet and AUX input, slide the cupholder tray rearwards.

Power outlets ⇨ 77.

AUX input - see Infotainment system manual for further information.

Rear carrier system

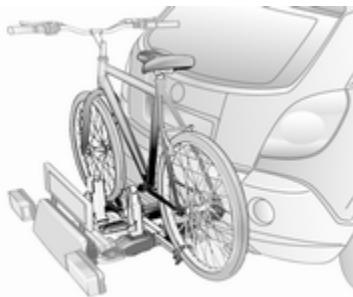

The rear carrier system (Flex-Fix system) allows bicycles to be attached to a pull-out carrier integrated into the vehicle floor. The transportation of other objects is not permitted.

The maximum load of the rear carrier system is 40 kg. The maximum load per bicycle is 20 kg.

The wheelbase of a bicycle must not exceed 1.2 metres. Otherwise the secure fastening of a bicycle is not possible.

If not in use, the carrier system must be slid back into the vehicle floor.

A multifunction box is offered as an accessory for the rear carrier system.

There must not be any objects on the bicycles that could become loose during transportation.

Caution

If the rear carrier system is extended and the vehicle is fully loaded, the chassis clearance will be reduced.

Drive carefully whenever the road has a strong inclination or when driving over a ramp, bump, etc.

Caution

Do not attach bicycles with carbon pedal cranks to bicycle carriers. The bicycles might get damaged.

Extending

Open the tailgate.

⚠ Warning

No-one should be in the extension zone of the rear carrier system, risk of injury.

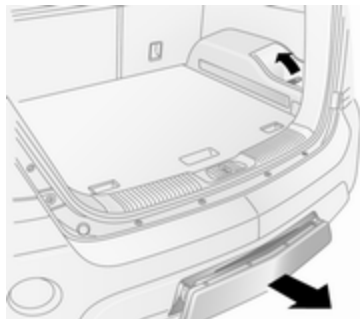

Raise release lever. The system disengages and travels quickly out of the bumper.

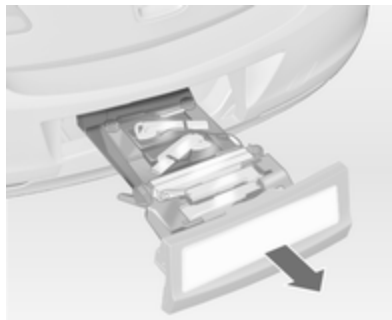

Completely pull out the rear carrier system until you hear it engage. Ensure that it is not possible to push in the rear carrier system without pulling the release lever again.

⚠ Warning

It is only permissible to fit objects to the rear carrier system if the system has been correctly engaged. If the rear carrier system will not engage correctly, do not fit objects to the system and slide the system back. Seek the assistance of a workshop.

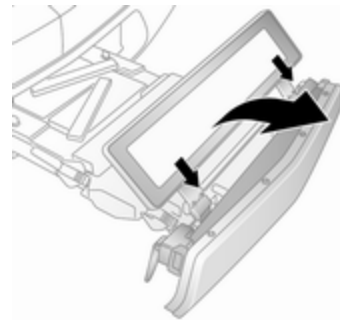

Pull up license plate holder and fully insert the holder supports into the retainers.

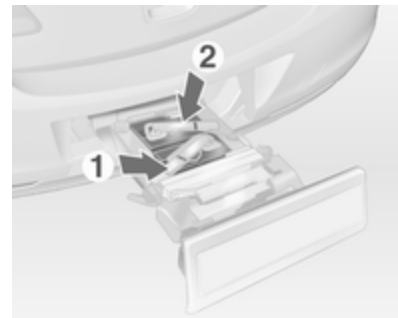
Install the tail lamps

First remove the rear (1), then the front (2) tail lamp from the recesses.

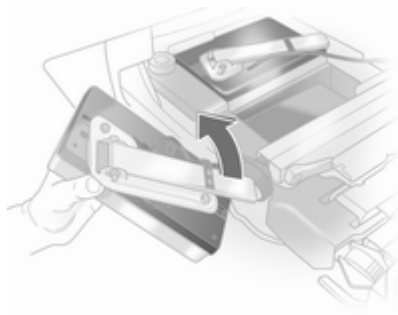

Open out the bulb holder on the back of the tail lamp completely.

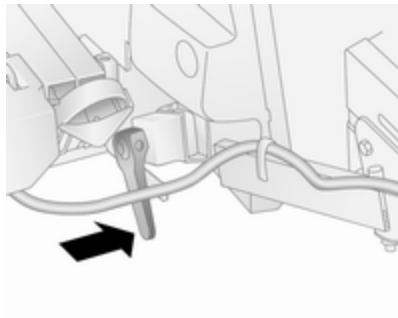

Push the clamping lever and push the bulb holder into the retainer until it hits the stop.

Perform this procedure for both tail lamps.

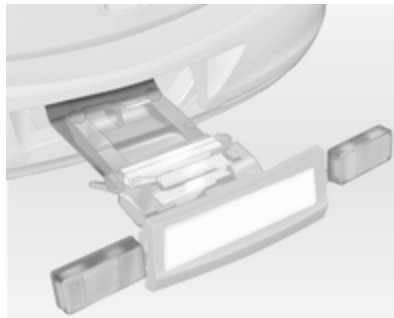

Check the cable and lamp position to make sure these are correctly installed and are securely located.

Lock the rear carrier system

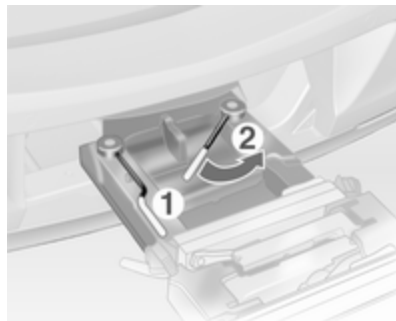

Swivel the left clamping lever (1) back first, followed by the right clamping lever (2) until they stop. Both clamping levers must point backwards, otherwise safe functionality is not guaranteed.

Note

Close the tailgate.

Unfold pedal crank recesses

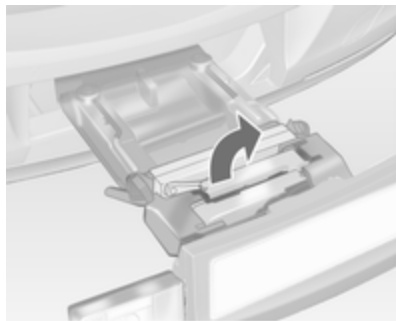

Fold one or both pedal crank recesses upwards until the diagonal support engages.

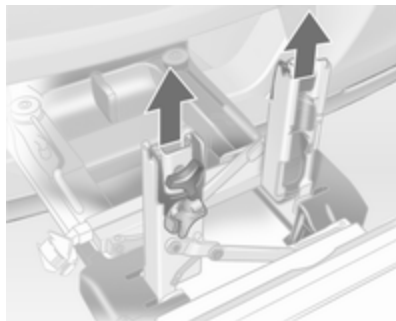

Remove the pedal crank mounts from the pedal crank recesses.

Adapting the rear carrier system to a bicycle

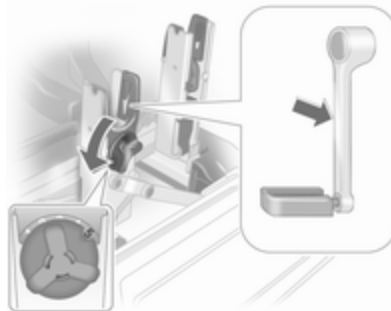

With the rotary lever on the pedal crank recess, roughly adapt the adjustable pedal crank unit to the protrusion of the pedal crank.

If the bicycle has straight pedal cranks, unscrew the pedal crank unit completely (position 5).



If the bicycle has curved pedal cranks, screw in the pedal crank unit all the way (position 1).

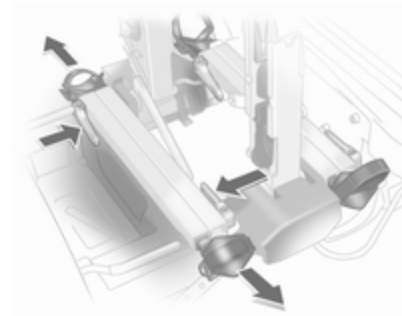

Press the release lever and withdraw the wheel recesses.

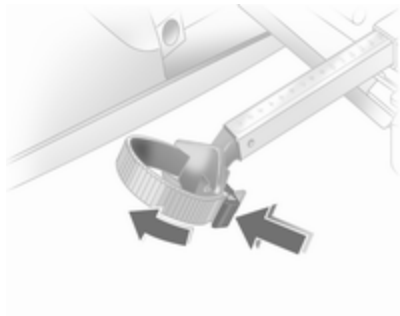

Push the release lever on the strap retainer and remove the strap retainer.

Prepare the bicycle for attachment



Note

The maximum width for the pedal crank is 38.3 mm and the maximum depth is 14.4 mm.

Rotate the left pedal (without a chain cog) vertically downwards. The pedal on the left pedal crank must be horizontal.

The front bicycle must have its front wheel facing left.

The rear bicycle must have its front wheel facing right.

Attaching a bicycle to the rear carrier system

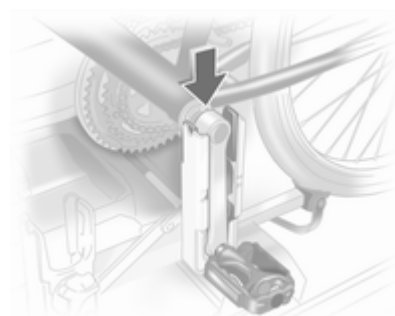

Put on the bicycle. The pedal crank here must be placed in the pedal crank recess opening as shown in the illustration.

Caution

Make sure that the pedal does not touch the surface of the rear end carrier. Otherwise the bicycle crankset might be damaged during transport.

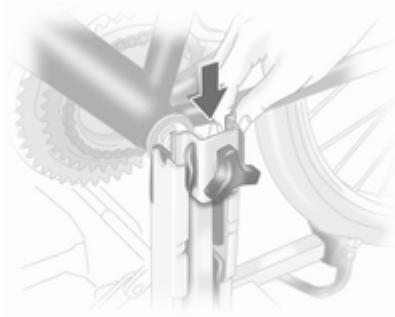

Insert pedal crank mount into outer rail of each pedal crank recess from above and slide downwards as far as it will go.

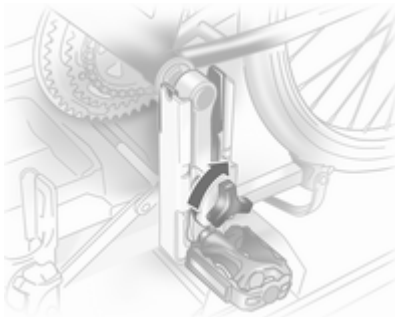

Attach the pedal crank by rotating the attachment screw on the pedal crank mount.



Place the wheel recesses such that the bicycle is more or less horizontal. Here, the distance between the pedals and the tailgate should be at least 5 cm.

Both bicycle tyres must be in the wheel recesses.

Caution

Make sure to pull out the wheel recesses as far as necessary to have both bicycle tyres placed in

the recesses. Otherwise a horizontal mounting of the bicycle is not ensured. Disregard could lead to damage of the bicycle wheels caused by hot exhaust fumes.

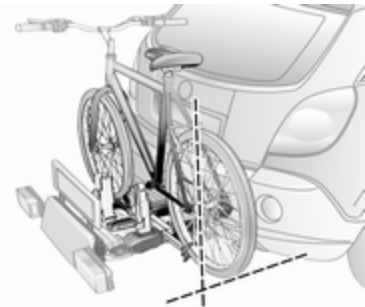

Align the bicycle in the longitudinal direction of the vehicle: Slightly loosen the pedal mount.

Place the bicycle upright using the rotary lever on the pedal crank recess.

If the two bicycles obstruct one another, the relative positions of the bicycles can be adapted by adjusting the wheel recesses and the rotary

lever on the pedal crank recess until the bicycles no longer touch one another. Make sure there is sufficient clearance from the vehicle.

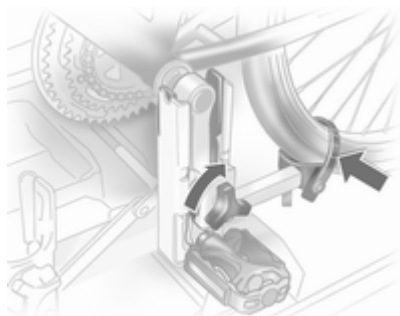

Tighten the attachment screw for the pedal bearing mount to its maximum point by hand.

Secure both bicycle wheels to the wheel recesses using strap retainers. Check the bicycle to make sure it is secure.

Caution

Ensure gap between bicycle and vehicle is at least 5 cm. If necessary, loosen handlebar and swivel sideways.

The settings for the wheel recesses and on the rotary lever on the pedal crank recess should be noted and saved for each bicycle. Correct presetting will facilitate refitting of the bicycle.



Note

It is recommended to attach a warning sign at the rearmost bicycle to increase visibility.

Removing a bicycle from the rear carrier system

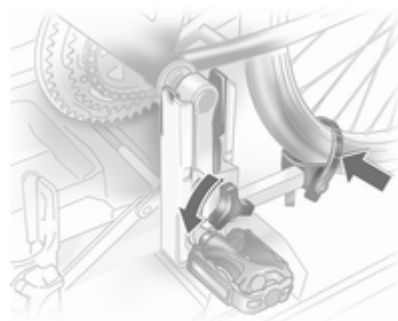

Undo strap retainers on both bicycle tyres.

Hold on to the bicycle, loosen the attachment screw for the pedal bearing mount, then lift the pedal bearing mount to remove it.

Retracting the rear carrier system

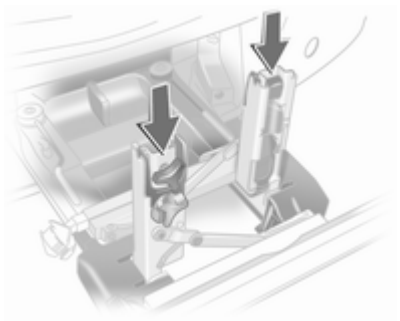

Push the pedal crank mounts into the pedal crank recess as shown in the illustration.

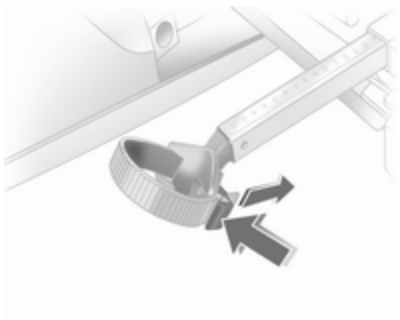

Insert the strap retainer and pull tightly downwards as far as possible.

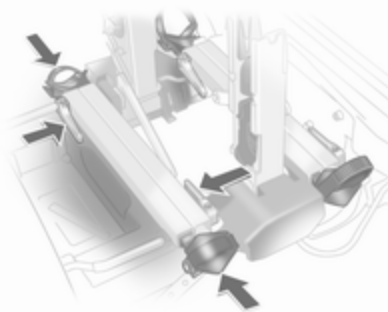

Press release lever and slide in wheel recesses all the way as far as they will go.

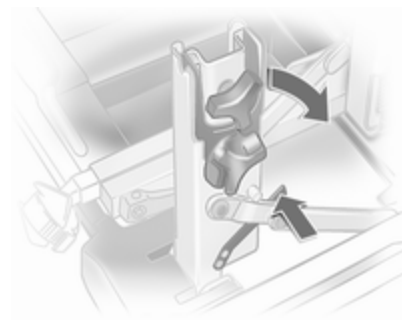

Disengage the locking lever on the diagonal support and fold both pedal crank recesses down.

⚠ Warning

Risk of pinching.

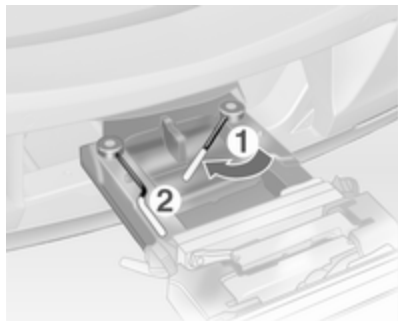

Swivel first the right clamping lever (1) forwards, followed by the left clamping lever (2), until they can be engaged in their respective recesses.

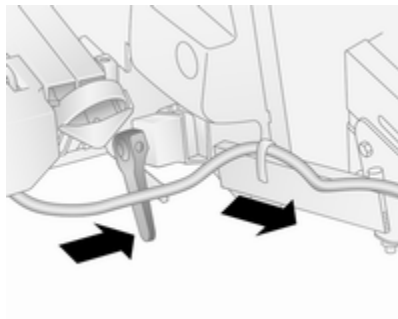

Push the clamping lever down and pull both lamp supports out of the recesses.

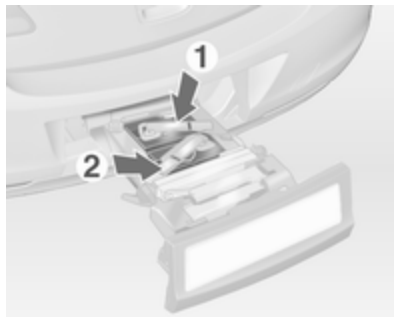

Fold in the bulb holders on the backs of the tail lamps.

First place the front tail lamp (1), then the rear tail lamp (2) in the recesses and push down as far as possible. Push cables all the way into all guides in order to prevent damage.

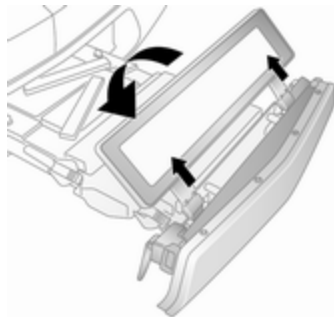

Pull up license plate holder and fold down into horizontal position.

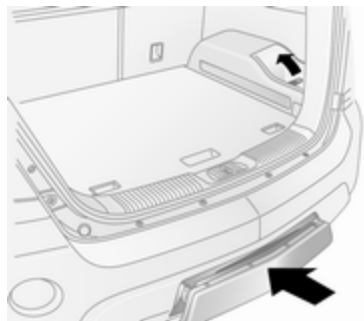

Open the tailgate.

Raise the release lever and hold. Lift the system slightly and push it into the bumper until it engages.

Release lever must return to original position.

⚠ Warning

If the system cannot be correctly engaged, please seek the assistance of a workshop.

Load compartment

Storage compartments in the load compartment

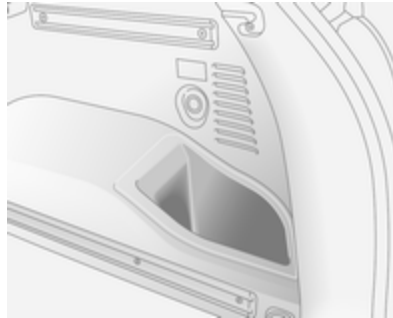

Located on both sides of the load compartment floor.

Load compartment cover

Do not place any objects on the cover.

Closing the cover

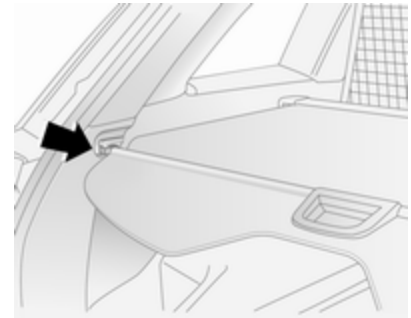

Pull load compartment cover towards rear of vehicle using handle and insert retainers into brackets on either side of load compartment.

Opening the cover

Remove load compartment cover from side brackets. The cover rolls up automatically.

Removing the cover

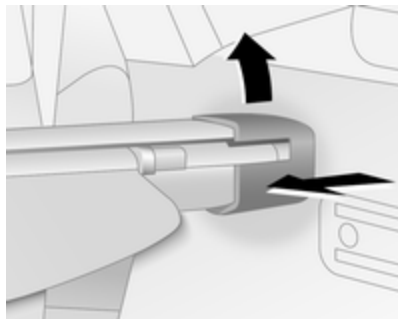

Open load compartment cover. Pull socket on either side of cover towards centre of vehicle, lift and remove cover from the side guides.

Fit in reverse order.

Rear floor storage cover

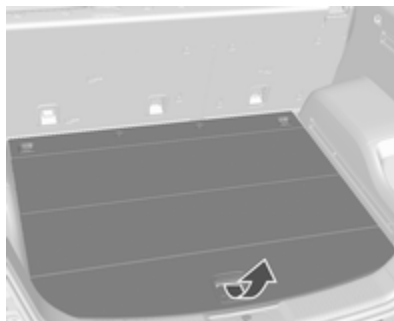

To access the rear floor storage compartment, pull floor cover handle upwards.

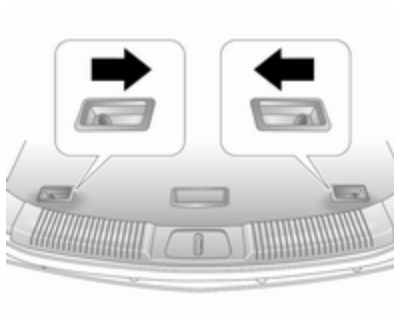

Depending on version, to access the rear floor storage compartment, push both levers on the floor cover towards the handle and pull up the cover by the handle.

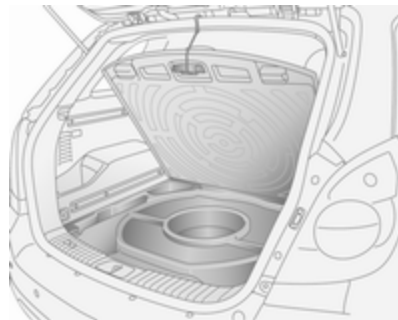

Where present, hang the hook to the upper part of the tailgate opening.

Caution

Only use the hook for hanging up the rear floor cover and the height adjustable cover.

Caution

Do not allow objects to protrude above the top of the rear floor storage compartment, to avoid damage to the storage area and the load compartment floor.

Jack and vehicle tools ⇨ 179.

Tyre repair kit ⇨ 187.

Temporary spare wheel ⇨ 193.

Lashing eyes

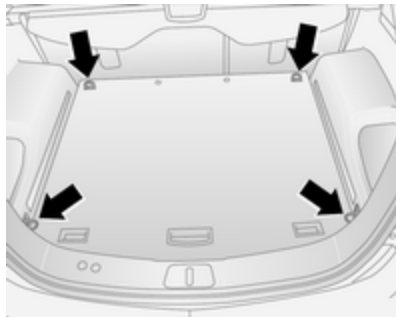

The lashing eyes are designed to secure items against slippage, e.g. using lashing straps or a luggage floor net.

Two additional lashing eyes are located in front of the rear seats.

Designed for carrying small, light items only, a luggage floor net helps keep loads from moving during sharp turns or quick starts and stops.

To install: attach the four net hooks to the lashing eyes mounted on the load compartment floor.

Warning triangle

Stow the warning triangle below the floor cover in the load compartment.

First aid kit

Stow the first aid kit below the floor cover in the load compartment.

Fire extinguisher

Stow the fire extinguisher securely in the load compartment.

Roof rack system

Roof rack

For safety reasons and to avoid damage to the roof, the vehicle approved roof rack system is recommended. For further information contact a workshop.

Fasten the roof rack to the roof rails following the instructions that accompany the system, ensuring that the roof load is evenly distributed over the side or cross rails.

Loads must not be placed on the roof surface. To prevent damage or loss, check frequently that roof loads are securely fastened.

Driving with a roof load affects the vehicle centre of gravity; drive carefully in crosswinds and do not drive at high speeds.

Remove the roof rack when not in use.

Loading information

- Heavy objects in the load compartment should be evenly distributed and placed as far forward as possible. Ensure the backrests are securely engaged. If objects can be stacked, the heavier objects should be placed at the bottom.

With rear seats in the folded position, objects must not be stacked higher than the seat backrests.

- Secure objects with lashing straps attached to lashing eyes ⇨ 69.
- Secure loose objects in the load compartment, e.g. with a luggage floor net, to prevent sliding.
- When transporting objects in the load compartment, the backrests of the rear seats must not be angled forward.
- Do not allow the load to protrude above the upper edge of the backrests.

- Do not place any objects on the load compartment cover or the instrument panel, and do not cover the sensor on top of the instrument panel.
- The load must not obstruct the operation of the pedals, electrical parking brake and gear selector, or hinder the freedom of movement of the driver. Do not place any unsecured objects in the interior.
- Do not drive with an open load compartment.

Warning

Always make sure that the load in the vehicle is securely stowed. Otherwise objects can be thrown around inside the vehicle and cause personal injury or damage to the load or vehicle.

- The payload is the difference between the permitted gross vehicle weight (see identification plate ⇨ 205) and the EC kerb weight.

To calculate the EC kerb weight, enter the data for your vehicle in the weights table at the front of this manual.

The EC kerb weight includes weights for the driver (68 kg), luggage (7 kg) and all fluids (fuel tank 90% full).

Optional equipment and accessories increase the kerb weight.

- Driving with a roof load increases the sensitivity of the vehicle to cross-winds and has a detrimental effect on vehicle handling due to the vehicle's higher centre of gravity. Distribute the load evenly and secure it properly with retaining straps. Adjust the tyre pressure and vehicle speed according to the load conditions. Check and retighten the straps frequently.

Do not drive faster than 120 km/h.

The permissible roof load is 100 kg. The roof load is the combined weight of the roof rack and the load.

Instruments and controls

Controls	72
Steering wheel adjustment	72
Steering wheel controls	72
Horn	72
Windscreen wiper/washer	73
Rear window wiper/washer	74
Outside temperature	75
Clock	75
Power outlets	77
Warning lights, gauges and indicators	78
Instrument cluster	78
Speedometer	78
Odometer	78
Trip odometer	79
Tachometer	79
Fuel gauge	79
Service display	80
Transmission display	80
Control indicators	80
Turn signal	83
Seat belt reminder	83
Airbag and belt tensioners	83
Airbag deactivation	83

Charging system	84
Malfunction indicator light	84
Service vehicle soon	84
Brake system	85
Electrical parking brake	85
Electrical parking brake fault	85
Antilock brake system (ABS)	85
Upshift	86
All wheel drive	86
Sport mode	86
Descent control system	86
Power steering	86
Ultrasonic parking assist	87
Electronic Stability Control	87
Electronic Stability Control off	87
Engine coolant temperature	87
Preheating	87
Diesel particle filter	88
AdBlue	88
Tyre pressure monitoring system	88
Engine oil pressure	88
Change engine oil	89
Low engine oil level	89
Fuel economy mode	89
Low fuel	89
Drain fuel filter	90
Immobiliser	90
Reduced engine power	90
Apply footbrake	90

High beam	90
Automatic headlight levelling system	90
Fog light	90
Rear fog light	91
Cruise control	91
Speed warning	91
Trailer indicator	91
Door open	91
Anti-theft alarm system	91
Information displays	91
Driver Information Centre	91
Board-Info-Display	92
Graphic-Info-Display, Colour-Info-Display	94
Vehicle messages	99
Warning chimes	99
Tyre pressure	99
Trip computer	100
Trip computer in Board-Info-Display	100
Trip computer in Graphic-Info-Display or Colour-Info-Display	102

Controls

Steering wheel adjustment

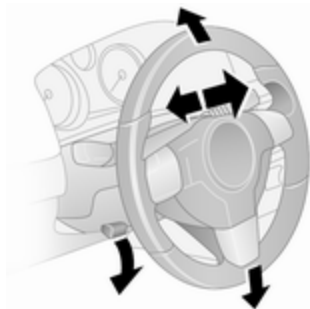

Unlock lever, adjust steering wheel, then engage lever and ensure it is fully locked.

Do not adjust steering wheel unless vehicle is stationary and steering wheel lock has been released.

Steering wheel controls



The Infotainment system and a connected mobile phone can be operated via the controls on the steering wheel.

Further information is available in the Infotainment manual.

Horn



Press .

Windscreen wiper/washer

Windscreen wiper



≡ : fast

— : slow

-- : timed interval wiping or
automatic wiping with rain
sensor

○ : off

For a single wipe when the windscreen wiper is off, press the lever down.

Do not use if the windscreen is frozen.

Switch off in car washes.

Adjustable wiper interval



To set the wiping interval to a value between 1 and 10 seconds:

- Switch on ignition.
- Push lever down from position ○.
- Wait until wiping frequency reaches the desired interval.
- Set lever to position --.

The interval remains stored until the next change or until the ignition is switched off. Switching the ignition on and moving the lever to -- sets the interval to 3.5 seconds.

In this mode, wiping frequency is also affected by vehicle speed. As vehicle speed increases, wiping will become more frequent.

Automatic wiping with rain sensor



-- : automatic wiping with rain sensor

The rain sensor detects the amount of water on the windscreen and automatically regulates the frequency of the windscreen wiper.

The wiper operates for one cycle to check the system when the key is turned to ignition switch position ACC.

To turn wiper off, move lever to position **O**.

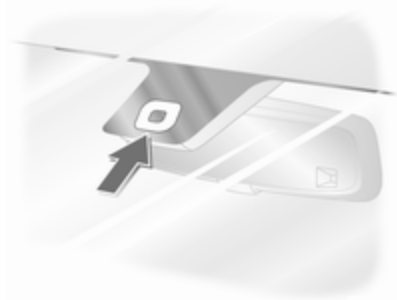

Keep the rain sensor area clean by activating the windscreen washer system.

Windscreen and headlight washer

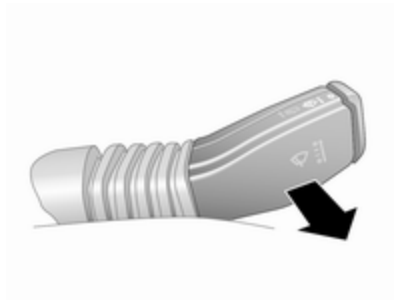

Pull lever. Washer fluid is sprayed onto the windscreen.

If the lever is held longer, the wiper operates for two cycles after the lever has been released and once more after a 3 second delay.

If the headlights are on, washer fluid is also sprayed onto the headlights. The headlight washer system can only be operated again after a short delay. If washer fluid level is low then this delay is increased.

Control indicator  illuminates in the instrument cluster when the washer fluid level is low.

Wiper activated lighting

With light switch in the **AUTO** position, when the windscreen wiper is operated for 8 cycles or more the exterior lights illuminate automatically.

Rear window wiper/washer



Move lever to activate the rear window wiper:

Push lever : wiper on
Pull lever : wiper off

To activate rear window washer system, press and hold button on end of lever. Washer fluid is sprayed onto rear window and the wiper wipes a few times when the button is released.

Do not use if the windscreen is frozen. Switch off in car washes.

Outside temperature



A drop in temperature is indicated immediately and a rise in temperature after a time delay.

If outside temperature drops to 3 °C, the symbol ❄️ illuminates in the Board-Info-Display as a warning for icy road conditions. ❄️ remains illuminated until outside temperature reaches at least 5 °C.



In vehicles with Graphic-Info-Display or Colour-Info-Display, a message appears on the display as a warning for icy road conditions. There is no message below -5 °C.

⚠️ Warning

The road surface may already be icy even though the display indicates a few degrees above 0 °C.

Clock

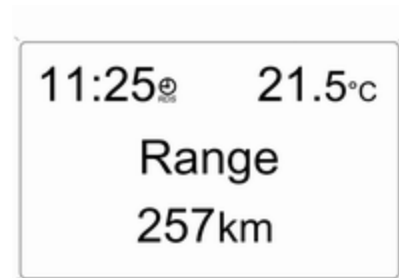

Date and time are shown in the Info-Display.

Board-Info-Display ↪ 92.

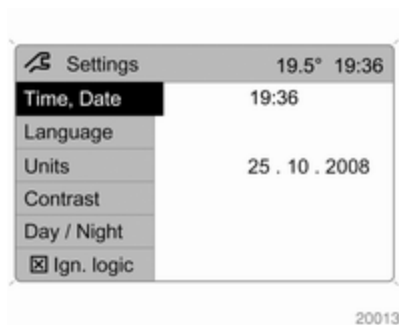

Graphic-Info-Display,
Colour-Info-Display ⇨ 94.

Automatic time synchronisation

Board-Info-Display

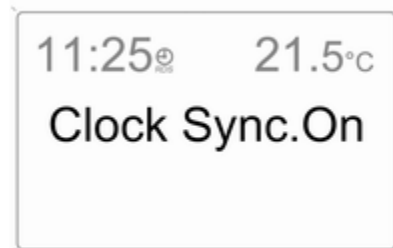

The RDS (Radio Data System) signal of most VHF transmitters automatically sets the time, identified by [Ⓜ] in the display.

Some RDS transmitters do not send a correct time signal. In such cases, switch off automatic time synchronisation and set the time manually.

Deactivate (**Clock Sync.Off**) or activate (**Clock Sync.On**) automatic time synchronisation with the arrow buttons on the Infotainment system.

To set date and time manually, select the menu item for time and date setting from the **Settings** menu and make the desired setting. The value ready for modification is marked with arrows. Use the arrow buttons to make the required setting. The setting is saved when the menu item is exited.

To correct time with the help of RDS, select the menu item for time synchronisation from the **Settings** menu and make the desired setting.

Board-Info-Display ⇨ 92.

Graphic-Info-Display, Colour-Info-Display

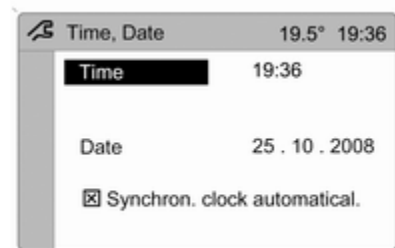

With the navigation system, date and time are set automatically upon receipt of a GPS satellite signal. If the displayed time does not match local time, it can be corrected manually or automatically by receiving an RDS time signal.

Some RDS transmitters do not send a correct time signal. In such cases, switch off automatic time synchronisation and set the time manually.

To set date and time manually, select menu item **Time, Date** from the **Settings** menu. The menu is displayed. Select the menu items required and make the desired setting.

To correct time with the help of RDS, select menu item **Synchron. clock automatical.** from the **Time, Date** menu. The box in front of **Synchron. clock automatical.** will be checked.

Graphic-Info-Display,
Colour-Info-Display ↗ 94.

Power outlets

The outlet can be used to connect electrical accessories.

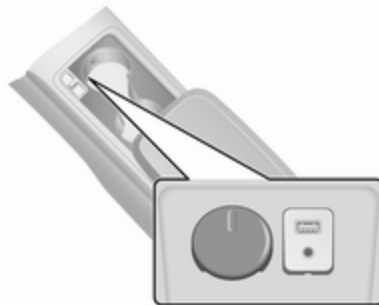

12 Volt power outlets are located beneath the cupholder in the front centre console, in the rear centre console and on the right-hand side of the load compartment.

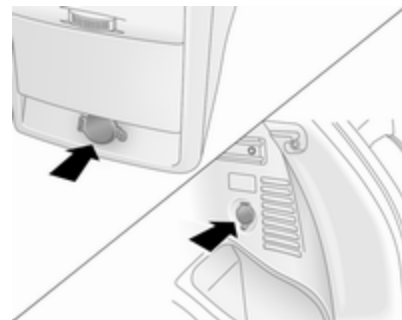

Pull the cap out to use the power outlet, and replace the cap when not in use.

Do not exceed the maximum power consumption of 120 Watts.

Operational with ignition switch in positions **ACC** or **ON**. Use of power outlets while the engine is not running will discharge the battery. Additionally, the power outlets are deactivated in the event of low vehicle battery voltage.

Electrical accessories that are connected must comply with the electromagnetic compatibility requirements laid down in DIN VDE 40 839.

Caution

Do not connect any current-delivering accessories, e.g. electrical charging devices or batteries.

Do not damage the outlets by using unsuitable plugs.

Stop-start system ⇨ 126.

Warning lights, gauges and indicators**Instrument cluster**

In some versions, the needles of the instruments briefly rotate to the end position when the ignition is switched on.

Speedometer

Indicates vehicle speed.

Odometer

The odometer display is shown in the Driver Information Centre ⇨ 91, located in the centre of the instrument cluster.

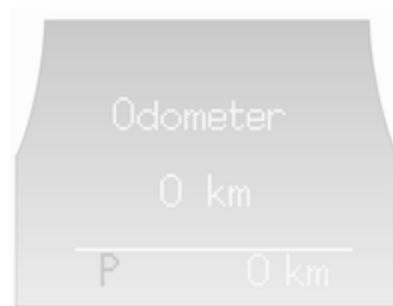

The bottom line displays the recorded distance in km.

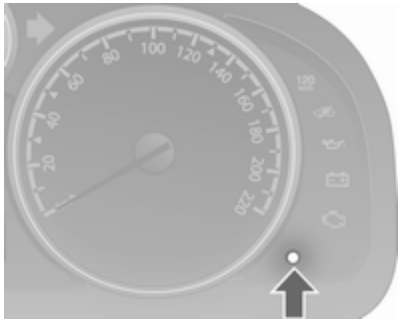

To reset, press and hold the trip odometer button for a few seconds with the ignition on.

Trip odometer

The top line displays the recorded distance since the last reset.

There are two independent trip odometers. Press the trip odometer button once to toggle between Trip A and Trip B.

To reset, press and hold the trip odometer button for a few seconds with the ignition on.

Tachometer



Displays the engine speed.

Drive in a low engine speed range for each gear as much as possible.

Caution

If the needle is in the red warning zone, the maximum permitted engine speed is exceeded. Engine at risk.

Fuel gauge



Displays the fuel level in the tank.

The arrow indicates the vehicle side where the fuel filler flap is located.

Control indicator  illuminates if the level in the tank is low. Refuel immediately ⇨ 150.

Never run the fuel tank dry. Erratic fuel supply can cause catalytic converter to overheat ⇨ 130.

If the tank has been run dry, bleed the fuel system ⇨ 165.

Because of the fuel remaining in the tank, the top-up quantity may be less than the specified tank capacity.
Capacities ⇨ 211.

Service display

The engine oil life system lets you know when to change the engine oil and filter. Based on driving conditions, the interval at which an engine oil and filter change will be indicated can vary considerably.

Change engine oil ⇨ 89.

Service information ⇨ 201.

Transmission display

The transmission display is shown in the Driver Information Centre ⇨ 91, located in the centre of the instrument cluster.

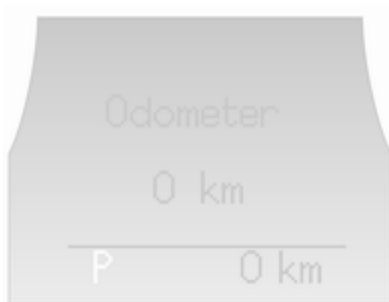

Displays the mode or selected gear with automatic transmission.

- P** : park position
- R** : reverse gear
- N** : neutral
- D** : drive position (automatic mode)
- 1-6 : selected gear in manual mode

Control indicators

The control indicators described are not present in all vehicles. The description applies to all instrument versions.

Depending on the equipment, the position of the control indicators may vary.

When the ignition is switched on, most control indicators will illuminate briefly as a functionality test.

The control indicator colours mean:

- red : danger, important reminder
- yellow : warning, information, fault
- green : confirmation of activation
- blue : confirmation of activation
- white : confirmation of activation

Control indicators on the instrument panel





Overview

 Turn signal ⇨ 83

 Driver's seat belt reminder
⇨ 83

 Front passenger seat belt
reminder ⇨ 83

 Airbag and belt tensioners
⇨ 83

 Airbag activation ⇨ 83

 Charging system ⇨ 84

 Malfunction indicator light
⇨ 84

 Service vehicle soon ⇨ 84

 Brake system ⇨ 85

 Electrical parking brake
⇨ 85

 Electrical parking brake fault
⇨ 85

 Antilock brake system (ABS)
⇨ 85

 Upshift ⇨ 86

 All wheel drive ⇨ 86

SPORT Sport mode ⇨ 86

 Descent control system
⇨ 86

 Power steering ⇨ 86

P  Ultrasonic parking assist
⇨ 87

 Electronic Stability Control
⇨ 87

 Electronic Stability Control
off ⇨ 87

 Engine coolant temperature
⇨ 87

 Preheating ⇨ 87

 Diesel particle filter ⇨ 88

 AdBlue ⇨ 88

 Tyre pressure monitoring
system ⇨ 88

 Engine oil pressure ⇨ 88

 Change engine oil ⇨ 89

 Low engine oil level ⇨ 89

ECO Fuel economy mode ⇨ 89

 Low fuel ⇨ 89

 Drain fuel filter ⇨ 90

 Immobiliser ⇨ 90

 Reduced engine power
⇨ 90

 Apply footbrake ⇨ 90

 High beam ⇨ 90

 Automatic headlight levelling
system ⇨ 90



 Fog light ⇨ 90

 Rear fog light ⇨ 91

 Cruise control ⇨ 91

 Speed warning ⇨ 91

 Trailer indicator ⇨ 91

-  Door open ⇨ 91
-  Anti-theft alarm system
⇨ 91

Turn signal

 illuminates or flashes green.

The relevant control indicator flashes when the turn signal is switched on ⇨ 108.

Rapid flashing: failure of a turn signal bulb or the associated fuse or failure of a turn signal light on trailer.

Both control indicators flash when the hazard warning flashers are active ⇨ 107.

Bulb replacement ⇨ 165, Fuses
⇨ 171.

Turn signals ⇨ 108.

Seat belt reminder

Seat belt reminder for front seats

 for driver's seat illuminates or flashes red.

 for front passenger's seat illuminates or flashes red, when the seat is occupied.

When the engine is running, if seat belt is not engaged, the control indicator will flash for 100 seconds then illuminate until seat belt is fastened.

If vehicle speed exceeds 22 km/h, the control indicator will flash for 100 seconds along with a warning chime and remains illuminated until seat belt is fastened.

Fastening the seat belt ⇨ 41.

Front passenger seat belt reminder  ⇨ 42.

Airbag and belt tensioners

 illuminates red.

When the ignition is switched on,  flashes briefly. If it does not flash, stays lit or flashes during driving, there is a fault in the airbag system. Seek the assistance of a workshop. The airbags and belt pretensioners may fail to trigger in the event of an accident.

Deployment of the belt pretensioners or airbags is indicated by continuous illumination of .

Warning

Have the cause of the fault remedied immediately by a workshop.

Belt pretensioners, airbag system
⇨ 41, ⇨ 45.

Airbag deactivation

 illuminates yellow.

The front passenger airbag is deactivated.

⚠ Danger

Risk of fatal injury for a child using a child restraint system together with activated front passenger airbag.

Risk of fatal injury for an adult person with deactivated front passenger airbag.

Airbag deactivation ⇨ 50.

Charging system

 illuminates red.

Illuminates when the ignition is switched on and extinguishes shortly after the engine starts. If it does not illuminate, seek the assistance of a workshop.

Illuminates when the engine is running

Stop vehicle and switch off engine. Battery is not charging. Engine cooling may be interrupted. The brake servo unit may cease to be effective.

Interrupt your journey immediately. Remove key and check drive belt condition and tensioning before seeking the assistance of a workshop.

Malfunction indicator light

 illuminates or flashes yellow.

Illuminates when the ignition is switched on and extinguishes shortly after the engine starts. If it does not illuminate, seek the assistance of a workshop.

Can illuminate briefly when driving; this is normal and does not indicate a system fault.

Illuminates when the engine is running

Fault in the emission control system. The permitted emission limits may be exceeded. Fuel economy and vehicle driveability may be impaired. Seek the assistance of a workshop immediately.

Control indicator  also illuminates if there is a fault in the diesel particle filter ⇨ 129 or with the automatic

transmission ⇨ 138. Seek the assistance of a workshop as soon as possible.

Ensure the fuel filler cap is screwed in completely ⇨ 150.

Flashes when the engine is running

Fault that could lead to catalytic converter damage ⇨ 130. Ease up on the accelerator until the flashing stops. Seek the assistance of a workshop immediately.

Service vehicle soon

 illuminates yellow.

Illuminates when the engine is running to indicate a fault in the engine or transmission electronics. The electronics switch to an emergency running programme, fuel consumption may be increased and vehicle handling may be impaired.

In some cases, the fault can be eliminated by switching the engine off and back on again. If  illuminates again after restarting the engine, the vehicle may need a service.

Have the cause of the fault eliminated by a workshop.

Brake system

(1) illuminates red.

Illuminates when the ignition is switched on and extinguishes shortly after the engine starts. If it does not illuminate, stop and seek the assistance of a workshop.

Control indicator (1) illuminates if the electrical parking brake is applied and extinguishes when it is released ⇨ 143.

If it stays lit while the engine is running, the brakes do not operate as normal, or leaks are found in the brake system, do not attempt to drive the vehicle. Have the vehicle towed to a workshop for inspection and repair.

Warning

Stop. Do not continue your journey. Consult a workshop.

Illuminates when engine is running if the fluid level for brake hydraulics is too low ⇨ 162.

Brake system ⇨ 142.

Electrical parking brake

(P) illuminates or flashes red.

When the engine is started, (P) illuminates briefly. If it does not illuminate, seek the assistance of a workshop.

Illuminates

Electrical parking brake is applied ⇨ 143.

Flashes

Electrical parking brake is not fully applied or released.

Switch on ignition, depress brake pedal and attempt to reset the system by first releasing and then re-applying the electrical parking brake.

If (P) remains flashing, do not drive and seek the assistance of a workshop.

Electrical parking brake fault

(P) illuminates yellow.

When the ignition is switched on, (P) illuminates briefly. If it does not illuminate, seek the assistance of a workshop.

Illuminates

Electrical parking brake is operating with degraded performance ⇨ 143.

Warning



Have the cause of the fault remedied immediately by a workshop.

Antilock brake system (ABS)

(ABS) illuminates yellow.

Illuminates for a few seconds after the ignition is switched on. The system is ready for operation when the control indicator extinguishes.

If the control indicator does not illuminate when the ignition is switched on, stays lit or illuminates during driving, there is a fault in the ABS. The brake system remains operational but without ABS regulation.

If control indicator  illuminates during driving along with brake system control indicator , there is a serious fault in the brake system. Have the system checked immediately by a workshop.

Antilock brake system ⇨ 142.

Upshift

 illuminates green.

Upshifting is recommended for fuel saving purposes.

All wheel drive

 illuminates or flashes yellow.

Illuminates briefly when the ignition is switched on. If it does not illuminate, seek the assistance of a workshop.

Flashes briefly when the engine is running

The system is temporarily disabled.

Flashes continuously when the engine is running

System fault. Seek the assistance of a workshop immediately.

All wheel drive ⇨ 140.

Sport mode

SPORT illuminates green.

Illuminates when Sport mode is switched on ⇨ 137.

Descent control system

 illuminates yellow and/or green.

Both the yellow and green control indicators illuminate briefly when the ignition is switched on.

Green

Illuminates when system is ready for operation.

Flashes during driving when system is in operation, after pressing the  button.

Yellow

Flashes to indicate system is not ready for conditions to operate.

Illuminates to indicate there is a fault in the system.

If it flashes or illuminates during driving, friction material needs to cool down: drive the vehicle without braking as much as possible.

Descent control system ⇨ 146.

Power steering

 illuminates yellow.

When the ignition is switched on,  illuminates briefly. If it does not illuminate, stays lit or illuminates during driving, there is a fault in the system. Seek the assistance of a workshop.

Power steering ⇨ 124.

Ultrasonic parking assist

 illuminates yellow.

Fault in system

or

Fault due to sensors that are dirty or covered by ice or snow

or

Interference due to external sources of ultrasound. Once the source of interference is removed, the system will operate normally.

Have the cause of the fault in the system remedied by a workshop.

Ultrasonic parking assist ⇨ 148.

Electronic Stability Control

 illuminates or flashes yellow.

When the engine is started,  illuminates briefly. If it does not illuminate, seek the assistance of a workshop.

Illuminates

Fault in the system. Continued driving is possible. Driving stability, however, may deteriorate depending on road surface conditions.

Have the cause of the fault remedied by a workshop.

Flashes

The system is actively engaged. Engine output may be reduced and the vehicle may be braked automatically to a small degree.

Electronic Stability Control ⇨ 145.

Electronic Stability Control off

 illuminates yellow.

When the ignition is switched on,  illuminates briefly. If it does not illuminate, seek the assistance of a workshop.

Illuminates when ESC has been switched off manually by pressing button  on the centre console.

Electronic Stability Control ⇨ 145.

Engine coolant temperature

 illuminates red.

When the engine is started,  illuminates briefly. If it does not illuminate, seek the assistance of a workshop.

Illuminates when the engine is running

Stop vehicle and switch off engine.

Caution
Coolant temperature too high.

Check coolant level ⇨ 160.

If there is sufficient coolant, seek the assistance of a workshop.

Preheating

 illuminates yellow.

Preheating is activated. Only activates when outside temperature is low. Start the engine when control indicator extinguishes.

If it illuminates during driving or if the engine cannot be started, seek the assistance of a workshop as soon as possible.

Starting the engine ⇨ 125.

Diesel particle filter

☞ illuminates or flashes yellow.

The diesel particle filter requires cleaning.

Continue driving until ☞ extinguishes.

Illuminates during driving

Control indicator ☞ illuminates, accompanied by a warning chime, when the diesel particle filter is full. Start cleaning process as soon as possible.

Flashes during driving

Control indicator ☞ flashes when the maximum filling level of the filter is reached. Start cleaning process immediately to avoid damage to the

engine. A warning chime sounds every 3 minutes until the cleaning process is complete.

Diesel particle filter ⇨ 129, Stop-start system ⇨ 126.

AdBlue

☞ flashes yellow.

AdBlue level is low. Refill AdBlue as soon as possible, to avoid prevention of engine starts.

A corresponding message may also appear in the Driver Information Centre ⇨ 91.

AdBlue ⇨ 131.

Tyre pressure monitoring system

⚠ illuminates or flashes yellow.

Illuminates

Tyre pressure loss. Stop immediately and check tyre pressure.

A corresponding message also appears on the Info-Display ⇨ 92.

Flashes

Fault in system or tyre without pressure sensor mounted (e.g. spare wheel). After approx. one minute the control indicator illuminates continuously. A corresponding message also appears on the Info-Display.

Consult a workshop.

Tyre pressure monitoring system ⇨ 183.

Engine oil pressure

☞ illuminates red.

Illuminates when the ignition is switched on and extinguishes shortly after the engine starts. If it does not illuminate, seek the assistance of a workshop.

Illuminates when the engine is running

Caution

Engine lubrication may be interrupted. This may result in damage to the engine and/or locking of the drive wheels.

1. Depress clutch.
2. Select neutral gear, set selector lever to **N**.
3. Move out of the flow of traffic as quickly as possible without impeding other vehicles.
4. Switch off ignition.

⚠ Warning

When the engine is off, considerably more force is needed to brake and steer. During an Autostop the brake servo unit will still be operational.

Do not remove key until vehicle is stationary, otherwise the steering wheel lock could engage unexpectedly.

Check oil level before seeking the assistance of a workshop ⇨ 159.

Change engine oil

 illuminates yellow.

When the engine is started,  illuminates briefly. If it does not illuminate, seek the assistance of a workshop.

The engine oil life monitor lets you know when to change the oil. Control indicator  illuminates to indicate that engine oil life has been diminished and the oil needs changing.

Based on driving conditions, the interval at which an oil change will be indicated can vary considerably.

Change oil within 1000 km. Engine power may be decreased.

Once the engine oil has been changed ⇨ 159, the engine oil life monitor needs to be reset. Seek the assistance of a workshop.

Low engine oil level

 illuminates yellow.

When the ignition is switched on,  illuminates briefly. If it does not illuminate, seek the assistance of a workshop.

Illuminates during driving

Oil level is low: top up oil to specified level ⇨ 159.

Fuel economy mode

ECO illuminates green.

Depending on version, **ECO** illuminates when fuel economy mode is switched on ⇨ 122.

Low fuel

 illuminates yellow.

When the engine is started,  illuminates briefly. If it does not illuminate, seek the assistance of a workshop.

Illuminates during driving when fuel level in tank is too low. Refuel immediately ⇨ 150.

Never run the tank dry. Erratic fuel supply can cause catalytic converter to overheat ⇨ 130.

If the tank has been run dry, bleed the fuel system ⇨ 165.

Fuel tank capacity ⇨ 211.

Catalytic converter ⇨ 130.

Drain fuel filter

 illuminates yellow.

Illuminates when water level in diesel fuel filter exceeds a specified level.

Residual water in the diesel fuel filter must be drained ⇨ 164. Seek the assistance of a workshop as soon as possible.

Immobiliser

 illuminates red.

When the engine is started,  illuminates briefly. If it does not illuminate, seek the assistance of a workshop.

Illuminates to indicate a fault in the immobiliser system. The engine cannot be started.

Electronic immobiliser ⇨ 28.

Reduced engine power

 illuminates yellow.

Illuminates in conjunction with control indicator ; the vehicle needs a service. Move out of the flow of traffic as quickly as possible without impeding other vehicles, stop the engine and restart after 10 seconds.

The engine power is limited. Consult a workshop.

Apply footbrake

 illuminates yellow.

Brake pedal must be depressed to release the electrical parking brake ⇨ 143.

Clutch pedal must be depressed to restart the engine.

Stop-start system ⇨ 126.

High beam

 illuminates blue.

Illuminated when high beam is on and during headlight flash ⇨ 106.

Automatic headlight levelling system

 illuminates yellow

Illuminates during driving to indicate a fault that requires immediate attention. Seek the assistance of a workshop as soon as possible.

Automatic headlight range adjustment ⇨ 106.

Fog light

 illuminates green.

Illuminates when the front fog lights are switched on ⇨ 108.

Rear fog light

 illuminates yellow.

Illuminates when the rear fog light is switched on ⇨ 109.

Cruise control

 illuminates yellow or green.

Illuminates yellow

The system is ready for operation.

Illuminates green

A certain speed is stored.

Cruise control ⇨ 147.

Speed warning

 illuminates yellow.

In vehicles equipped with the overspeed warning light, when vehicle speed exceeds 120 km/h, control indicator  flashes, accompanied by a warning chime, to warn the driver to reduce speed as appropriate.

Trailer indicator

 illuminates green.

Illuminates when a trailer is connected to the vehicle ⇨ 152.

Door open

 illuminates red.

Illuminates when a door is open or not securely latched.

Anti-theft alarm system

 illuminates yellow.

Illuminates when alarm system monitoring of the passenger compartment and vehicle inclination has been switched off with button  in the roof console.

Anti-theft alarm system ⇨ 26.

Information displays

Driver Information Centre

The Driver Information Centre is located in the centre of the instrument cluster.

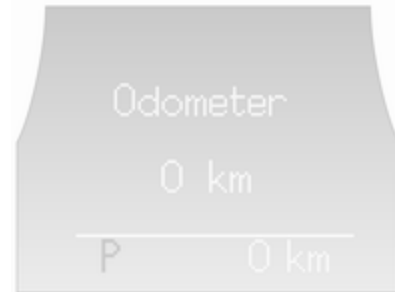

Depending on vehicle configuration, the following items appear in the display:

- odometer ⇨ 78
- trip odometer ⇨ 79
- transmission display ⇨ 80
- Adblue warning messages ⇨ 131

Board-Info-Display

The Info-Display is located in the instrument panel above the Infotainment system.



20005

Info-Display indicates:

- time ↻ 75
- outside temperature ↻ 75
- date ↻ 75
- Infotainment system - see Infotainment manual

An F in the display indicates a fault. Have the cause of the fault remedied by a workshop.

Trip computer, Board-Info-Display
↻ 100.

Selecting functions

Functions and settings of the Infotainment system can be accessed via the Info-Display.

Functions are selected and executed in the menu on the display using the arrow buttons on the Infotainment system or the left adjuster wheel on the steering wheel.

If a check control warning message appears on the Info-Display, the display is blocked from other functions. Acknowledge the message by pressing **OK** or the left adjuster wheel. If there are several warning messages, acknowledge them one at a time.

Check control ↻ 99.

Select using the Infotainment system buttons

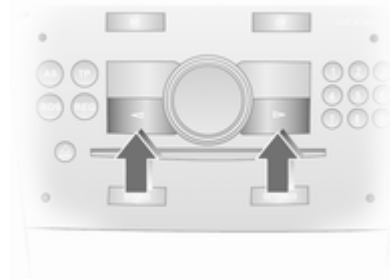

In the **Settings** menu, press **OK** to call up the required function. Use the arrow buttons to change settings.

In the **BC** menu, press **OK** to call up the required function. Press **OK** to operate the stop watch or restart measurement and calculation.

Select using the left adjuster wheel on the steering wheel



Turn the adjuster wheel to call up the required function.

Press the adjuster wheel to open the **BC** menu, to select marked items and confirm commands. In the **BC** menu press to operate the stop watch or restart measurement and calculation.

System settings

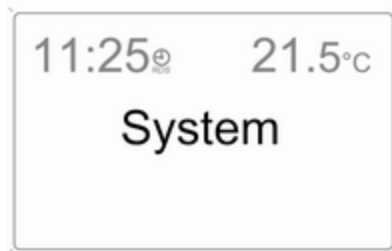

20006

Press **Settings** on the Infotainment system. Menu item Audio then opens.

Call up **System** with the left arrow button and select by pressing **OK**.

The first function of the **System** menu is highlighted. Some of the functions appear on the display in an abbreviated form.

The functions are displayed in the following order:

- Time synchronisation
- Time, setting hours
- Time, setting minutes
- Date, setting day

- Date, setting month
- Date, setting year
- Ignition logic
- Language selection
- Setting units of measure

Automatic time synchronisation

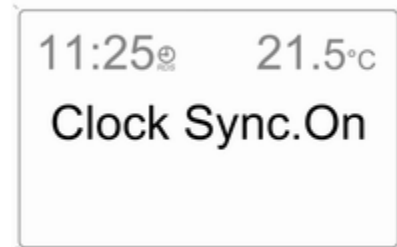

20007

The RDS (Radio Data System) signal of most VHF transmitters automatically sets the time, identified by  in the display.

Some transmitters do not send a correct time signal. In such cases, switch off automatic time synchronisation and set the time manually.

Deactivate (**Clock Sync.Off**) or activate (**Clock Sync.On**) automatic time synchronisation with the arrow buttons.

Setting date and time

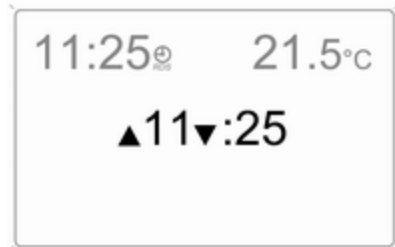

20008

To set date and time manually, select the menu item for time and date settings and make the desired setting.

The value ready for modification is marked with arrows. Use the arrow buttons to make the required setting. The setting is saved when the menu item is exited.

Ignition logic

See Infotainment manual.

Language selection

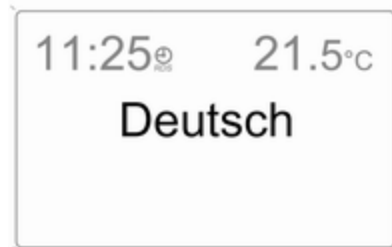

20009

The display language for some functions can be selected.

Select the required language with the arrow buttons.

Setting units of measure

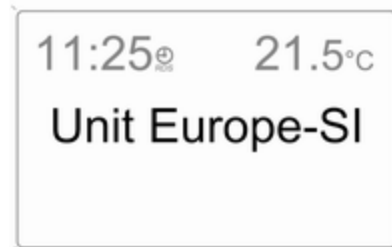

20010

Select the required unit of measurement with the arrow buttons.

Graphic-Info-Display, Colour-Info-Display

Depending on the vehicle configuration the vehicle has a Graphic-Info-Display or Colour-Info-Display. The Info-Display is located in the instrument panel above the Infotainment system.



Info-Display indicates:

- time ↻ 75
- outside temperature ↻ 75
- date ↻ 75
- Infotainment and navigation systems - see Infotainment manual
- system settings

The Graphic-Info-Display presents the information in monochrome. The Colour-Info-Display presents the information in colour.

The type of information and how it is displayed depends on the equipment of the vehicle and the settings of the

trip computer and Infotainment system. Some information appears on the display in an abbreviated form. An F in the display indicates a fault. Have the cause of the fault remedied by a workshop.

Trip computer, Graphic-Info-Display, Colour-Info-Display ↻ 102.

Selecting functions

The functions and settings of the Infotainment system can be accessed via the Info-Display.

Functions are selected and executed in the menu on the display using the arrow buttons and the central multifunction knob on the Infotainment system or the left adjuster wheel on the steering wheel.

If a check control warning message appears on the Info-Display, the display is blocked from other functions. Acknowledge the message by pressing an arrow button, the multifunction knob or the left adjuster wheel. If there are several warning messages, acknowledge them one at a time.

Check control ↻ 99.

Select using the Infotainment system buttons

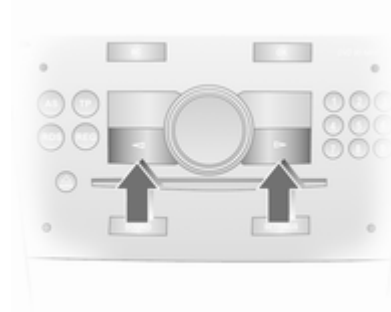

Select a function via the Infotainment system arrow buttons. The menu of the selected function is displayed.

Select using the central multifunction knob

The multifunction knob is the central control element for the menus:

Turn

- To mark a menu option
- To set a numeric value or to display a menu option

Press

- To select or activate the marked option
- To confirm a set value
- To switch a system function on/off

To exit a menu, turn the multifunction knob left or right to **Return** or **Main** and select.

Select using the left adjuster wheel on the steering wheel

Turn the adjuster wheel to call up the required function.

Press the adjuster wheel to select marked items and confirm commands. Press to operate the stop watch or restart measurement and calculation.

Trip computer ⇨ 102.

Function areas

For each function area there is a main page (Main), which is selected at the top edge of the display:

- Audio,
- Navigation,
- Telephone,
- Trip computer.

See Infotainment manual for further information.

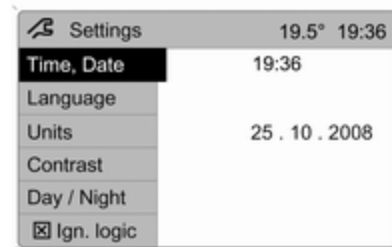
System settings

20013

The settings are accessed via the **Settings** menu. Press **Main** (not found on all Infotainment systems) on the Infotainment system, to call up main display. Press **Settings**. On Infotainment System CD 30, ensure no menu has been selected. The **Settings** menu is displayed.

The functions are displayed in the following order:

- **Time, Date**
- **Language**

- Units
- Contrast
- Day / Night
- Ignition logic

Setting date and time



20014

With the navigation system, date and time are set automatically upon receipt of a GPS satellite signal. If the displayed time does not match local time, it can be corrected manually or automatically by receiving an RDS time signal.

Some RDS transmitters do not send a correct time signal. In such cases, switch off automatic time synchronisation and set the time manually.

To set date and time manually, select menu item **Time, Date** from the **Settings** menu. The menu is displayed. Select the menu items required and make the desired setting.

To correct time with the help of RDS, select menu item **Synchron. clock automatical.** from the **Time, Date** menu. The box in front of **Synchron. clock automatical.** will be checked.

Language selection



20015

The display language for some functions can be selected. Select menu item **Language** from the **Settings** menu. The available languages are displayed.



20016

Select the desired language. Selections are indicated by a ► in front of the menu item.

In systems with voice output, when the language setting of the display is changed, the system will ask whether the announcement language should also be changed – see Infotainment manual.

Setting units of measure



20017

Select menu item **Units** from the **Settings** menu. The available units are displayed. Select the desired unit.

Selections are indicated by a ● in front of the menu item.

Adjusting contrast (Graphic-Info-Display)

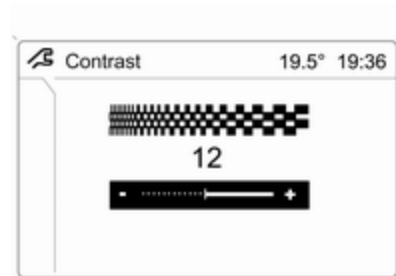

20018

Select menu item **Contrast** from the **Settings** menu. The menu is displayed. Confirm the required setting.

Setting display mode

The display can be adjusted to suit the lighting conditions:

Select menu item **Day / Night** from the **Settings** menu. The options are displayed.

Automatic; adapted based on vehicle lighting.

Always day design; black or coloured text on a light background.

Always night design; white or coloured text on a dark background.

Selections are indicated by a ● in front of the menu item.

Ignition logic

See Infotainment manual.

Vehicle messages

Warning chimes

When starting the engine or whilst driving

Only one warning chime will sound at a time.

The warning chime regarding unfastened seat belts has priority over any other warning chime.

- If seat belt is not fastened.
- When operating the turn and lane-change signals.
- When the vehicle is being driven and the electrical parking brake is applied ⇨ 143.
- When releasing the electrical parking brake without applying the foot brake ⇨ 90.
- If there is a fault in the braking system ⇨ 85.
- If the parking assist detects an object ⇨ 148.

- During automatic self-cleaning of the diesel particle filter ⇨ 129.
- In vehicles equipped with engine overspeed warning; when vehicle speed exceeds 120 km/h ⇨ 91.

When the vehicle is parked and/or the driver's door is opened

- When the key is in the ignition switch.
- With exterior lights on.

Tyre pressure

Check control

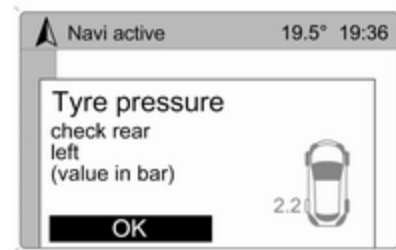

In vehicles with tyre pressure monitoring system, if low tyre pressures are detected, relevant information appears on the Info-display.

Reduce speed and check tyre pressure at the next opportunity.

Check tyre pressures ⇨ 182, ⇨ 212.



20022

If there is a considerable loss of pressure, a corresponding message appears indicating the relevant tyre.

Steer out of the flow of traffic as quickly as possible without endangering other vehicles. Stop and check the tyres. Mount the spare wheel ⇨ 190, ⇨ 193.

Tyre pressure monitoring system
⇨ 183.

Trip computer

Trip computer in Board-Info-Display

The trip computer provides information on driving data, which is continually recorded and evaluated electronically. Access trip computer vehicle data by pressing the **BC** button on the Infotainment system or the left adjuster wheel on the steering wheel.

Some of the functions appear on the display in an abbreviated form. Once a function has been selected, the subsequent rows of the trip computer function are displayed.

The functions are displayed in the following order:

- Instantaneous consumption
- Average consumption
- Effective consumption
- Average speed
- Distance travelled
- Range
- Stop watch

Board-Info-Display ↪ 92.

Instantaneous consumption

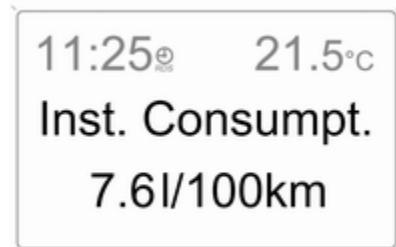

20023

Display of the instantaneous consumption.

Display changes depending on speed:

Display in l/h : below 13 km/h
 Display in : above 13 km/h
 l/100 km

Average consumption

Display of average consumption. The measurement can be reset at any time.

Effective consumption

Display of the amount of fuel consumed. The measurement can be reset at any time.

Average speed

Display of average speed. The measurement can be reset at any time.

Stoppages in the journey with the ignition off are not included in the calculations.

Distance travelled

Display of distance travelled. The measurement can be reset at any time.

Range

Range is calculated from current fuel tank content and instantaneous consumption. The display shows average values.

After refuelling, the range is updated automatically after a brief delay.

If the fuel in the tank allows less than 50 km of travel, the warning **Range** appears on the display.

If the fuel in the tank allows less than 30 km of travel, the warning **Refuel!** appears on the display.

Acknowledge the menu item ↪ 92.

Resetting trip computer information

Select the desired trip computer information and reset by pressing the left adjuster wheel on the steering wheel or the **OK** button on the Infotainment system.

Stop watch

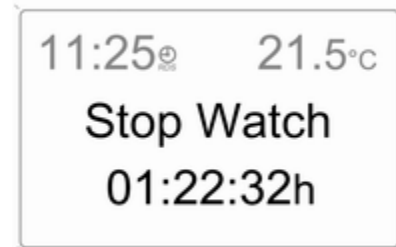

20024

Using the arrow buttons:

To start, press left arrow button to select menu item **Start** and press **OK** button to start/stop. To reset, press left arrow button to select menu item **Reset** and press **OK** button.

Using the left adjuster wheel on the steering wheel:

To start, select menu item **Start** and press to start/stop. To reset, select menu item **Reset** and press to confirm command.

Interruption of power supply

If the power supply has been interrupted or if the battery voltage has dropped too low, the values stored in the trip computer will be lost.

Trip computer in Graphic-Info-Display or Colour-Info-Display

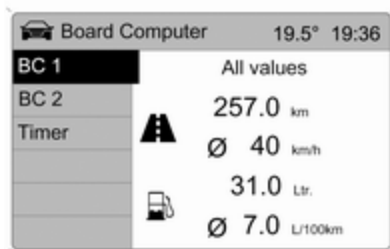

20027

The trip computers provide information on driving data, which is continually recorded and evaluated electronically. The trip computer main page provides information on range, average consumption and instantaneous consumption.

To display other trip computer data, press the **BC** button on the Infotainment system and select the trip computer menu in the display.

The information of the two trip computers can be reset separately, making it possible to display different trip distances.

Graphic-Info-Display,
Colour-Info-Display ↻ 94.

Range



20025

Range is calculated from current fuel tank content and instantaneous consumption. The display shows average values.

After refuelling, the range is updated automatically after a brief delay.



If the fuel in the tank allows less than 50 km of travel, the warning **Range** appears on the display.

If the fuel in the tank allows less than 30 km of travel, the warning **Refuell** appears on the display.

Acknowledge the menu item ↪ 94.

Instantaneous consumption

Display of the instantaneous consumption.

Display changes depending on speed:

Display in l/h : below 13 km/h
 Display in : above 13 km/h
 l/100 km

Distance travelled

Display of distance travelled. The measurement can be reset at any time.

Average speed

Display of average speed. The measurement can be reset at any time.

Stoppages in the journey with the ignition off are not included in the calculations.

Effective consumption

Display of the amount of fuel consumed. The measurement can be reset at any time.

Average consumption

Display of average consumption. The measurement can be reset at any time.

Resetting trip computer information



Select **BC 1** or **BC 2** from the trip computer menu.

Select the desired trip computer information and reset by pressing the left adjuster wheel on the steering wheel or the **OK** button on the Infotainment system.



To reset all information of a trip computer, select menu item **All values**. After resetting, "--" is displayed for the trip computer information selected. The recalculated values are displayed after a brief delay.

Stop watch

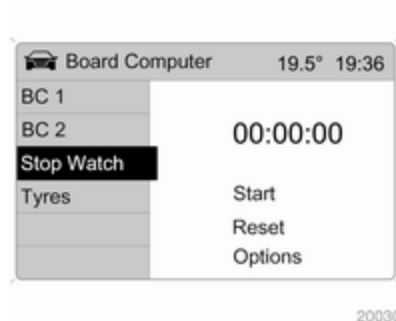

Select menu item **Timer** from the **Board Computer** menu. The **Timer** menu is displayed.

To start, select menu item **Start**. To reset, select menu item **Reset**.

The desired stop watch display can be selected from the **Options** menu:

Driving Time excl. Stops: The time the vehicle is in motion is recorded. Stationary time is not included.

Driving Time incl. Stops: The time the vehicle is in motion is recorded. The time the vehicle is stationary with the key in the ignition switch is included.

Travel Time: Measurement of the time from manual activation via **Start** to manual deactivation via **Reset**.

Interruption of power supply

If the power supply has been interrupted or if the battery voltage has dropped too low, the values stored in the trip computer will be lost.

Lighting

Exterior lighting	105
Light switch	105
Automatic light control	106
High beam	106
Headlight flash	106
Headlight range adjustment	106
Headlights when driving abroad	107
Daytime running lights	107
Hazard warning flashers	107
Turn and lane-change signals .	108
Front fog lights	108
Rear fog lights	109
Parking lights	109
Reversing lights	109
Misted light covers	109
Interior lighting	110
Instrument panel illumination control	110
Interior lights	110
Load compartment lighting	111
Reading lights	111
Sunvisor lights	112
Lighting features	112
Entry lighting	112



Exit lighting	112
Battery discharge protection	113

Exterior lighting

Light switch



Turn light switch:

- AUTO** : automatic light control:
Headlights are switched on and off automatically depending on external lighting conditions.
- 0** : off (or deactivation of automatic light control).
-  : sidelights
-  : headlights

Control indicator   90.

Tail lights

Tail lights illuminate together with low beam/high beam and sidelights.

Automatic light control



When the automatic light control function is switched on and the engine is running, low beam switches on automatically depending on outside light conditions.

For reasons of safety, the light switch should always remain in the **AUTO** position.

To ensure automatic light control functions properly, do not cover the light sensor on top of the instrument panel.

Driving abroad ⇨ 107.

Wiper activated lighting

With light switch in the **AUTO** position, when the windscreen wiper is operated for 8 cycles or more the exterior lights illuminate automatically.

High beam

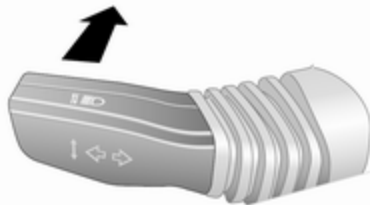

To switch from low to high beam, push lever.

To switch to low beam, pull lever back again.

Control indicator ⇨ ⇩ ⇨ 90.

Headlight flash

To activate the headlight flash, pull lever.

Headlight range adjustment

Manual headlight range adjustment ⇨



With low beam switched on, adapt headlight range to suit vehicle load. Correct adjustment of the headlight range reduces dazzle for other road users.

Vehicles without automatic level control system

Turn thumb wheel  to required position:

- 0 : front seats occupied
- 1 : all seats occupied
- 2 : all seats occupied and load compartment laden
- 3 : driver's seat occupied and load compartment laden

Vehicles with automatic level control system

Turn thumb wheel to required position:



- 0 : front seats occupied
- 1 : all seats occupied
- 1 : all seats occupied and load compartment laden
- 2 : driver's seat occupied and load compartment laden

Automatic level control  147.

Automatic headlight range adjustment

On vehicles with Xenon headlights, the headlight range is adjusted automatically based on vehicle load.

If control indicator  illuminates in the instrument cluster while driving, a fault has occurred. Have the cause of the fault remedied immediately by a workshop.

Control indicator  for Automatic headlight levelling system  90.

Headlights when driving abroad

The asymmetrical headlight beam extends visibility at the edge of the road on the passenger side.

However, when driving in countries where traffic drives on the opposite side of the road, have the headlights adjusted to prevent dazzling of oncoming traffic. Seek the assistance of a workshop.

Daytime running lights

Daytime running lights increase visibility of the vehicle during daylight.

They are switched on automatically when ignition is on.

Automatic light control  106.

Hazard warning flashers



Operated by pressing .

In the event of an accident with airbag deployment the hazard warning flashers are activated automatically.

Turn and lane-change signals



lever up : right turn signal
 lever down : left turn signal

If the lever is moved past the resistance point, the turn signal is switched on constantly.

When the steering wheel is turned back, the turn signal is automatically deactivated. This will not happen when making a minor steering manoeuvre such as lane changing.

For three flashes, e.g. when changing lanes, press the lever until resistance is felt and then release. Move the lever to the resistance point and hold for longer indication.

The volume of the turn signal audible warning is dependent upon vehicle speed.

Switch the turn signal off manually by moving the lever to its original position.

Control indicators ⇄ ⇄ 83.

Front fog lights



Operated by pressing #D. Control indicator #D ⇄ 90 illuminates in the instrument cluster when the front fog lights are switched on.

The front fog lights can only be switched on when both the ignition and low beam/high beam or sidelights are on.

Light switch in position **AUTO**: switching on front fog lights will switch on low beam and sidelights automatically.



Follow the regulations of the country in which you are driving when using front fog lights.

Rear fog lights



Operated by pressing .

Control indicator  91 illuminates in the instrument cluster when the rear fog light is switched on.

The rear fog light can only be switched on when the ignition is on and the light switch is in position , or the front fog lights are on and the light switch is in position .

Light switch in position **AUTO**: switching on rear fog light will switch on low beam and sidelights automatically.

The vehicle rear fog light is deactivated when towing.

Parking lights

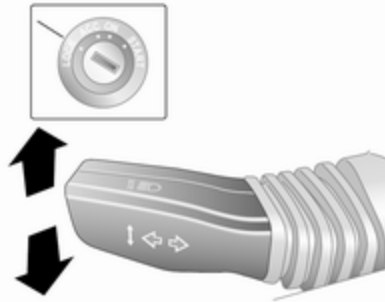

When the vehicle is parked, the parking lights on one side can be activated:

1. Set light switch to **O** or **AUTO**.
2. Switch off ignition.
3. Move turn signal lever all the way up (right parking lights) or down (left parking lights).

Confirmed by a signal tone and the corresponding turn signal control indicator.

To deactivate, switch on the ignition or move the turn signal lever in the opposite direction.

Reversing lights

The reversing lights come on when the ignition is on and reverse gear is selected.

Centre high-mounted brake light

Illuminates when the brakes are applied, acting as a third stop light, to supplement the brake lights.

Misted light covers

The inside of the light housing may mist up briefly in poor, wet and cold weather conditions, in heavy rain or after washing. The mist disappears quickly by itself; to help switch on the headlights.

Interior lighting

Instrument panel illumination control



Brightness of the following lights can be adjusted when the exterior lights are on:

- Instrument panel illumination
- Info-Display
- Illuminated switches and operation elements.

Turn thumb wheel  to the right or left until the desired brightness is obtained.

If driver's door is opened or  is pressed on the remote control, instrument panel illuminates automatically for 30 seconds until ignition switch is turned to position **ACC**.

Display mode ⇨ 94.

Interior lights

During entry and exit of the vehicle, the front and rear courtesy lights automatically switch on and then off after a delay.

Note

In the event of an accident with airbag deployment the courtesy lights are turned on automatically.

Front courtesy light

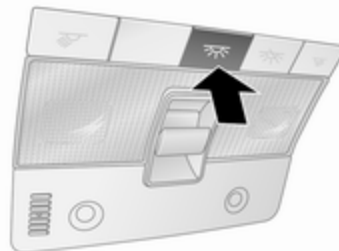

Front and rear reading lights and the load compartment lights function as courtesy lights and illuminate when the doors or the tailgate are opened.

If the doors or tailgate remain open, the lights stay illuminated for 10 minutes. Once all doors and the tailgate are closed, the courtesy lights dim gradually after 10 seconds.

By pressing  in the roof console, both the front and rear reading lights illuminate. Press again to turn off.

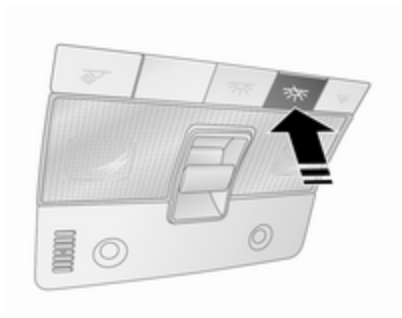

Courtesy lights can be turned off immediately by pressing ☀.

Ignition switch illumination

Illuminates when you open a door. Switch off immediately by pressing ☀ in the roof console.

Glovebox illumination

Illuminates when the glovebox is opened.

Load compartment lighting

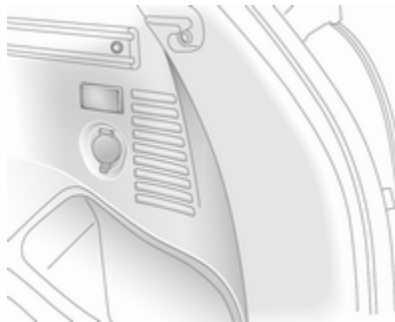

Illuminates when a door or the tailgate is opened.

Reading lights

Front reading lights

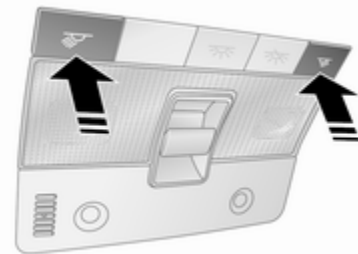

Operated by pressing ☀ and ☀.

Avoid using front reading lights while driving in the dark, as they can reduce driver visibility.

Rear reading lights



Left and right rear reading lights are individually operable. Press to activate and deactivate.

Sunvisor lights

Illuminates when the vanity mirror cover is opened ⇨ 33.

Lighting features

Entry lighting

Welcome lighting

Depending upon outside light conditions, when unlocking the vehicle with the remote control the hazard warning lights flash twice and the exterior and interior lights illuminate for 20 seconds. This function facilitates locating the vehicle when it is dark.

Exit lighting

The low beam and reversing lights illuminate for 30 seconds after the driver exits the vehicle and closes the door.

Switching on



1. Switch off ignition.
2. Remove ignition key.
3. Open driver's door.
4. Pull turn signal lever.
5. Close driver's door.

If the driver's door is not closed the lights switch off after two minutes.

Exit lighting can be deactivated by inserting the key in the ignition switch or by pulling the turn signal lever again while the driver's door is open.

Battery discharge protection

To prevent the battery from becoming discharged, the exterior lights turn off automatically 10 minutes after the ignition is switched off.

Battery discharge protection will not work if the lights are turned on 10 minutes after the ignition has been switched off; the key cannot be removed from the ignition switch until the battery is recharged.

Climate control

Climate control systems	114
Heating and ventilation system	114
Air conditioning system	115
Electronic climate control system	116
Air vents	119
Adjustable air vents	119
Fixed air vents	120
Maintenance	120
Air intake	120
Pollen filter	120
Air conditioning regular operation	121
Service	121

Climate control systems

Heating and ventilation system



Controls for:

- Temperature
- Air distribution
- Fan speed
- Demisting and defrosting

Heated rear window  ⇨ 32.

Heated seats  ⇨ 40.

Temperature

red : warm

blue : cold

Heating will not be fully effective until the engine has reached normal operating temperature.

Air distribution

 : to head area via adjustable air vents

 : to head area via adjustable air vents and to foot wells

 : to foot wells and to windscreen

 : to windscreen, front door windows and foot wells

 : to windscreen, front door windows and head area via adjustable air vents

All combinations are possible.

Fan speed



Adjust the air flow by switching the fan to the desired speed.

 : off

1 : minimum speed

4 : maximum speed



Demisting and defrosting

- Set the air distribution switch to  or 
- Set temperature control to warmest level
- Set fan to highest level
- Close centre air vents
- Open side air vents and direct them towards the door windows

Heated rear window  ↪ 32.

Air conditioning system

In addition to the heating and ventilation system, the air conditioning system has controls for:

-  : cooling
-  : air recirculation
-  : demisting and defrosting

Heated seats  ↪ 40.

Cooling

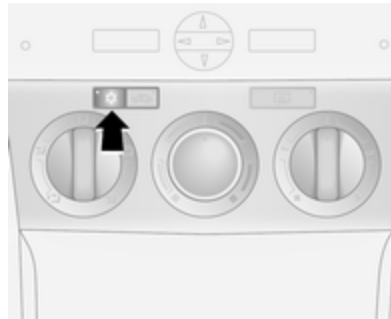

Press  to switch on cooling. Activation is indicated by illumination of the LED in the button. Cooling is only functional when the engine is running and climate control fan is switched on.

Press  again to switch off cooling.

The air conditioning system cools and dehumidifies (dries) as soon as the outside temperature is slightly above freezing point. Therefore condensation may form and drip from under the vehicle.

If no cooling or drying is required, switch the cooling system off to save fuel.

Activated cooling may inhibit autostops. Stop-start system ↪ 126.

Air recirculation system

Press  to activate air recirculation mode. Activation is indicated by illumination of the LED in the button.

Press  again to deactivate recirculation mode.

Warning



The exchange of fresh air is reduced in air recirculation mode. In operation without cooling the air humidity increases, so the windows may mist up from inside. The quality of the passenger compartment air deteriorates, which may cause the vehicle occupants to feel drowsy.

In warm and very humid ambient air conditions, the windscreen might mist up from outside, when cold air is

directed towards it. If windscreen mists up from outside, activate windscreen wiper and deactivate .



Maximum cooling





Briefly open the windows and sunroof so that hot air can disperse quickly.

- Press  to activate air conditioning.
- Press  to activate air recirculation.
- Set air distribution switch to .
- Set temperature control to coldest level.
- Set fan to highest level.
- Open all vents.

Demisting and defrosting



- Set the air distribution switch to  or .
- Set temperature control to warmest level.
- Set fan to highest level.
- Close centre air vents.
- Open side air vents and direct them towards the door windows.
- Switch on heated rear window 
↪ 32.

Air conditioning  and air recirculation  are switched on automatically to improve defrosting efficiency when position  or  is selected.

Activated demisting and defrosting may inhibit autostops. Stop-start system ↪ 126.

Electronic climate control system

The dual zone climate control allows different climatization temperatures for driver and front passenger side.

In automatic mode, temperature, fan speed and air distribution are regulated automatically.



Controls for:

- Temperature on driver side
- Air distribution
- Fan speed
- Temperature on front passenger side

AUTO : Automatic mode

 : Automatic air recirculation

 : Demisting and defrosting

Cooling **A/C**, Air recirculation 
 ⇨ 115.

Note

Do not cover the interior temperature sensor (located beside the fan switch) or the sunlight sensor

(located in front of the windscreen defroster vents) as this could cause the system to malfunction.

Heated rear window  ⇨ 32,
 Heated seats  ⇨ 40.

Automatic mode AUTO

Basic setting for maximum comfort:



- Press **AUTO**; cooling **A/C** is switched on and the air distribution and fan speed are regulated automatically.

- Open all air vents.
- Set the preselected temperatures for driver's side and front passenger's side using the left and right rotary knobs.

Note

All air vents are actuated automatically in Automatic mode. The air vents should therefore always be open.

Temperature preselection

Recommended comfort setting is 22 °C. Intermediate settings are possible.

Press **SYNC** to automatically adjust front passenger's side temperature to match current driver's side temperature. Activation is indicated by illumination of the LED in the button.

If temperature settings are different between driver's side and front passenger's side, LED in **SYNC** button extinguishes.

Note

If **A/C** is switched on, reducing the set cabin temperature can cause the engine to restart from an Autostop or inhibit an Autostop.

Stop-start system ⇨ 126.

Manual settings

Climate control system settings can be changed by pressing **A/C** or by adjusting the fan speed or air distribution switch. Changing a setting will deactivate Automatic mode.

To return to Automatic mode: Press **AUTO**.

Cooling **A/C** ⇨ 115.





Fan speed

To deactivate Automatic mode, change fan speed manually or turn fan to position off.

To return to Automatic mode: Switch on fan and press **AUTO**.

Air distribution

Press appropriate button for desired adjustment. Activation is indicated by illumination of the LED in the button.

-  : to head area via adjustable air vents
-  : to head area via adjustable air vents and to foot wells
-  : to foot wells and to windscreen
-  : to windscreen, front door windows and foot wells
-  : to windscreen, front door windows and head area via adjustable air vents

All combinations are possible.

To return to Automatic mode: Press **AUTO**.

Automatic air recirculation

The automatic air recirculation system has an air quality sensor which switches on automatically if harmful ambient gases are detected.



Operated by pressing . Activation is indicated by illumination of the LED in the button.

The automatic air recirculation system is only operational if the engine is running.

⚠ Warning

The exchange of fresh air is reduced in air recirculation mode. In operation without cooling the air humidity increases, so the windows may mist up from inside. The quality of the passenger compartment air deteriorates, which may cause the vehicle occupants to feel drowsy.

Demisting and defrosting



- Press . Activation is indicated by illumination of the LED in the button.
- Set fan to the desired speed. Air recirculation mode is automatically switched off. Cooling **A/C** switches on.
- Switch on heated rear window **R**.

To switch off window demisting and defrosting, press again, press **AUTO**, adjust fan speed or air distribution switch.

Activated demisting and defrosting may inhibit autostops. Stop-start system ⇨ 126.

Air vents

Adjustable air vents

At least one air vent must be open while the cooling **A/C** is on.

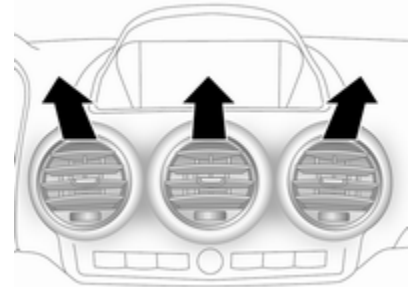

To open and close the vents, turn the horizontal adjuster wheel to the left or right.

Open air vents when air distribution switch is set to or .

The air supply is increased by switching on the fan.

Control the air temperature at the side air vents by adjusting the temperature control switch.



Direct the flow of air by tilting and swivelling the slats.

⚠ Warning

Do not attach any objects to the slats of the air vents. Risk of damage and injury in case of an accident.

Fixed air vents

Additional air vents are located beneath the windscreen, door windows and in the front and rear foot wells.

The area underneath the front seats must be kept clear, to allow air flow to the rear passenger foot well.

Maintenance

Air intake

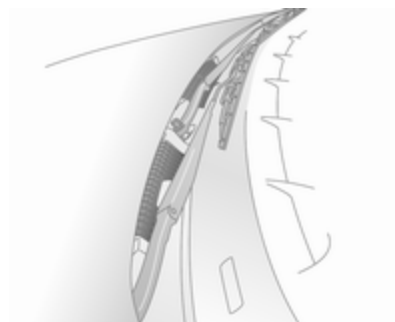

The air intakes in front of the windscreen in the engine compartment must be kept clear to allow air intake. Remove any leaves, dirt or snow.

Pollen filter

Cabin air filtration

A particle filter cleans the cabin air from dust, soot, pollen and spores.

Active carbon filter

In addition to the particle filter the active carbon filter reduces odours.

Air conditioning regular operation

In order to ensure continuously efficient performance, cooling must be operated for a few minutes once a week, irrespective of the weather and time of year. Operation with cooling is not possible when outside temperature is too low.

Service

For optimal cooling performance, it is recommended to annually check the climate control system, starting three years after initial vehicle registration, including:

- functionality and pressure test
- heating functionality
- leakage check
- check of drive belts

- cleaning of condenser and evaporator drainage
- performance check

Note

Refrigerant R-134a contains fluorinated greenhouse gases.

Driving and operating

Driving hints	122
Driving economically	122
Control of the vehicle	123
Steering	124
Starting and operating	124
New vehicle running-in	124
Ignition switch positions	125
Starting the engine	125
Overrun cut-off	126
Stop-start system	126
Parking	128
Engine exhaust	129
Diesel particle filter	129
Catalytic converter	130
AdBlue	131
Automatic transmission	136
Transmission display	136
Selector lever	136
Sport mode	137
Manual mode	138
Electronic driving programmes	138
Fault	138
Interruption of power supply	139

Manual transmission	139
Drive systems	140
All-wheel drive	140
Brakes	142
Antilock brake system	142
Parking brake	143
Brake assist	144
Hill start assist	144
Ride control systems	145
Electronic Stability Control	145
Descent control system	146
Automatic level control	147
Driver assistance systems	147
Cruise control	147
Parking assist	148
Fuel	150
Fuel for diesel engines	150
Refuelling	150
Fuel consumption - CO ₂ -Emissions	151
Trailer hitch	152
General information	152
Driving characteristics and towing tips	152
Trailer towing	153
Towing equipment	153
Trailer stability assist	155

Driving hints

Driving economically

Fuel economy mode

Fuel economy mode is a function that optimises fuel consumption. It affects, e.g., engine power and torque, acceleration and gear shift indication.

Manual transmission

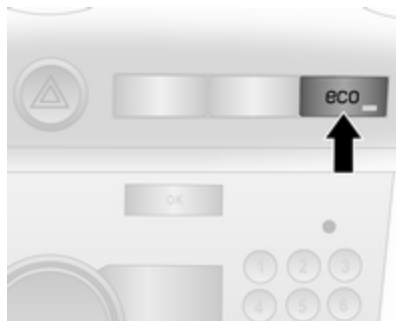

Activation

Press **ECO** on the instrument panel; LED in the button illuminates to indicate activation.

Deactivation

Press **ECO** again; LED in the button extinguishes.

Stop-start system ⇨ 126.

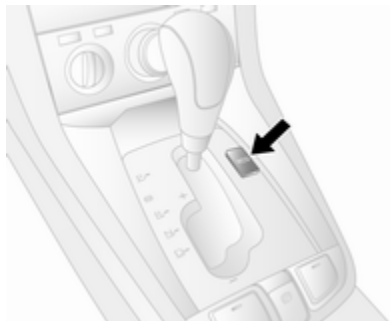
Automatic transmission

Activate fuel economy mode to allow the transmission to adapt gearshift patterns, improving the vehicle's fuel economy.

Activation

In automatic mode, press **ECO**.



Control indicator **ECO** illuminates in the instrument cluster ⇨ 89.

The settings of certain electronic systems are adapted to reduce fuel consumption:

- The engine reacts less quickly to the accelerator pedal.
- Automatic upshift points occur sooner and downshift points occur later.

- The transmission locks itself to the engine at cruising speeds, to improve efficiency and increase power and torque.
- The fuel supply is automatically cut-off more quickly during vehicle deceleration. Overrun cut-off ⇨ 126.

Do not use fuel economy mode whilst towing, e.g. a trailer.

Deactivation

Press **ECO** again; control indicator **ECO** extinguishes in the instrument cluster.

Control of the vehicle**Never coast with engine not running (except during Autostop)**

Many systems will not function in this situation (e.g. brake servo unit, power steering). Driving in this manner is a danger to yourself and others. All systems function during an Autostop, but there will be a controlled reduction in power steering assist and vehicle speed is reduced.

Stop-start system ⇨ 126.

Pedals

To ensure the pedal travel is uninhibited, there must be no mats in the area of the pedals.

Steering

Caution
Never leave the steering wheel on full lock when the vehicle is stationary, as this may damage the power steering pump.

If power steering assist is lost because the engine stops or due to a system malfunction, the vehicle can be steered but may require increased effort.

Electric power steering

Electric power steering does not have power steering fluid. Regular maintenance is not required.

Note

If the steering wheel is turned until it reaches the end of its travel, and is held in that position for an extended

period of time, power steering assist may be reduced. If used for an extended period of time, power steering assist may be reduced. Normal use of the power steering assist should return when the system cools down.

If power steering assist is lost due to a system malfunction, the vehicle can be steered but may require increased effort. Seek the assistance of a workshop.

Control indicator   86.

Starting and operating

New vehicle running-in

Do not brake unnecessarily hard for the first few journeys.

During the first drive, smoke may occur because of wax and oil evaporating off the exhaust system. Park the vehicle in the open for a while after the first drive and avoid inhaling the fumes.

During the running-in period fuel and engine oil consumption may be higher and the cleaning process of the diesel particle filter may take place more often. Autostop may be inhibited to allow for charging of the battery.

Diesel particle filter  129.

Ignition switch positions



- LOCK** : Ignition off
ACC : Steering wheel lock released, ignition off
ON : Ignition on, for diesel engine: preheating
START : Starting

Steering wheel lock

Remove key from ignition switch and turn steering wheel until it engages.

⚠ Danger

Never remove the key from ignition switch during driving as this will cause steering wheel lock.



Starting the engine



Manual transmission: operate clutch and brake pedals.

Automatic transmission: operate brake pedal and move selector lever to **P** or **N**.

Do not operate accelerator pedal.

Diesel engines: turn the key to position **ON** for preheating until control indicator  extinguishes  87.

Turn key briefly to position **START** and release. Key returns automatically to position **ON**.

Before restarting or to switch off the engine, turn key back to **LOCK**.

Start attempts should not last longer than 15 seconds. If engine does not start, wait 10 seconds before repeating starting procedure.

The increased engine speed automatically returns to normal idling speed as the engine temperature rises. Drive at a moderate speed, especially in cold weather, until normal engine operating temperatures have been reached.

During an Autostop, the engine can be started by depressing the clutch pedal.

Stop-start system  126.

Starting the vehicle at low temperatures

In extremely cold temperatures, i.e. below -20°C , it may be necessary to crank the engine for up to 30 seconds for it to start.

Turn key to position **START** and hold until engine starts. Start attempts should not last longer than 30 seconds. If engine does not start, wait 10 seconds before repeating starting procedure.

Ensure the engine oil is of the correct viscosity, the correct fuel is used, vehicle services are performed regularly and the battery is sufficiently charged.

Turbo engine warm-up

Upon start-up, engine available torque may be limited for a short time, especially when the engine temperature is cold. The limitation is to allow the lubrication system to fully protect the engine.

Overrun cut-off

The fuel supply is automatically cut-off during overrun, i.e. when the vehicle is driven with a gear engaged but accelerator is released.

Stop-start system

The stop-start system helps to save fuel and to reduce the exhaust emissions. When conditions allow, it switches off the engine as soon as the vehicle is at a low speed or at a standstill, e.g. at a traffic light or in a traffic jam. It starts the engine automatically as soon as the clutch is depressed. A vehicle battery sensor ensures that an Autostop is only performed if the vehicle battery is sufficiently charged for a restart.

Activation

The stop-start system is available as soon as the engine is started, the vehicle starts-off and the conditions as stated below in this section are fulfilled.

Deactivation



Deactivate the stop-start system manually by pressing **ECO**. The deactivation is indicated when the LED in the button extinguishes.

Fuel economy mode ↻ 122.

Autostop

If the vehicle is at a low speed or at a standstill, activate an Autostop as follows:

- Depress the clutch pedal
- set the lever to neutral
- release the clutch pedal

The engine will be switched off while the ignition stays on.

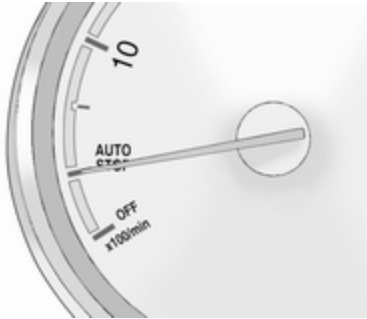

An Autostop is indicated by the needle at the **AUTOSTOP** position in the tachometer.

During an Autostop, the heating, power steering and brake performance will be maintained.

Air conditioning system may or may not inhibit the stop-start system according to the cooling performance.

Caution

The steering assist can be reduced during an Autostop.

Conditions for an Autostop

The stop-start system checks if each of the following conditions is fulfilled.

- The stop-start system is not manually deactivated
- the bonnet is fully closed
- the driver's door is closed or the driver's seat belt is fastened
- the vehicle battery is sufficiently charged and in good condition
- the engine is warmed up
- the engine coolant temperature is not too high or low
- the engine exhaust temperature is not too high, e.g. after driving with high engine load
- the ambient temperature is not too low
- the defrosting function is not activated
- the climate control system does not inhibit an engine stop
- the brake vacuum is sufficient

- the self-cleaning function of the diesel particle filter is not active
- the vehicle has moved since the last Autostop

Otherwise an Autostop will be inhibited.

Certain settings of the climate control system may inhibit an Autostop. See "Climate control" chapter for more details ↻ 116.

Immediately after motorway driving an Autostop may be inhibited.

New vehicle running-in ↻ 124.

Vehicle battery discharge protection

To ensure reliable engine restarts, several vehicle battery discharge protection features are implemented as part of the stop-start system.

Restart of the engine by the driver

Depress the clutch pedal to restart the engine.

The engine start is indicated by the needle at the idle speed position in the tachometer.

If the selector lever is shifted out of neutral before depressing the clutch first, control indicator  illuminates.

Control indicator  ↷ 90.

Restart of the engine by the stop-start system

The selector lever must be in neutral to enable an automatic restart.

If one of the following conditions occurs during an Autostop, the engine will be restarted automatically by the stop-start system.

- The stop-start system is manually deactivated
- the bonnet is opened
- the driver's seat belt is unfastened and the driver's door is opened
- the engine temperature is too low
- the charging level of the vehicle battery is below a defined level
- the brake vacuum is not sufficient
- the vehicle is driven at least at walking speed
- the defrosting function is activated

- the climate control system requests an engine start
- the air conditioning is manually switched on

If an electrical accessory, e.g. a portable CD player, is connected to the power outlet, a brief power drop during restart might be noticeable.

Parking

Warning

- Do not park the vehicle on an easily ignitable surface. The high temperature of the exhaust system could ignite the surface.
- Always apply the electrical parking brake.
Pull switch .

The electric parking brake is applied when control indicator  illuminates ↷ 85.

For maximum force, e.g. parking with a trailer or on inclines, pull switch  twice.

- Switch off the engine.
- If the vehicle is on a level surface or uphill slope, engage first gear or move the selector lever to **P** before removing the ignition key. On an uphill slope, turn the front wheels away from the kerb.

If the vehicle is on a downhill slope, engage reverse gear or move the selector lever to **P** before removing the ignition key. Turn the front wheels towards the kerb.

- Close windows and sunroof.
- Turn the ignition key to position **LOCK**, push key into ignition switch and remove.

For vehicles with automatic transmission, depress foot brake and shift into **P** before pushing key into ignition switch and removing.

Turn the steering wheel until the steering wheel lock is felt to engage.

- Lock the vehicle by pressing  on the radio remote control ⇨ 22.
Activate the anti-theft alarm system ⇨ 26.

Engine exhaust

Danger

Engine exhaust gases contain poisonous carbon monoxide, which is colourless and odourless and could be fatal if inhaled.

If exhaust gases enter the interior of the vehicle, open the windows. Have the cause of the fault rectified by a workshop.

Avoid driving with an open load compartment, otherwise exhaust gases could enter the vehicle.

Malfunction indicator light ⇨ 84.



Diesel particle filter

The diesel particle filter system filters harmful soot particles out of the exhaust gases. The system includes a self-cleaning function that runs automatically during driving without any notification.

The filter is cleaned by periodically burning off the soot particles at high temperature. This process takes place automatically under set driving conditions and may take more than 15 minutes. Autostop is not available and fuel consumption may be higher during this period. The emission of smells and smoke during this process is normal.



Under certain driving conditions, e.g. short distances, the system cannot clean itself automatically.

If cleaning of the filter is required and previous driving conditions did not enable automatic cleaning, it will be indicated by control indicator   88.

 illuminates, accompanied by a warning chime, when diesel particle filter is full. Start cleaning process as soon as possible.

 flashes when diesel particle filter has reached the maximum filling level. Start cleaning process immediately to avoid damage to the engine. A warning chime sounds every 3 minutes until the cleaning process is complete.

Cleaning process

To activate the cleaning process, continue driving, keeping engine speed above 2000 revolutions per minute. Shift down if necessary. Diesel particle filter cleaning is then started.

If control indicator  illuminates additionally in the instrument cluster when the engine is running, there may be a fault in the diesel particle

filter  84. Cleaning is not possible, seek the assistance of a workshop immediately.

Caution

If the cleaning process is interrupted, there is a risk of provoking severe engine damage.

Cleaning takes place quickest at high engine speeds and loads.

Do not switch off the engine until the cleaning process is complete. This is indicated by the extinguished control indicator .

Catalytic converter

The catalytic converter reduces the amount of harmful substances in the exhaust gases.

Caution

Fuel grades other than those listed  207 could damage the catalytic converter or electronic components.

Unburnt fuel will overheat and damage the catalytic converter. Therefore avoid excessive use of the starter, running the fuel tank dry and starting the engine by pushing or towing.

In the event of misfiring, uneven engine running, a reduction in engine performance or other unusual problems, have the cause of the fault rectified by a workshop as soon as possible. In an emergency, driving can be continued for a short period, keeping vehicle speed and engine speed low.

Malfunction indicator light  84.

AdBlue

General information

The selective catalytic reduction (BlueInjection) is a method to substantially reduce the nitrogen oxides in the exhaust emission. This is achieved by injecting a Diesel Exhaust Fluid (DEF) into the exhaust system.

The designation of this fluid is AdBlue®. It is a non-toxic, non-flammable, colourless and odourless fluid which consists of 32% urea and 68% water.

Note

AdBlue® is a registered trademark of the Verband der Automobilindustrie e.V. (VDA).

Warning

Avoid contact of your eyes or skin with AdBlue.

In case of eye or skin contact, rinse off with water.

Caution

Avoid contact of the paintwork with AdBlue.

In case of contact, rinse off with water.

AdBlue freezes at a temperature of approx. -11 °C. As the vehicle is equipped with an AdBlue pre-heater, the emissions reduction at low temperatures is ensured. The AdBlue pre-heater works automatically.

The typical AdBlue consumption is approx. two litres per 1000 km, but can also be higher depending on driving behaviour (e.g. high load or towing).

Level warnings



If the AdBlue level falls below a certain value, a level warning (e.g. "AdBlue Range: 2400 km") will be shown in the Driver Information Centre  91, located in the centre of the instrument cluster.

Refill the tank with a volume of at least 10 litres of AdBlue as soon as possible. Refer to "**Refilling AdBlue**" below.

Driving is possible without any restrictions.

If AdBlue is not refilled within a certain distance, further level warnings are shown in the Driver Information Centre, depending on the current AdBlue level.

Subsequent requests to refill AdBlue and finally the announcement that an engine restart will be prevented are displayed in the Driver Information Centre.

Note

These restrictions are a legal requirement.



At an AdBlue range of 900 km, the following warning messages are alternately displayed in the Driver Information Centre:

- **AdBlue Low Refill Now**
- **Engine Restart Prevented in 900 km**

Additionally, control indicator  flashes continuously.

Engine restarts prevented



Before the prevention of an engine restart, the following warning messages are alternately displayed in the Driver Information Centre:

- **AdBlue Empty Refill Now**
- **Engine Will Not Restart**

These messages indicate that after switching off the ignition, an engine restart will be prohibited.

Additionally, control indicator  flashes continuously.

After the prevention of an engine start, a warning message (e.g. "Refill AdBlue To Start Vehicle") is displayed in the Driver Information Centre reminding the driver that AdBlue level is insufficient.

To allow the engine to be restarted, the tank should be filled with at least 10 litres of AdBlue.

High emission warnings

If the exhaust emission rises above a certain value, warnings similar to the range warnings as described above will be displayed in the Driver Information Centre.

Requests to have the exhaust system checked and finally the announcement that an engine restart will be prevented are displayed in the Driver Information Centre.

Note

These restrictions are a legal requirement.

Seek the assistance of a workshop as soon as possible.

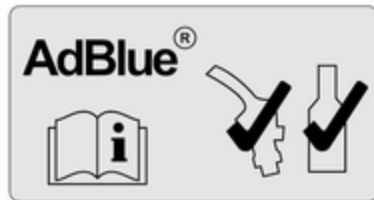
Refilling AdBlue**Caution**

Only use AdBlue that complies with European standards DIN 70 070 and ISO 22241-1.
Do not use additives.

Do not dilute AdBlue.

Otherwise the selective catalytic reduction system could be damaged.

Note

If AdBlue must be refilled at very low temperatures, the refilling of AdBlue may not be detected by the system. In this case, park the vehicle in a space with a higher ambient temperature until AdBlue is liquefied.

Note

If engine starting is prohibited due to low AdBlue level, we recommend refilling the tank completely or with a volume of at least ten litres of AdBlue (depending on AdBlue consumption).

Avoid minor top-ups (e.g. less than five litres), otherwise the system may not detect a refill.

Note

When unscrewing the protective cap from the filler neck, ammonia fumes may emerge. Do not inhale as the fumes have a pungent smell. The fumes are not harmful by inhalation.

The vehicle must be parked on a level surface.

The filler neck for AdBlue is located at the rear bumper on the left-hand side of the vehicle.

⚠ Danger

Vehicles with stop-start system:
The engine must be switched off and the ignition key removed, to avoid risk of engine being restarted automatically by the system.

Capacities ⇨ 211.

Filling station

⚠ Danger

Follow the operating and safety instructions of the filling station when refilling AdBlue.

1. Switch off engine and remove key from ignition switch.
2. Disengage the cover using a suitable screwdriver and remove.



3. Unscrew protective cap anticlockwise from the filler neck.

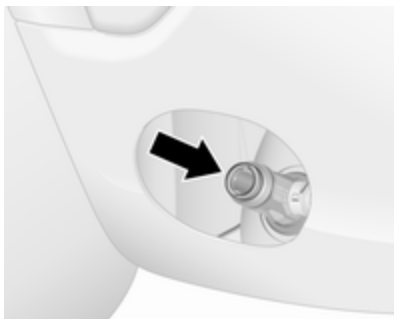

4. Fully insert the pump nozzle into the filler neck and switch it on.
5. When refilling is complete, mount the protective cap and turn clockwise until it engages.
6. Replace the cover by inserting the right side first.

AdBlue canister

Note

Only use the designated AdBlue canisters for refilling, to prevent a topping-up of too much AdBlue. Additionally, the fumes in the tank are captured in the canister and do not emerge.

Note

Since AdBlue has a limited durability, check the date of expiry before refilling.

1. Switch off engine and remove key from ignition switch.
2. Disengage the cover using a suitable screwdriver and remove.



3. Unscrew protective cap anticlockwise from the filler neck.

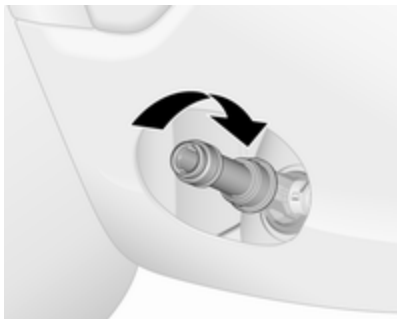

4. Attach the adapter (located in glovebox) to the filler neck.
5. Open AdBlue canister.
6. Mount one end of the hose on the canister and screw the other end on the filler neck adapter.
7. Lift the canister until it is empty.
8. Unscrew the hose from the filler neck adapter.
9. Remove the adapter and return to its container in the glovebox.
10. Mount the protective cap and turn clockwise until it engages.
11. Replace the cover.

Note

Dispose of AdBlue canister and hose according to environmental requirements.

Note

If an AdBlue refill is not detected, drive continuously for 10 minutes, keeping vehicle speed above 20 km/h.

If the AdBlue refill is detected successfully, AdBlue level warnings will disappear.

If the AdBlue refill is not detected some time after running the engine, seek the assistance of a workshop.

Note

If less than 10 litres of AdBlue have been refilled during the last 2 years, the remaining fluid should be exchanged since AdBlue has a limited durability. Seek the assistance of a workshop.

Disregard could lead to damage to the selective catalytic reduction system.

Filler cap

Only use genuine filler caps. AdBlue tank has a special filler cap.

Fault

If the system detects an operating fault, control indicator  illuminates together with a warning chime. Seek the assistance of a workshop immediately.

A corresponding message may appear in the Driver Information Centre  91.

Automatic transmission

The automatic transmission permits automatic gearshifting (automatic mode) or manual gearshifting (manual mode).

Transmission display

The transmission display is shown in the Driver Information Centre ↗ 91, located in the centre of the instrument cluster.

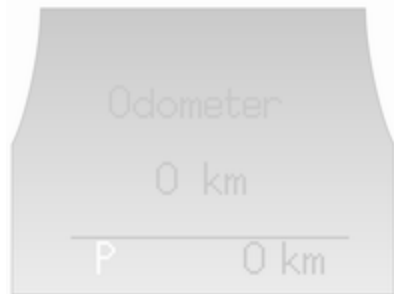

The mode or selected gear is shown in the transmission display.

- P** : park position
- R** : reverse gear
- N** : neutral
- D** : drive position (automatic mode)
- 1-6 : selected gear in manual mode

Selector lever



- P** : park position, wheels are locked, engage only when the vehicle is stationary and the electrical parking brake is applied
- R** : reverse gear, engage only when vehicle is stationary

- N** : neutral or idle
- D** : drive position (automatic mode with all gears)

The selector lever is locked in position **P** and **N** and can only be moved when the ignition is on and the foot brake is applied.

To engage **P** or **R**, push the release button.

Never shift to **P** or **R** while the vehicle is moving.

The engine can only be started with lever in position **P** or **N**. Depress foot brake or apply electrical parking brake before starting.

Do not accelerate while engaging a gear. Never depress the accelerator pedal and brake pedal at the same time.

When a gear is engaged, the vehicle slowly begins to creep when the foot brake is released.

Engine braking

To utilise the engine braking effect, select a lower gear in good time when driving downhill - see Manual mode.

Use of the engine braking effect, as opposed to the use of the foot brake when driving downhill, can extend the life of the brakes.

Rocking the vehicle

Rocking the vehicle is only permissible if the vehicle is stuck in water, ice, sand, mud, snow or a dip. Move the selector lever between **D** and **R** in a repeat pattern while applying light pressure to the accelerator pedal when the vehicle is in gear. Do not race the engine and avoid sudden acceleration.

If the vehicle cannot be released after rocking the vehicle several times, your vehicle may need to be towed
↗ 196.

Parking

Apply the electrical parking brake and engage **P**.

The ignition key can only be removed when the selector lever is in position **P**.

Sport mode

Suspension and steering become more direct and provide better contact with the road surface. The engine reacts more quickly to accelerator pedal movements. Automatic gear changing is also more responsive.

Sport mode can reduce the vehicle's fuel economy. Use normal mode whenever possible.

Note

Sport mode may be unavailable if the charging level of the vehicle battery is too low.

Activation

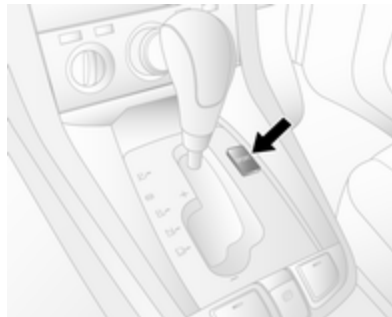

Press **SPORT** to switch on Sport mode.



Control indicator **SPORT** illuminates in the instrument cluster ↗ 86.

Deactivation

Press **SPORT** again to return to normal mode. Control indicator **SPORT** extinguishes.

Manual mode



Move selector lever out of position **D** towards the left and then forwards or backwards.

+ : Shift to a higher gear.

- : Shift to a lower gear.

Tip selector lever in the appropriate direction. It then returns to the centre position.

Gearshifting in manual mode can be achieved whilst accelerating. If the engine speed is too low, the transmission will automatically shift to a lower gear, even in manual mode, to prevent the engine from stalling.

If a higher gear is selected when vehicle speed is too low, or a lower gear when vehicle speed is too high, the shift is not executed.

In manual mode, no automatic shifting to a higher gear takes place at high engine revolutions.

Gears can be skipped by moving the selector lever repeatedly at short intervals.

After stopping, 1st gear is automatically selected. When starting on slippery surfaces, tip selector lever forwards to engage 2nd gear.

To move back to position **D**, move selector lever back to the right.

Electronic driving programmes

- Following a cold start, the operating temperature programme increases engine speed to quickly bring the catalytic converter to the required temperature.

Kickdown

In both automatic and manual modes, if the accelerator pedal is pressed down completely the transmission shifts to a lower gear depending on engine speed. Full engine power is available for acceleration.

Fuel economy mode ⇨ 122.

Fault

In the event of a fault in the automatic transmission, control indicator  illuminates in the instrument cluster ⇨ 84. Automatic shifting may be much harsher than normal or, in the case of a serious fault, cancelled altogether. Have the cause of the fault remedied by a workshop.

If control indicator  illuminates in the instrument cluster when the engine is running, this may indicate a fault in the transmission electronics ⇨ 84. The electronics switch to the emergency running programme, fuel consumption may increase and the driveability of the vehicle may be affected. Seek the assistance of a workshop.

Interruption of power supply

The clutch is not disengaged if the vehicle battery is discharged and a gear has been selected. The vehicle cannot move. The selector lever cannot be moved out of position **P** or **N**.

If the battery is discharged, start the vehicle using jump leads ⇨ 194.

If the battery is not the cause of the fault, release the selector lever:

1. Switch off ignition and remove the key.
2. Depress and hold foot brake.

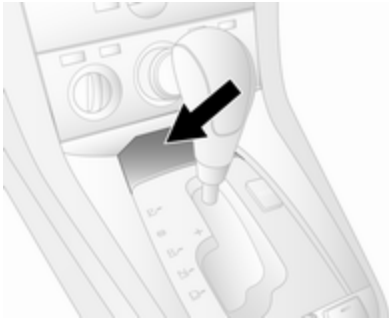

3. Remove trim cover.

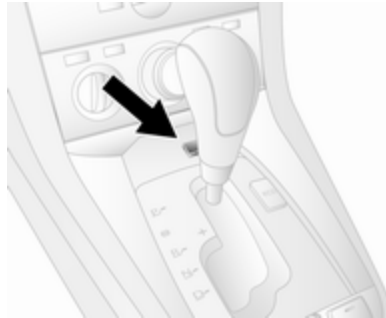

4. Press and hold shift lock release button.
5. Shift to neutral (**N**).
6. Replace trim cover.
7. Start engine and shift to chosen gear.

Have the cause of the power supply interruption remedied by a workshop.

Manual transmission



To engage reverse, with the vehicle stationary, wait 3 seconds after depressing clutch pedal and engage the gear.

If the gear does not engage, set the lever to neutral, release the clutch pedal and depress again; then repeat gear selection.

Do not slip the clutch unnecessarily. When operating, depress the clutch pedal completely. Do not use the pedal as a foot rest.

Caution

It is not advisable to drive with the hand resting on the selector lever.

Fuel economy mode ⇨ 122.



Drive systems**All-wheel drive**

All-wheel drive is an active-on-demand system that engages automatically, with no action required by the driver. Depending on the driving environment, the vehicle switches between two-wheel drive and four-wheel drive, to give the vehicle more traction and stability when necessary.

If the front wheels begin to slip, the rear wheels will automatically begin to drive the vehicle as required. More torque is transferred to the wheels that have the most traction, so the vehicle has optimum grip at all times. There may be a slight engagement noise during hard use.

As well as enabling the vehicle to be driven off-road, this system also enables the vehicle to be driven on normal roads without incurring excessive tyre and drivetrain wear or causing poor control.

Ensure tyres (including the spare) are inflated to the correct pressure ⇨ 212 and are suitable for the prevailing road conditions. For optimum system performance, the vehicle's tyres should not have varying degrees of wear.

If control indicator  flashes in the instrument cluster during driving, All-wheel drive is temporarily disabled. If  flashes continuously, there is a fault in the system; seek the assistance of a workshop.

All-wheel drive control indicator  ⇨ 86.

On-road driving

The increased traction of All-wheel drive vehicles offers greater driving control in adverse road conditions, particularly heavy snow and ice. However, All-wheel drive vehicles are not "skid-proof" and do not decrease stopping distances.

All-wheel drive vehicles have a higher centre of gravity than conventional vehicles. Always approach curves at an appropriate driving speed. Do not attempt to go as fast through turns as

you might in a conventional vehicle. Strong crosswinds can affect the normal steering of the vehicle. Drive slower under strong crosswind conditions.

Off-road driving

- Avoid protruding objects (such as rocks or tree stumps) that may damage the underbody and tyres of your vehicle.
- Test the brakes after operating in mud, to clear excess mud from the braking surfaces.
- Grip the steering wheel when travelling over rough terrain. Terrain conditions can cause rapid and unexpected movement in the steering.

The ground clearance, ramp angle, angle of approach and departure and wading depth need to be considered, especially in hilly conditions and when wading, to prevent the vehicle becoming stuck and possibly damaged.

Vehicle dimensions ⇨ 209.

Towing the vehicle ⇨ 196.

Driving through water

Do not exceed the maximum wading depth ⇨ 209.

Check the depth of water: choose the lowest entry and departure angles before entering. Maintain a steady engine speed, to help prevent water from entering the exhaust system, but do not exceed 5 km/h, to avoid splashing the water.

Drive with the flow wherever possible, not against it. If you have to drive against the flow, try to drive at an angle to it, so that the leading corner of the vehicle will help deflect water from the engine compartment. Avoid splashing the water - if the ignition system becomes wet, the engine may stall.

Avoid water entering the air intake system ⇨ 120. If water enters the air intake system, engine seizure with severe costly damage may result.

Test the brakes after leaving the water - wet brakes are less effective than dry ones. Perform the service operations for wading, involving checks for water contamination, at the earliest opportunity.

Service checks after wading

Check for the ingress of water into the following:

- Brake fluid reservoir
- Air cleaner element
- Engine
- Transmission
- Axles
- Interior of vehicle

Renew any lubricating oil or hydraulic fluid that has a milky appearance, indicating contamination with water.

Cleaning

Clean the vehicle thoroughly and as soon as possible after driving off-road.

Do not let mud remain dry on any part of the vehicle as it becomes abrasive and can damage paint, glass, seals, bearings and brake components. If left to build up, mud can seriously affect the airflow through and over mechanical components and cause localised overheating and failure of parts, especially in the engine compartment.

Ensure the radiator core and the area between the radiator and intercooler/oil cooler (where installed) is cleaned, to maintain proper cooling air flow. Check the radiator and cooler cores for blockage (sand, silt etc.).

Check the tyre treads.

Clean and check the mechanical parts of the vehicle, particularly the following areas:

- Driveshafts, including sealing bellows
- Front brake calipers, pads and discs
- Front suspension
- Clutch fork sealing bellows
- Rear brake calipers, pads and discs
- Rear suspension
- Fuel tank and underguard
- Breathers, axles and fuel tank
- Load sensing valve
- Transfer box and underguard
- Engine oil pan and underguard

Observe the following:

- Do not spray high-pressure water directly at the vehicle seals
- The wheels must be removed to clean all mud and stones from the brake calipers and to check brake pad wear
- The areas on the upper side of the underguards must be cleared of stones, to prevent damage to the engine oil pan and the fuel tank

Brakes

The brake system comprises two independent brake circuits.

If a brake circuit fails, the vehicle can still be braked using the other brake circuit. However, braking effect is achieved only when the brake pedal is depressed firmly. Considerably more force is needed for this. The braking distance is extended. Seek the assistance of a workshop before continuing your journey.

When the engine is not running, the support of the brake servo unit disappears once the brake pedal has been depressed once or twice. Braking effect is not reduced, but braking requires significantly greater force. It is especially important to bear this in mind when being towed.

Control indicator (D) ⇨ 85.

Antilock brake system

Antilock brake system (ABS) prevents the wheels from locking.

ABS starts to regulate brake pressure as soon as a wheel shows a tendency to lock. The vehicle remains steerable, even during hard braking.

ABS control is made apparent through a pulse in the brake pedal and the noise of the regulation process.

For optimum braking, keep the brake pedal fully depressed throughout the braking process, despite the fact that the pedal is pulsating. Do not reduce the pressure on the pedal.

After starting off, the system performs a self-test which may be audible.

Control indicator (ABS) ⇨ 85.

Fault

⚠ Warning

If there is a fault in the ABS, the wheels may be liable to lock due to braking that is heavier than normal. The advantages of ABS are no longer available. During

hard braking, the vehicle can no longer be steered and may swerve.

You can continue driving, provided you drive with care and anticipation. Have the cause of the fault remedied by a workshop.

Parking brake

Electrical parking brake

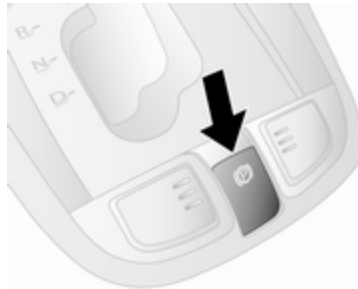

Applying when vehicle is stationary

Pull switch (Ⓟ), the electrical parking brake operates automatically with adequate force. For maximum force, e.g. parking with a trailer or on inclines, pull switch (Ⓟ) twice.

The electrical parking brake can always be activated, even if the ignition is off.

Do not operate electrical parking brake system too often without engine running as this will discharge the battery.

Before leaving the vehicle, check the electrical parking brake status.

Control indicator (Ⓟ) ⇨ 85.

Releasing

Switch on ignition. Keep foot brake depressed and then push switch (Ⓟ).

If the foot brake is not depressed when attempting to release electrical parking brake, a warning chime will sound and control indicator (Ⓟ) illuminates in the instrument cluster ⇨ 90.

Drive away function

With the engine running, selecting a forward gear (manual transmission) or engaging **D** (automatic transmission) and then depressing the accelerator pedal automatically releases the electrical parking brake. This is not possible when the switch  is pulled at the same time.

This function also helps driving away on inclines.



Aggressive drive away may reduce life time of wear parts.



Dynamic braking when vehicle is moving



When the vehicle is moving and the switch  is kept pulled, a warning chime will sound and the electrical parking brake system will decelerate the vehicle, but will not apply statically.



As soon as the switch  is released, dynamic braking will be stopped.

Fault

Failure mode of electrical parking brake is indicated by control indicator   85.

In the event of a fault, to apply electrical parking brake: pull and hold the switch  for a few seconds. If control indicator  illuminates, electrical parking brake has been applied successfully.

To release electrical parking brake: push and hold the switch  for a few seconds. If control indicator  extinguishes, electrical parking brake has been released successfully.

If control indicator  flashes: electrical parking brake is not fully applied or released. When  is continuously flashing, with ignition switched on depress brake pedal, release electrical parking brake and retry applying.

If  continues to flash, do not drive the vehicle. If necessary, place wedge blocks or equivalent in front of and behind wheels to prevent vehicle movement. Seek the assistance of a workshop to have the cause of the fault remedied.

Brake assist

If the brake pedal is depressed quickly and forcefully, maximum brake force is automatically applied (full braking).

Maintain steady pressure on the brake pedal for as long as full braking is required. Maximum brake force is automatically reduced when the brake pedal is released.

Hill start assist

The system helps prevent unintended movement when driving away on inclines.



When releasing the foot brake after stopping on an incline, the brakes remain on for a further 2 seconds. The brakes release automatically as soon as the vehicle begins to accelerate.

Ride control systems

Electronic Stability Control

Electronic Stability Control (ESC) improves driving stability when necessary, regardless of the type of road surface or tyre grip. It also prevents the drive wheels from spinning.

As soon as the vehicle starts to swerve (understeer/oversteer), engine output is reduced and the wheels are braked individually. This considerably improves the driving stability of the vehicle on slippery road surfaces.

ESC is operational as soon as control indicators  and  extinguish in the instrument cluster after switching on the ignition.

When ESC is active  flashes ⇨ 87.

Warning



Do not let this special safety feature tempt you into taking risks when driving.

Adapt speed to the road conditions.

Deactivation



With ESC active, if wheels are slipping on wet, snowy or icy roads, engine speed may not increase when accelerator pedal is depressed. The vehicle may not move.

Switch off ESC function, to allow engine rpm to increase, by pressing  briefly. Control indicator  illuminates in the instrument cluster.

ESC is reactivated by pressing  again. The control indicator extinguishes.

Control indicator  ⇨ 87.

Hydraulic brake assist

When the ESC function comes into action and recognises any emergency situation requiring hard braking, it automatically delivers increased braking pressure to the wheels.

Active rollover protection

If the vehicle moves in an unstable manner, this function helps the vehicle maintain normal stability.

Trailer stability assist

If the system detects snaking movements, engine power is reduced and the vehicle/trailer combination is selectively braked until the snaking ceases. While system is working keep steering wheel as still as possible.

Fault

If there is a fault in the system the control indicator  illuminates continuously. The system is not operational.

Have the cause of the fault remedied by a workshop.



Descent control system

The Descent control system (DCS) allows the vehicle to travel at a low speed without depressing the foot brake. The vehicle will automatically decelerate to a low speed and remain at that speed when the system is activated. Some noise or vibration from the brake system may be apparent when the system is active.

Caution



Use only when descending steep grades while driving off-road. Do not use when driving on normal road surfaces. Unnecessary usage of the DCS function, such as while driving on normal roads, may damage the brake system and the ESC function.

Activation

At speeds below approx. 50 km/h, press . The green control indicator  flashes in the instrument cluster, to

show DCS is in operation. DCS will not activate at speeds above 50 km/h, even if the button is pressed.

Deactivation

Press  again. The green control indicator  extinguishes. Depressing the foot brake or accelerator will also cause the system to be deactivated.

Fault

The yellow control indicator  flashes to indicate that the system is not ready for conditions to operate, due to the high temperature (approx. 350 - 400 °C) of friction material, through severe or repeated braking. It will extinguish when the temperature drops below 350 °C.

The yellow control indicator  illuminates when there is a malfunction in the system, due to the extremely high temperature (over 400 °C) of friction material, through severe or repeated braking. It will extinguish when the temperature drops below 350 °C. These

temperatures may differ according to vehicle conditions or outside conditions.

Flashing or illumination of the yellow control indicator  reminds the driver that the friction material needs to cool down: drive the vehicle without braking as much as possible. If the control indicator does not extinguish, have the cause of the fault remedied by a workshop.

DSC control indicators   86.

Automatic level control

The rear level of the vehicle is automatically adjusted to the load conditions while driving. Suspension and ground clearance are increased, which improves driving conditions.

The automatic level control is activated after the vehicle has been driven for some distance, depending on the vehicle load and the road conditions.

Do not use full payload in the event of a fault. Have the cause of the fault remedied by a workshop.

Headlight range adjustment  106.

Driver assistance systems

Warning

Driver assistance systems are developed to support the driver and not to replace the driver's attention.

The driver accepts full responsibility when driving the vehicle.

When using driver assistance systems, always take care regarding the current traffic situation.

Cruise control

The cruise control can store and maintain speeds above 40 km/h. Deviations from the stored speeds may occur when driving uphill or downhill.

For safety reasons the cruise control cannot be activated until the foot brake has been operated once.



Do not use the cruise control if it is not advisable to maintain a constant speed.

With automatic transmission, only activate cruise control in automatic mode.

Control indicator   91.

Switching on

Press **CRUISE**; control indicator  illuminates yellow in the instrument cluster.

Activation

Accelerate to the desired speed, press **- SET** and release it. The current speed is stored and maintained. Control indicator  illuminates green. Accelerator pedal can be released.

Vehicle speed can be increased by depressing the accelerator pedal. When the accelerator pedal is released, the previously stored speed is resumed.

Increase speed

With cruise control active, press and hold **+ RES** or tap **+ RES** repeatedly: speed increases continuously or in small increments.

Alternatively accelerate to the desired speed and store by pressing **- SET**.

Reduce speed

With cruise control active, press and hold **- SET** or tap **- SET** repeatedly: speed decreases continuously or in small increments.

Switching off

Press **CRUISE**; control indicator  extinguishes and the vehicle slowly decelerates.

Automatic deactivation:

- vehicle speed below approx. 45 km/h,
- the brake pedal is depressed,
- the clutch pedal is depressed,
- selector lever in **N**,
- the Electronic Stability Control is operating.

Resume stored speed

Press **+ RES** at a speed above 45 km/h. The stored speed will be obtained.

Deleting the stored speed

The stored speed will be deleted by pressing **CRUISE** or switching off the ignition.

Parking assist

Warning

It is the driver who bears full responsibility for the parking manoeuvre.

Always check the surrounding area while reversing and using the rear parking assist system.

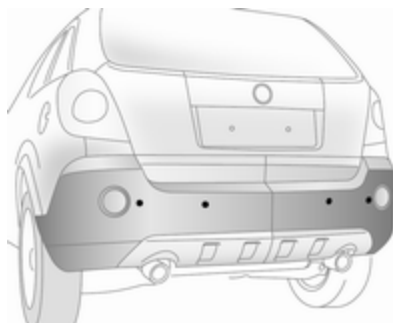

The parking assist system makes parking easier by measuring the distance between the vehicle and obstacles to the front and rear, and giving acoustic signals.

The system consists of four ultrasonic parking sensors in both the front and rear bumpers.

Control indicator **P**  ↻ 87.

Activation

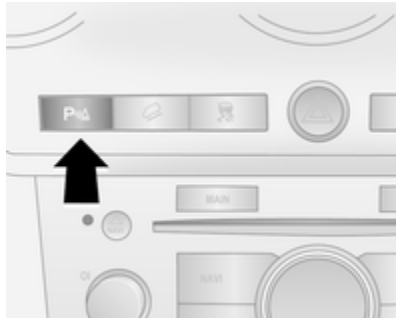

With the ignition on, the system must be activated manually.

Press **P**  on the instrument panel. The LED in the button will illuminate and will activate when a forward gear or reverse gear is engaged and the electrical parking brake is released.

An obstacle is indicated by an acoustic signal. The interval between the sounds becomes shorter as the

vehicle gets closer to the obstacle. When the distance is less than 30 cm, the signal is continuous. The acoustic signal may differ depending on the type of object detected.

Deactivation

To deactivate, press the button again and the LED in the button will extinguish. The control indicator **P**  in the instrument cluster will illuminate until the vehicle speed exceeds 25 km/h.

The system is deactivated automatically when the vehicle speed is above 8 km/h or when selector lever is in neutral (automatic transmission in **N** or **P**).

If **P**  is pressed again, the LED in the button will extinguish and the system will be reactivated as soon as a forward gear or reverse gear is engaged and the electrical parking brake is released.

Fault

In the event of a fault in the system, control indicator **P**  illuminates in the instrument cluster.

If the acoustic signal sounds 3 times continuously when there are no obstacles near the front or rear bumper, there is a fault in the system. Have the cause of the fault remedied by a workshop.

Important hints for using the parking assist system

Warning

Under certain circumstances, various reflective surfaces on objects or clothing as well as external noise sources may cause the system to fail to detect obstacles.

Special attention has to be paid to low obstacles which can damage the lower part of the bumper.

Caution

Performance of the system can be reduced when sensors are covered, e.g. by ice or snow.

Performance of the parking assist system can be reduced due to heavy loading.

Special conditions apply if there are taller vehicles in the vicinity (e.g. off-road vehicles, mini vans, vans). Object identification and correct distance indication in the upper part of these vehicles cannot be guaranteed.

Objects with a very small reflection cross-section, e.g. objects of narrow size or soft materials, may not be detected by the system.

Parking assist systems do not detect objects outside the detection range.

Fuel**Fuel for diesel engines**

Only use diesel fuel that complies with EN 590.

In countries outside the European Union use Euro-Diesel fuel with a sulphur concentration below 50 ppm.

Caution

Use of fuel that does not comply with EN 590 or similar can lead to engine power loss, increased wear or engine damage and loss of warranty.

Do not use marine diesel oils, heating oils, Aquazole and similar diesel-water emulsions. Diesel fuels must not be diluted with fuels for petrol engines.

Refuelling**⚠ Danger**

Before refuelling, switch off engine and any external heaters with combustion chambers. Switch off any mobile phones.

Follow the operating and safety instructions of the filling station when refuelling.

⚠ Danger

Fuel is flammable and explosive. No smoking. No naked flames or sparks.

If you can smell fuel in your vehicle, have the cause of this remedied immediately by an authorized dealer.

Caution

In case of misfuelling, do not switch on ignition.

Fuel filler flap is located at left rear side of vehicle.

The fuel filler flap can only be opened if the vehicle is unlocked ⇨ 22.

Release the fuel filler flap by pushing the flap.

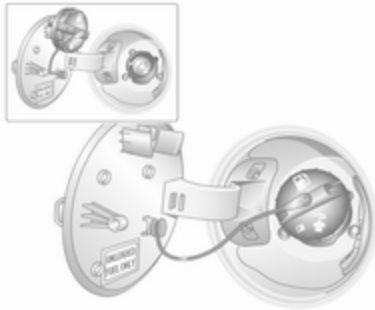

To unlock fuel filler cap: turn it anticlockwise. If hissing occurs, wait until it stops before completely unscrewing the cap.

The fuel filler cap can be retained in the holder on the inside of the fuel filler flap.

When refuelling, fully insert the pump nozzle and switch it on.

After automatic cut-off, the tank can be topped up by operating the pump nozzle a maximum of two more times.

Caution

Wipe off any overflowing fuel immediately.

After refuelling, replace the fuel filler cap and turn it clockwise until you hear several clicks. Ensure the cap is screwed in completely, otherwise control indicator  may illuminate in the instrument cluster ⇨ 84.

Close fuel filler flap.

Fuel filler cap

Only a genuine fuel filler cap provides full functionality. Diesel-engined vehicles have special fuel filler caps.

Fuel consumption - CO₂-Emissions

The fuel consumption (combined) of the model Opel Antara is within a range of 10.9 to 6.3 l/100 km.

The CO₂ emission (combined) is within a range of 255 to 167 g/km.

For the values specific for your vehicle, refer to the EEC Certificate of Conformity provided with your vehicle or other national registration documents.

General information

The official fuel consumption and specific CO₂ emission figures quoted relate to the EU base model with standard equipment.

Fuel consumption data and CO₂ emission data are determined according to regulation R (EC) No. 715/2007 (in the latest applicable version), taking into consideration the vehicle weight in running order, as specified by the regulation.

The figures are provided only for the purpose of comparison between different vehicle variants and must not be taken as a guarantee for the actual fuel consumption of a particular vehicle. Additional equipment may result in slightly higher results than the stated



consumption and CO₂ figures. Furthermore, fuel consumption is dependent on personal driving style as well as road and traffic conditions.

Trailer hitch

General information

The coupling ball bar is kept in a bag, fastened with a strap and is stowed below the floor cover in the load compartment.

Only use towing equipment that has been approved for your vehicle. Entrust retrofitting of towing equipment to a workshop. It may be necessary to make changes that affect the cooling system, heat shields or other equipment.

Control indicator  illuminates in the instrument cluster when a trailer is connected to the vehicle  91.

Driving characteristics and towing tips

In the case of trailers with brakes, attach the break-away stopping cable to the eye - not to the coupling ball bar.

If no eye is available, loop cable around coupling ball bar. Ensure cable is crossed under the vertical

coupling socket to ensure the trailer nose cannot drop to the ground if it becomes separated from the trailer hitch. Do not allow the cable to drag along the ground and always allow enough slack to permit full turning. Follow the instructions supplied with the towing equipment.

Before attaching a trailer, lubricate the coupling ball. However, do not do so if a stabiliser, which acts on the coupling ball, is being used to reduce snaking movements. For trailers with low driving stability, the use of a friction-type stabiliser is strongly recommended.

Do not drive faster than 80 km/h, even in countries where higher speeds are permitted. When driving uphill, do not drive faster than 30 km/h in 1st gear, or 50 km/h in 2nd gear.

If the trailer starts snaking, drive more slowly, do not attempt to correct the steering and brake sharply if necessary.

When driving downhill, drive in the same gear as if driving uphill and drive at a similar speed.

Adjust tyre pressure to the value specified for full load ⇨ 212.

Trailer towing

Trailer loads

The permissible trailer loads are vehicle-dependent and engine-dependent maximum values which must not be exceeded. The actual trailer load is the difference between the actual gross weight of the trailer and the actual coupling socket load with the trailer coupled.

When the trailer load is being checked, therefore, only the trailer wheels - and not the jockey wheel - must be standing on the weighing apparatus.

The permissible trailer loads are specified in the vehicle documents. In general, they are valid for gradients up to max. 12%.

The permitted trailer load applies up to the specified incline and up to an altitude of 1000 metres above sea level. Since engine power decreases as altitude increases due to the air

becoming thinner, therefore reducing climbing ability, the permissible gross train weight also decreases by 10% for every 1000 metres of additional altitude. The gross train weight does not have to be reduced when driving on roads with slight inclines (less than 8%, e.g. motorways).

The permissible gross train weight must not be exceeded. This weight is specified on the identification plate ⇨ 205.

Vertical coupling load

The vertical coupling load is the load exerted by the trailer on the coupling ball. It can be varied by changing the weight distribution when loading the trailer.

The maximum permissible vertical coupling load (80 kg) is specified on the towing equipment identification plate and in the vehicle documents. Always aim for the maximum load, especially in the case of heavy trailers. The vertical coupling load should never fall below 25 kg.

When measuring the vertical coupling load, ensure the drawbar of the loaded trailer is at the same height as it will be when the trailer is coupled with the towing vehicle loaded. This is particularly important for trailers with tandem axle.

Rear axle load

When the trailer is coupled and the towing vehicle is fully loaded (including all occupants), the permissible rear axle load (see identification plate or vehicle documents) must not be exceeded.

National regulations regarding maximum speeds for vehicles towing a trailer must be observed.

Towing equipment

Caution

When operating without a trailer, remove the coupling ball bar.

Towing equipment with detachable coupling ball bar

The coupling ball bar is kept in a bag, fastened with a strap and is stowed below the floor cover in the load compartment.

Fitting the coupling ball bar

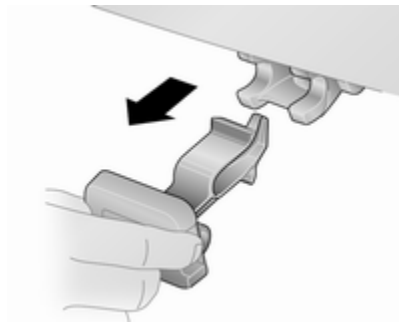

Remove sealing plug from the hole for the coupling ball bar and stow it in the load compartment.

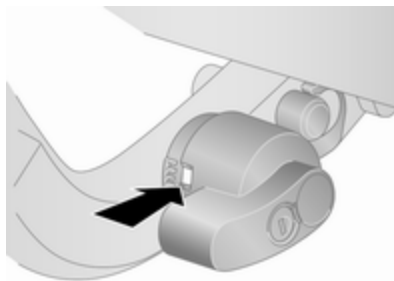

Confirm that the colour marking on the lever is red.

Inserting the coupling ball bar

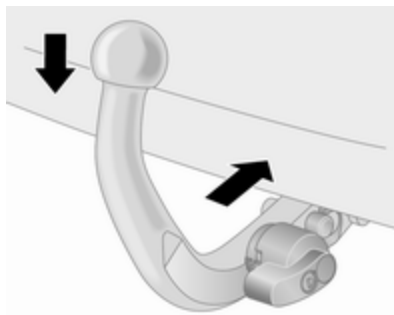

Insert the coupling ball bar into the coupling housing and push firmly downwards until the coupling ball bar audibly engages. If it does not engage, repeat fitting procedure.

Do not swing the coupling ball bar to the left or right, or upwards and downwards, to avoid disrupting correct fitting.

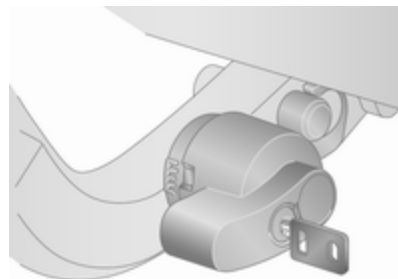

Lock coupling ball bar by turning the supplied key in the lock cylinder of the coupling ball bar. Remove key.

Check that the coupling ball bar is correctly attached:

- Green marking must be visible on lever.
- Coupling ball bar must be seated firmly in coupling housing.

Coupling ball bar must be locked and key must be removed.

⚠ Warning

Towing a trailer is permitted only when the coupling ball bar is fitted correctly. If the coupling ball bar cannot be properly attached, seek the assistance of a workshop.

Eye for break-away stopping cable

In the case of trailers with brakes, attach the break-away stopping cable to the eye - not to the coupling ball bar.

Dismounting the coupling ball bar



Unlock coupling ball bar and remove key. Push lever to the left, towards the coupling ball bar and turn it downwards. Pull coupling ball bar out of coupling housing.

Remove any rust or dirt from area around the coupling housing and coupling ball bar connection before inserting sealing plug in the hole.

Place the coupling ball bar in the bag supplied, fasten it with the strap and stow it below the floor cover in the load compartment.

Do not use steam-jet cleaners or other high-pressure cleaners to clean the coupling ball bar.

Trailer stability assist

If the system detects snaking movements, engine power is reduced and the vehicle/trailer combination is selectively braked until the snaking ceases. While system is working keep steering wheel as still as possible.

Trailer stability assist (TSA) is a function of the Electronic Stability Control ↻ 145.

Vehicle care

General Information 157

Accessories and vehicle modifications	157
Vehicle storage	157
End-of-life vehicle recovery	158

Vehicle checks 158

Performing work	158
Bonnet	158
Engine oil	159
Engine coolant	160
Power steering fluid	161
Washer fluid	161
Brakes	161
Brake fluid	162
Clutch fluid	162
Vehicle battery	162
Diesel fuel filter	164
Diesel fuel system bleeding	165
Wiper blade replacement	165

Bulb replacement 165

Headlights	165
Halogen headlights	166
Xenon headlights	167
Fog lights	168
Tail lights	169

Side turn signal lights	170
Centre high-mounted brake light	170
Number plate light	170
Interior lights	170
Instrument panel illumination ...	171

Electrical system 171

Fuses	171
Engine compartment fuse box .	173
Instrument panel fuse box	176

Vehicle tools 179

Tools	179
-------------	-----

Wheels and tyres 181

Winter tyres	181
Tyre designations	181
Tyre pressure	182
Tyre pressure monitoring system	183
Tread depth	186
Changing tyre and wheel size .	186
Wheel covers	187
Tyre chains	187
Tyre repair kit	187
Wheel changing	190
Spare wheel	193

Jump starting 194

Towing 196

Towing the vehicle	196
Towing another vehicle	197

Appearance care 198

Exterior care	198
Interior care	200

General Information

Accessories and vehicle modifications

We recommend the use of genuine parts and accessories and factory approved parts specific for your vehicle type. We cannot assess or guarantee reliability of other products - even if they have a regulatory or otherwise granted approval.

Do not make any modifications to the electrical system, e.g. changes of electronic control units (chip tuning).

Caution
When transporting the vehicle on a train or on a recovery vehicle, the mud flaps might be damaged.

Vehicle storage

Storage for a long period of time

If the vehicle is to be stored for several months:

- Wash and wax the vehicle.
- Have the wax in the engine compartment and underbody checked.
- Clean and preserve the rubber seals.
- Change the engine oil.
- Drain the washer fluid reservoir.
- Check the coolant antifreeze and corrosion protection.
- Adjust tyre pressure to the value specified for full load.
- Park the vehicle in a dry, well ventilated place. Engage first or reverse gear or move selector lever to **P**. Prevent the vehicle from rolling.
- Do not apply the electrical parking brake.

- Open the bonnet, close all doors and lock the vehicle.
- Disconnect the clamp from the negative terminal of the vehicle battery. Beware that all systems are not functional, e.g. anti-theft alarm system.

Putting back into operation

When the vehicle is to be put back into operation:

- Connect the clamp to the negative terminal of the vehicle battery. Activate the electronics of the power windows.
- Check tyre pressure.
- Fill up the washer fluid reservoir.
- Check the engine oil level.
- Check the coolant level.
- Fit the number plate if necessary.

End-of-life vehicle recovery

Information on end-of-life vehicle recovery centres and the recycling of end-of-life vehicles is available on our website, where legally required. Only entrust this work to an authorised recycling centre.

Vehicle checks

Performing work

⚠ Warning

Only perform engine compartment checks when the ignition is off.
The cooling fan may start operating even if the ignition is off.

⚠ Danger

The ignition system and Xenon headlights use extremely high voltage. Do not touch.

Bonnet

Opening



Pull the release lever and return it to its original position.

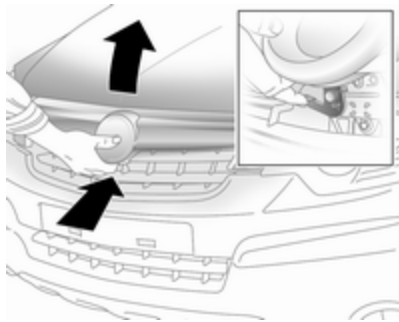

Locate the safety catch, found slightly left of centre on the underside of the bonnet, push the catch upwards and lift the bonnet gently.

The bonnet is held open automatically.

If the bonnet is opened during an Autostop, the engine will be restarted automatically for safety reasons.

Stop-start system ⇨ 126.

Closing

Lower the bonnet and let it fall into the latch from a low height (20-25 cm). Check that the bonnet is engaged.

Caution

Do not press the bonnet into the latch to avoid dents.

Air intake ⇨ 120.

Engine oil

Check the engine oil level manually on a regular basis to prevent damage to the engine.

Ensure that the correct specification of oil is used. Recommended fluids and lubricants ⇨ 202.

The maximum engine oil consumption is 0.6 litres per 1000 km.

Check with the vehicle on a level surface. The engine must be at operating temperature and switched off for at least 5 minutes.

Pull out the dipstick, wipe it clean, insert it to the stop on the handle, pull out and read the engine oil level.

Insert dipstick to the stop on the handle and make half a turn.

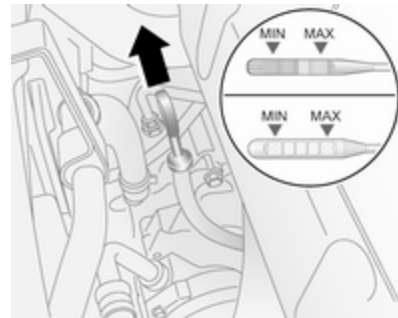

Different dipsticks are used depending on engine variant.

When the engine oil level has dropped to the **MIN** mark, top up engine oil.

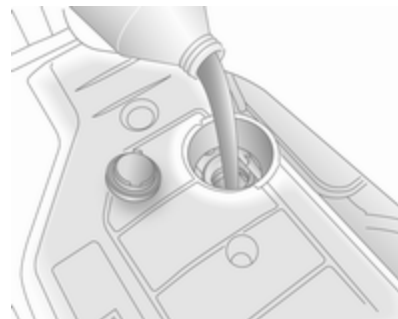

We recommend the use of the same grade of engine oil that was used at the last oil change.



The engine oil level must not exceed the **MAX** mark on the dipstick.

Caution

Overfilled engine oil must be drained or suctioned out.

Capacities ↻ 211, Engine oil quality/viscosity ↻ 202.

Fit the cap on straight and tighten it.

Control indicators for engine oil pressure  ↻ 88, engine oil life  ↻ 89, and low engine oil  ↻ 89.

Once the engine oil has been changed, the engine oil life monitor needs to be reset. Seek the assistance of a workshop.

Engine coolant

The coolant provides freeze protection down to approx. -28°C . In northern countries with very low

temperatures the factory filled coolant provides frost protection down to approx. -37°C .

Caution

Only use approved antifreeze.

Coolant level

Caution

Too low a coolant level can cause engine damage.

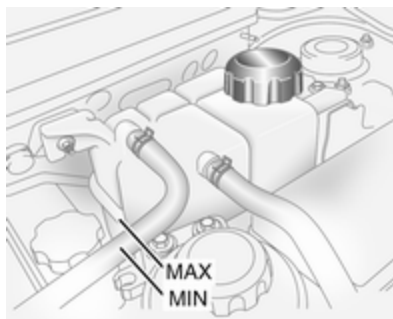

If the cooling system is cold, the coolant level should be between the **MIN** and **MAX** marks. Top up if the level is low.

Warning

Allow the engine to cool before opening the cap. Carefully open the cap, relieving the pressure slowly.

To top up use a 1:1 mixture of released coolant concentrate mixed with clean tap water. If no coolant concentrate is available, use clean tap water. Install the cap tightly. Have the coolant concentration checked and have the cause of the coolant loss remedied by a workshop.

Engine coolant temperature control indicator  ↻ 87.

Power steering fluid

Caution

Extremely small amounts of contamination can cause steering system damage and cause it to not work properly. Do not allow contaminants to contact the fluid side of the reservoir cap/dipstick or from entering the reservoir.

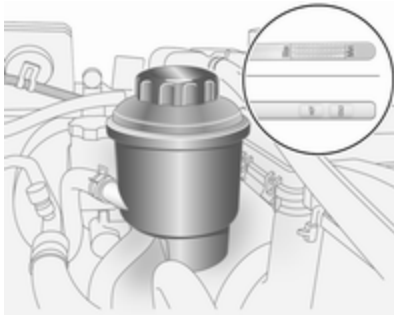

Open the cap and remove. Wipe the dipstick dry and turn the cap in the container. Open the cap again and read the power steering fluid level.

The power steering fluid level must be between the **MIN/COLD** and the **MAX/HOT** marks.

If the fluid level is too low, seek the assistance of a workshop.

Washer fluid

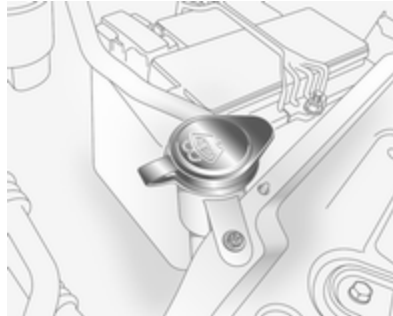

Fill with clean water mixed with a suitable quantity of washer fluid which contains antifreeze. For the correct mixing ratio refer to the washer fluid container.

Caution

Only washer fluid with a sufficient antifreeze concentration provides protection at low temperatures or a sudden drop in temperature.

Do not spray washer fluid onto windscreen in freezing weather, to avoid ice forming and impairing vision.

In cold weather, do not fill the washer fluid reservoir more than three quarters full, to allow enough room for expansion if the fluid freezes, and to prevent damage to the reservoir.

Brakes

In the event of minimum thickness of the brake lining, a squealing noise sounds during braking.

Continued driving is possible but have the brake lining replaced as soon as possible.

Once new brake linings are installed, do not brake unnecessarily hard for the first few journeys.

Brake fluid

⚠ Warning

Brake fluid is poisonous and corrosive. Avoid contact with eyes, skin, fabrics and painted surfaces.

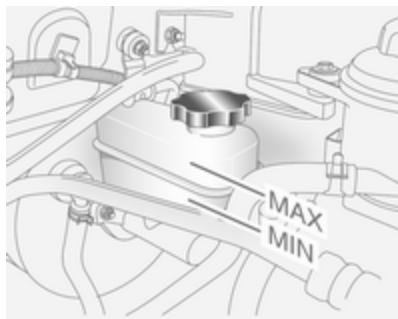

The brake fluid level must be between the **MIN** and **MAX** marks.

When topping up, ensure maximum cleanliness as contamination of the brake fluid can lead to brake system malfunctions. Have the cause of the loss of brake fluid remedied by a workshop.

Caution

Only use high-performance brake fluid approved for the vehicle.
Brake fluid ⇨ 202.

Brake fluid level control indicator ⓘ
⇨ 85.

Clutch fluid

⚠ Warning

Clutch fluid is poisonous and corrosive. Avoid contact with eyes, skin, fabrics and painted surfaces.

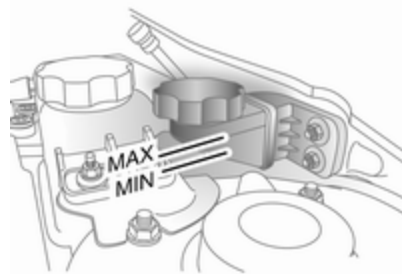

If the fluid in the reservoir falls below the **MIN** mark, seek the assistance of a workshop.

Clutch fluid ⇨ 202.

Vehicle battery

The vehicle battery is maintenance-free provided that the driving profile allows sufficient charging of the battery. Short-distance-driving and frequent engine starts can discharge the vehicle battery. Avoid the use of unnecessary electrical consumers.



Batteries do not belong in household waste. They must be disposed of at an appropriate recycling collection point.

Laying up the vehicle for more than 6 weeks can lead to battery discharge. Disconnect the clamp from the negative terminal of the vehicle battery.

Ensure the ignition is switched off before connecting or disconnecting the vehicle battery.

Retrofitted electrical or electronic accessories can place an additional load on the vehicle battery or discharge the battery. Seek the assistance of a workshop regarding technical possibilities, such as fitting a more powerful battery.

Ensure the ignition is switched off before reconnecting the vehicle battery. Then perform the following actions:

1. Set date and time in the information display ↻ 75.
2. If necessary, activate the power windows and sun roof ↻ 31, ↻ 33.

In order to prevent the vehicle battery from discharging, some consumers such as the courtesy lights automatically switch off after a delay.

Charge a disconnected vehicle battery every 6 weeks.

Vehicle battery discharge protection ↻ 113.

Replacing the vehicle battery

Note

Any deviation from the instructions given in this paragraph may lead to a temporary deactivation of the stop-start system.

When the vehicle battery is being replaced, please ensure that there are no open ventilation holes in the vicinity of the positive terminal. If a ventilation hole is open in this area, it

must be closed off with a dummy cap, and the ventilation in the vicinity of the negative terminal must be opened.

Only use batteries that allow the fuse box to be mounted above the vehicle battery.

In vehicles with an AGM (Absorptive Glass Mat) battery, make sure to have the battery replaced with another AGM battery.



An AGM battery can be identified by the label on the battery. We recommend the use of an original Opel battery.

Note

Using an AGM vehicle battery different from the original Opel vehicle battery may result in a lower performance of the stop-start system.

We recommend that you have the vehicle battery replaced by a workshop.

Stop-start system ⇨ 126.

Charging the vehicle battery**⚠ Warning**

On vehicles with stop-start system, ensure that the charging potential does not exceed 14.6 volts when using a battery charger. Otherwise the vehicle battery might be damaged.

Jump starting ⇨ 194.

Warning label

Meaning of symbols:

- No sparks, naked flames or smoking.
- Always shield eyes. Explosive gases can cause blindness or injury.
- Keep the vehicle battery out of reach of children.
- The vehicle battery contains sulfuric acid which could cause blindness or serious burn injuries.

- See the Owner's Manual for further information.
- Explosive gas may be present in the vicinity of the vehicle battery.

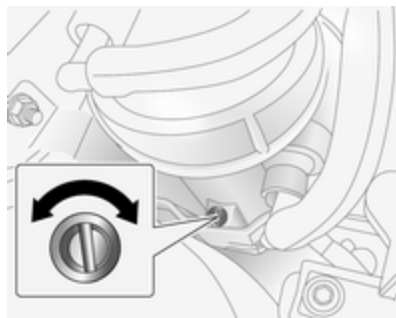
Diesel fuel filter

Drain diesel fuel filter of residual water at every engine oil change.

Place a container underneath the filter housing. Turn drain plug anticlockwise using a suitable screwdriver, to drain off the water.

The filter is drained as soon as diesel fuel emerges from the port. Retighten the drain plug by turning it clockwise.

With engine switched off, turn ignition key to **ON**, wait approx. 5 seconds, and turn key to **LOCK** to perform priming operation. Perform this operation 3 times or more while the engine is switched off, to avoid air entering the fuel line.

Check diesel fuel filter at shorter intervals if the vehicle is subjected to extreme operating conditions.

If there is water in the diesel fuel filter, control indicator  illuminates in the instrument cluster \rightarrow 90. Drain the water immediately.

Diesel fuel system bleeding

If the fuel tank has been run dry, the diesel fuel system must be bled. Switch on the ignition three times for 15 seconds at a time. Then crank the engine for a maximum of 40 seconds. If the engine will not start, wait at least 10 seconds before trying again. If the engine fails to start, seek the assistance of a workshop.

Wiper blade replacement

Wiper blades on the windscreen

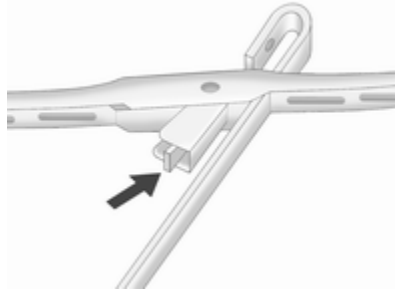

Lift wiper arm, press and hold retaining clip and detach wiper blade.

Attach the wiper blade slightly angled to the wiper arm and push until it engages.

Lower wiper arm carefully.

Bulb replacement

Switch off the ignition and turn off the relevant switch or close the doors.

Only hold a new bulb at the base! Do not touch the bulb glass with bare hands.

Use only the same bulb type for replacement.

Replace headlight bulbs from within the engine compartment.

Bulb check

After a bulb replacement switch on the ignition, operate and check the lights.

Headlights

Headlamp removal

For bulb replacement, it is necessary to first remove the headlamp assembly.

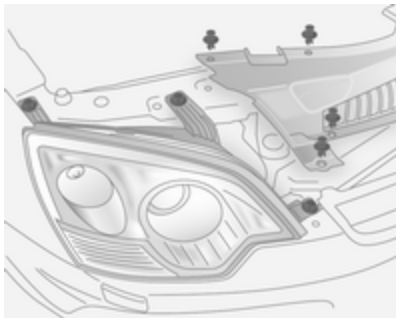

Halogen headlights

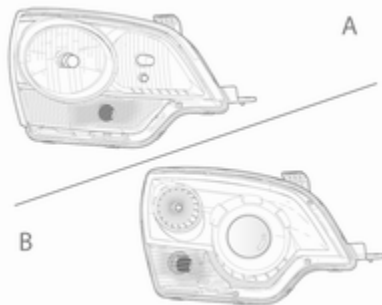

Halogen headlights **A** can be identified from Xenon headlights **B** by the different lens layout.

1. Switch off the ignition and headlight switch.
2. Open the bonnet, release the 11 retainers and remove the radiator cover.
3. Remove 3 bolts and withdraw headlamp.
4. Depress harness connector tags and disconnect headlamp wiring.
5. Remove the headlamp assembly.

Headlamp assembly installation is the reverse of removal - ensure locating dowel aligns with its socket. Do not overtighten bolts or retainers.

Low and high beam

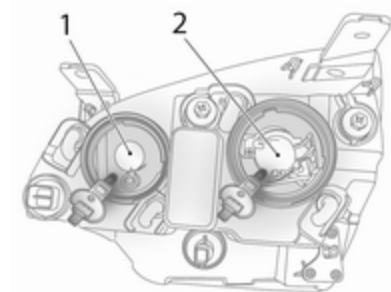

Halogen headlights have separate systems for high beam **1** (inner bulbs) and low beam **2** (outer bulbs).

1. Remove headlamp assembly
⇨ 165.
2. Remove headlamp cap.
3. Release bulb retaining spring and remove bulb from reflector housing.
4. When inserting a new bulb, ensure the lugs engage correctly with the recesses on the reflector.

- Engage bulb retaining spring and replace headlamp cap.
- Reinstall headlamp assembly.

Front turn signal

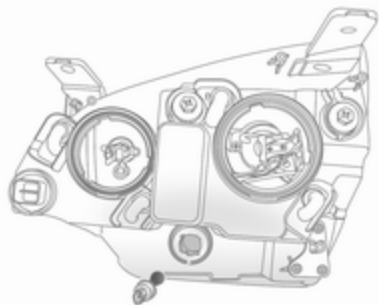

- Remove headlamp assembly ↻ 165.
- Rotate bulb holder anticlockwise and withdraw bulb holder from lamp assembly.
- Press and rotate bulb anticlockwise to remove it from bulb holder.
- Insert new bulb into bulb holder by pressing and rotating it clockwise.

- Reinstall bulb holder in lamp assembly by rotating it clockwise.
- Reinstall headlamp assembly.

Sidelights

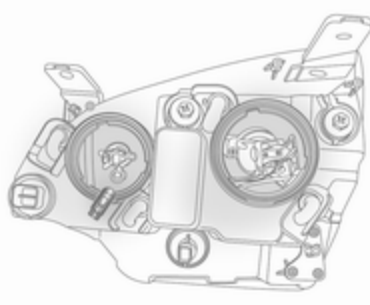

- Remove headlamp assembly ↻ 165.
- Remove headlamp cap and withdraw bulb holder (located next to high beam bulb) from lamp assembly.
- Remove bulb from bulb holder by pulling it straight out.
- Insert new bulb, using a lint-free cloth to hold bulb.

- Reinstall bulb holder in lamp assembly and replace headlamp cap.
- Reinstall headlamp assembly.

Xenon headlights

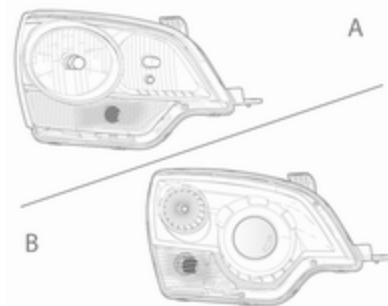

Xenon headlights **B** can be identified from Halogen headlights **A** by the different lens layout.

Low and high beam

⚠ Danger

Xenon headlights work under extremely high electrical voltage. Do not touch. Have bulbs replaced by a workshop.

Front turn signal

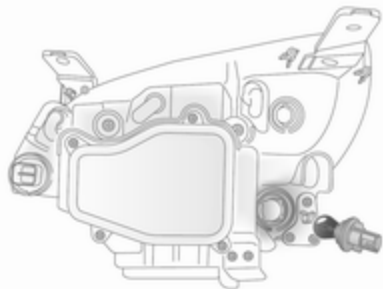

1. Remove headlamp assembly
⇨ 165.
2. Rotate bulb holder anticlockwise and withdraw bulb holder from lamp assembly.

3. Press and rotate bulb anticlockwise to remove it from bulb holder.
4. Insert new bulb into bulb holder by pressing and rotating it clockwise.
5. Reinstall bulb holder in lamp assembly by rotating it clockwise.
6. Reinstall headlamp assembly.

Sidelights

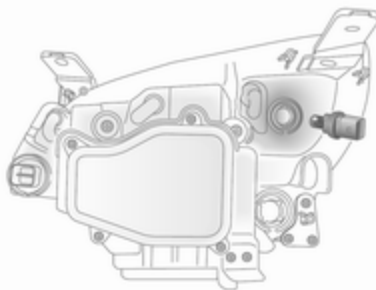

1. Remove headlamp assembly
⇨ 165.
2. Rotate bulb holder anticlockwise and withdraw bulb holder from lamp assembly.

3. Remove bulb from bulb holder by pulling it straight out.
4. Insert new bulb, using a lint-free cloth to hold bulb.
5. Reinstall bulb holder in lamp assembly by rotating it clockwise.
6. Reinstall headlamp assembly.

Fog lights

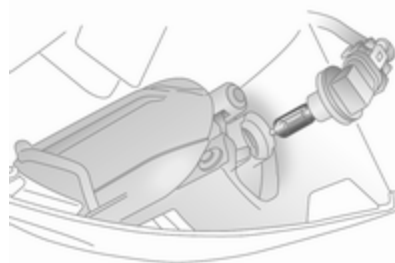

1. Remove 2 screws from panel on underside of vehicle below front fog lights and remove panel.
2. Disconnect harness connector from bulb holder and rotate bulb holder anticlockwise.

3. Remove bulb holder from lamp assembly, rotate bulb anticlockwise and remove from bulb holder.
4. Insert new bulb into bulb holder and rotate it clockwise.
5. Reinstall bulb holder in lamp assembly and reconnect harness connector.
6. Reinstall panel to underside of vehicle using 2 screws removed earlier.

Tail lights

Rear brake, tail, turn signal, reverse and fog tail light

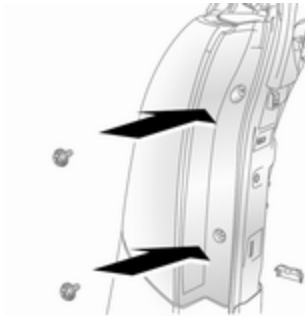

1. Open the tailgate and remove 2 screws and lamp assembly.
2. Remove bulb holder by rotating it anticlockwise.
3. Remove bulb from bulb holder by pressing the bulb in and rotating it anticlockwise.
4. Insert new bulb into bulb holder.
5. Reinstall bulb holder into lamp assembly. Rotate bulb holder clockwise and ensure it is secure.

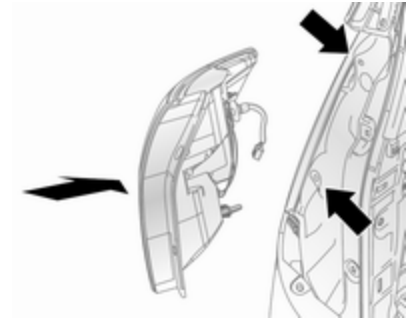

6. Replace lamp assembly by guiding lugs on lamp assembly into their corresponding apertures.
7. Replace 2 screws removed earlier and close the tailgate.

Side turn signal lights

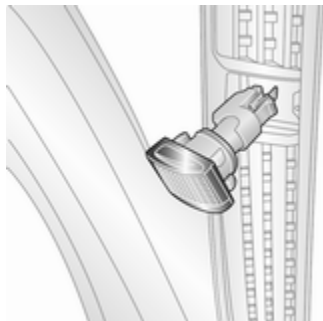

1. Using a suitable screwdriver, pry lamp assembly away from wing.
2. Rotate bulb holder anticlockwise.
3. Remove bulb from lamp assembly by pulling bulb straight out of bulb holder.
4. Insert new bulb into bulb holder by pressing it in and rotating the bulb holder clockwise.
5. Push lamp assembly back into aperture.

Centre high-mounted brake light

Have bulbs replaced by a workshop.

Number plate light



1. Remove 4 screws (arrowed) and remove lamp covers.
2. Remove bulb holder from lamp assembly by rotating it anticlockwise.
3. Pull bulb straight out of bulb holder.
4. Insert new bulb.

5. Reinstall bulb holder into lamp assembly, rotate bulb holder clockwise and ensure it is secure.
6. Replace lamp covers using the 4 screws removed earlier.

Interior lights

Front reading lights

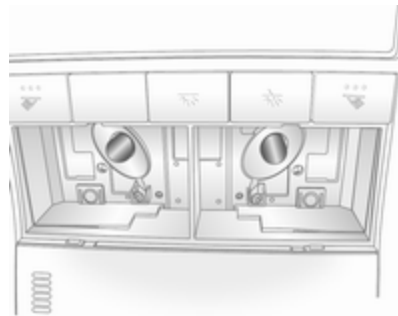

1. Using a suitable screwdriver, pry lamp lens away from roof console.
2. Remove bulb.
3. Insert new bulb.
4. Reinstall lamp lens in roof console.

Rear reading lights

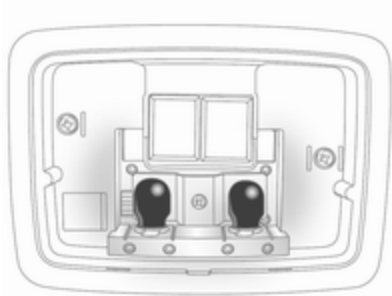

1. Using a suitable screwdriver, pry lamp lens away from roof console.
2. Remove bulb.
3. Insert new bulb.
4. Reinstall lamp lens in roof console.

Load compartment light

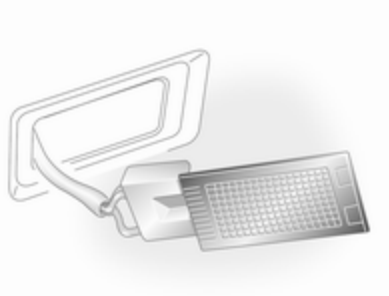

1. Using a suitable screwdriver, remove lens from lamp assembly.
2. Remove bulb.
3. Insert new bulb.
4. Reinstall lens to lamp assembly.

Glovebox light

Have bulbs replaced by a workshop.

Instrument panel illumination

Have bulbs replaced by a workshop.

Electrical system

Fuses

Data on the replacement fuse must match the data on the defective fuse. There are two fuse boxes in the vehicle:

- in the engine compartment next to the coolant reservoir,
- in the instrument panel, on the left-hand side of the front passenger seat foot well, or, in right-hand drive vehicles, on the left-hand side of the driver's seat foot well.

Before replacing a fuse, turn off the respective switch and the ignition.

A blown fuse can be recognized by its melted wire. Do not replace the fuse until the cause of the fault has been remedied.

Some functions are protected by several fuses. Fuses may also be inserted without existence of a function.

Note

Not all fuse box descriptions in this manual may apply to your vehicle.

When inspecting the fuse box, refer to the fuse box label.

It is advisable to carry a full set of spare fuses. Spare fuses can be stored in the engine compartment fuse box.

**Fuse extractor**

A fuse extractor may be located in the engine compartment fuse box.

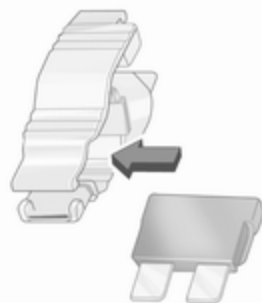
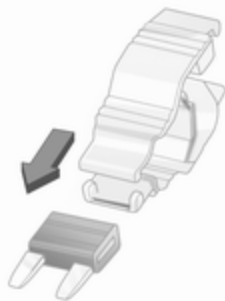

Place the fuse extractor on the various types of fuse from the top or side, and withdraw fuse.

Engine compartment fuse box

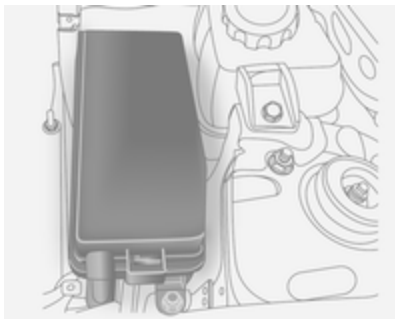

The fuse box is located next to the coolant reservoir in the engine compartment.

To open, disengage cover and tilt upwards.

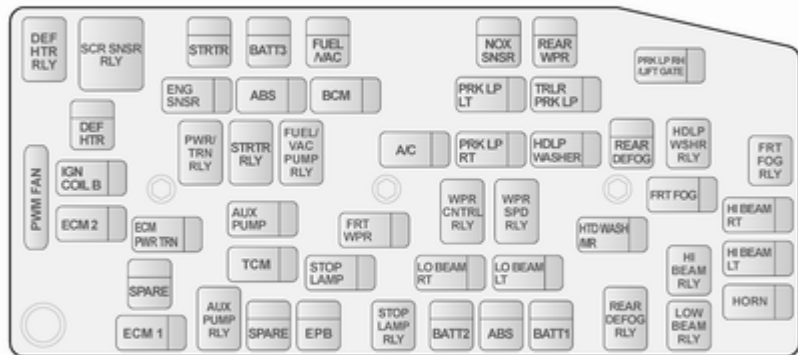

Fuse	Circuit	Fuse	Circuit	Fuse	Circuit
ABS	Anti-lock Brake System	ECM PWR TRN	Engine Control Module, Power-train	LO BEAM LT	Low beam (left-hand)
A/C	Climate control, air conditioning system	ENG SNSR	Engine sensors	LO BEAM RT	Low beam (right-hand)
AUX PUMP	Auxiliary pump	EPB	Electrical parking brake	NOX SNSR	NOX Sensor
BATT1	Instrument panel fuse box	FRT FOG	Front fog lights	PRK LP LT	Parking light (left-hand)
BATT2	Instrument panel fuse box	FRT WPR	Front wiper	PRK LP RT/LIFT GATE	Parking light (right-hand), tail-gate
BATT3	Instrument panel fuse box	FUEL/VAC	Fuel pump, vacuum pump	PWM FAN	Pulse width modulation fan
BCM	Body Control Module	HDLP WASHER	Headlight washer	REAR DEFOG	Heated rear window
DEF HTR	Diesel Exhaust Fluid Heater	HI BEAM LT	High beam (left-hand)	REAR WPR	Rear wiper
ECM1	Engine Control Module	HI BEAM RT	High beam (right-hand)	SPARE	–
ECM2	Engine Control Module	HORN	Horn	STOP LAMP	Brake lights
		HTD WASH/MIR	Heated washer fluid, heated exterior mirrors	STRTR	Starter
		IGN COIL B	Ignition coil		

Fuse	Circuit
TCM	Transmission Control Module
TRLR PRL LP	Trailer parking lights

After changing of defective fuses close the fuse box cover and press until it engages.

If the fuse box cover is not closed correctly, malfunctions may occur.

Instrument panel fuse box

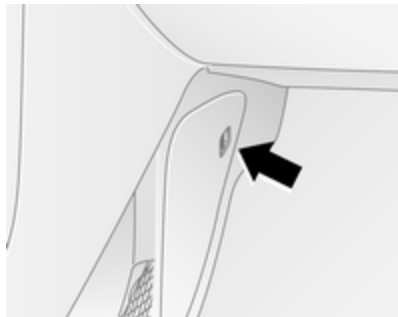

The fuse box is located on the left-hand side of the front passenger seat foot well, or, in right-hand drive vehicles, on the left-hand side of the driver's seat foot well.

Release latch to open cover.

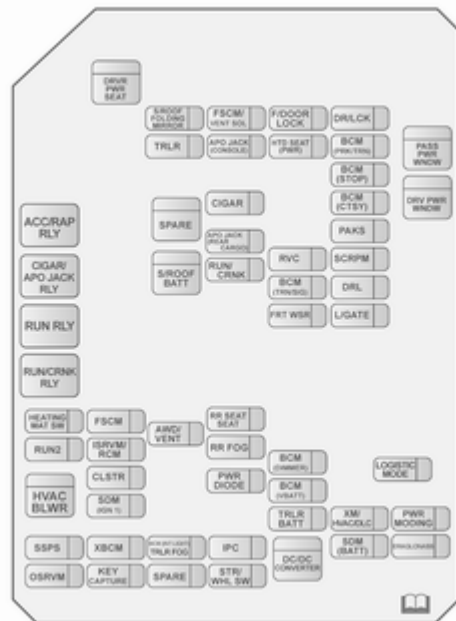

Fuse	Circuit
APO JACK (CONSOLE)	Power outlet (centre console)
APO JACK (REAR CARGO)	Power outlet (load compartment)
AUDIO/KEY CAPTURE	Audio, key capture
AWD/VENT	All-wheel drive, ventilation
BCM (CTSY)	Courtesy lights
BCM (DIMMER)	Instrument illumination
BCM (INT LIGHT TRLR FOG)	Interior lights, trailer fog light
BCM (PRK/TRN)	Parking lights, turn signals
BCM (STOP)	Brake lights
BCM (TRN SIG)	Turn signals
BCM (VBATT)	Battery voltage

Fuse	Circuit
CLSTR	Instrument cluster
DC/DC CONVERTER	DC, DC converter
DRL	Daytime running lights
DR/LCK	Driver door lock
DRVR PWR SEAT	Driver power seat
DRV/PWR WNDW	Driver power window
ERAGLONASS	Emergency road assistance Glonass
F/DOOR LOCK	Fuel filler flap
FRT WSR	Front washer
FSCM	Fuel system
FSCM/VENT SOL	Fuel system, vent solenoid
HEATING MAT SW	Heating mat switch

Fuse	Circuit
HTD SEAT PWR	Seat heating
HVAC BLWR	Climate control, air conditioning fan
IPC	Instrument panel cluster
ISRVM/RCM	Interior mirror, remote compass module
L/GATE	Tailgate
LOGISTIC MODE	Logistic mode
OSRVM	Exterior mirrors
PAKS	Passive active keyless start
PASS PWR WNDW	Passenger power window
PWR DIODE	Power diode
PWR MODING	Power moding
RR FOG	Heated rear window

Fuse	Circuit
RR HEAT SEAT	Rear seat heating
RUN 2	Power battery key on run
RUN/CRNK	Run crank
RVC	Rear view camera
RVS/HVAC/DLC	Exterior mirrors, climate control, data link connection
SCRPM	Selective catalytic reduction power module
SDM (BATT)	Safety Diagnosis Module (Battery)
SDM (IGN 1)	Safety Diagnosis Module (Ignition)
SPARE	-

Fuse	Circuit
S/ROOF/FOLDING MIRROR	Sunroof, folding mirror
S/ROOF BATT	Sunroof battery
SSPS	Power steering
STR/WHL SW	Steering wheel
TRLR	Trailer
TRLR BATT	Trailer battery
XBCM	Export Body Control Module

After changing of defective fuses close the fuse box cover and press until it engages.
If the fuse box cover is not closed correctly, malfunctions may occur.

Vehicle tools

Tools

Vehicles with spare wheel

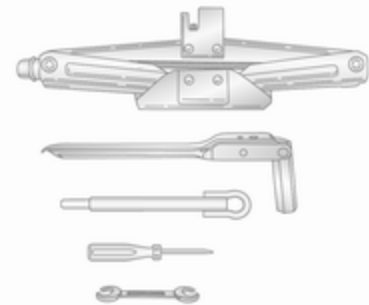

In vehicles with a spare wheel, a jack and vehicle tools kit are available.

The jack and vehicle tools have been specially developed for your vehicle and must only be used on that vehicle. Only use jack for changing wheels.

The jack and vehicle tools are in a storage compartment below the floor cover in the load compartment.

To remove the jack and vehicle tools, open the tailgate.

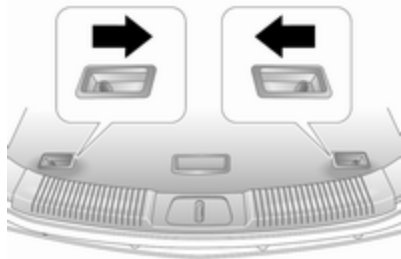

Push both levers on the floor cover towards the handle and pull up the cover by the handle.

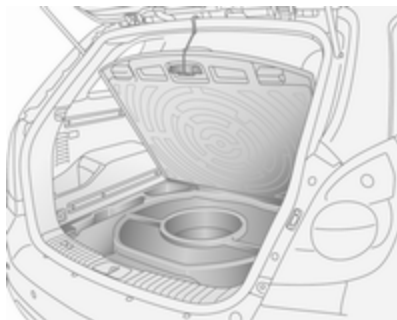

Where present, hang the hook to the upper part of the tailgate opening.

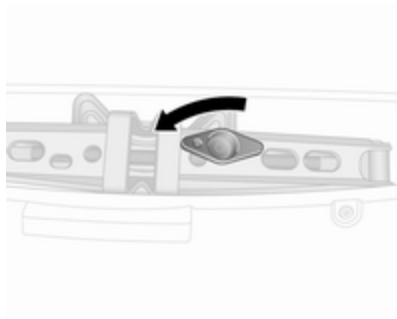

Remove wing bolt from the jack by rotating it anticlockwise and remove the jack and wheel wrench bag. Remove straps holding the bag containing the wheel wrench. Remove wheel wrench from the bag. Wheel changing ⇨ 190. Spare wheel ⇨ 193.

Vehicles with tyre repair kit

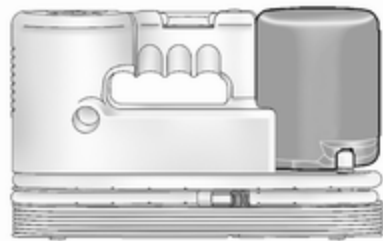

In vehicles with a tyre repair kit, there may not be a jack and vehicle tool kit. The tyre repair kit is in a storage compartment below the floor cover in the load compartment.

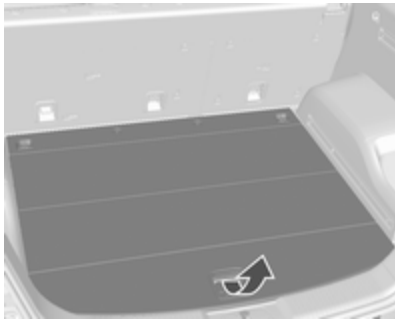

To remove the tyre repair kit, open the tailgate and pull the floor cover handle upwards ↗ 68.

Caution

Do not allow objects to protrude above the top of the rear floor storage compartment, to avoid damage to the storage area and the load compartment floor.

Tyre repair kit ↗ 187.

Wheels and tyres

Tyre condition, wheel condition

Drive over edges slowly and at right angles if possible. Driving over sharp edges can cause tyre and wheel damage. Do not trap tyres on the kerb when parking.

Regularly check the wheels for damage. Seek the assistance of a workshop in the event of damage or unusual wear.

Winter tyres

Winter tyres improve driving safety at temperatures below 7 °C and should therefore be fitted on all wheels.

In accordance with country-specific regulations, affix the speed sticker in the driver's field of view.

If winter tyres are installed that have not been approved for your vehicle, Electronic Stability Control (ESC) system performance may be affected ↗ 145. Seek the assistance of a workshop regarding availability of approved winter tyres.

If winter tyres are in use, the temporary spare wheel may still be fitted with a summer tyre. Vehicle driveability could be affected, especially on slippery road surfaces. Spare wheel ↗ 193.

Tyre designations

E.g. **235/65 R 17 104 H**

235 : Tyre width, in mm

65 : Cross-section ratio (tyre height to tyre width), %

R : Belt type: Radial

RF : Type: RunFlat

17 : Wheel diameter, in inches

104 : Load index e.g. 91 is equivalent to 618 kg

H : Speed code letter

Speed code letter:

Q : up to 160 km/h

S : up to 180 km/h

T : up to 190 km/h

H : up to 210 km/h

V : up to 240 km/h

W : up to 270 km/h

Choose a tyre appropriate for the maximum speed of your vehicle.

The maximum speed is achievable at kerb weight with driver (75 kg) plus 125 kg payload. Optional equipment could reduce the maximum speed of the vehicle.

Performance ⇨ 208.

Tyre pressure

Check the pressure of cold tyres at least every 14 days and before any long journey. Do not forget the spare wheel. This also applies to vehicles with tyre pressure monitoring system.

Use the valve cap key to make unscrewing the valve caps easier. The valve cap key is located on the inside of the tank flap.

Tyre pressure ⇨ 212.

The tyre pressure data refers to cold tyres. It applies to summer and winter tyres.

Always inflate the spare tyre to the pressure specified for full load.

The ECO tyre pressure serves to achieve the smallest amount of fuel consumption possible.

Incorrect tyre pressures will impair safety, vehicle handling, comfort and fuel economy and will increase tyre wear.

Tyre pressures differ depending on various options. For the correct tyre pressure value, follow the procedure below:

1. Identify the engine identifier code.
Engine data ⇨ 207.
2. Identify the respective tyre.

The tyre pressure tables show all possible tyre combinations ⇨ 212.

For the tyres approved for your vehicle, refer to the EEC Certificate of Conformity provided with your vehicle or other national registration documents.

The driver is responsible for correct adjustment of tyre pressure.

Warning

If the pressure is too low, this can result in considerable tyre warm-up and internal damage, leading to tread separation and even to tyre blow-out at high speeds.

Warning

For specific tyres the recommended tyre pressure as shown in the tyre pressure table may exceed the maximum tyre pressure as indicated on the tyre. Never exceed the maximum tyre pressure as indicated on the tyre.

If the tyre pressure must be reduced or increased on a vehicle with tyre pressure monitoring system, switch off ignition.

Temperature dependency

The tyre pressure depends on the temperature of the tyre. During driving, tyre temperature and pressure increase. Tyre pressure values provided on the tyre information label and tyre pressure chart are valid for cold tyres, which means at 20 °C.

The pressure increases by nearly 10 kPa for a 10 °C temperature increase. This must be considered when warm tyres are checked.

The tyre pressure value displayed in the Info-Display shows the real tyre pressure. A cooled down tyre will show a decreased value, which does not indicate an air leak.

Tyre pressure monitoring system

The tyre pressure monitoring system checks the pressure of all four wheels once per minute when vehicle speed exceeds a certain limit.

Caution

Tyre pressure monitoring system warns only about low tyre pressure condition and does not replace regular tyre maintenance by the driver.

All wheels must be equipped with pressure sensors and the tyres must have the prescribed pressure. If wheels without sensors are mounted, the tyre pressure monitoring system is not operational.

Note

In countries where the tyre pressure monitoring system is legally required, the use of wheels without pressure sensors will invalidate the vehicle type approval.

The tyre pressure sensors monitor the air pressure in the tyres and transmit tyre pressure readings to a receiver located in the vehicle.

Each tyre, including the spare, should be checked monthly when cold and inflated to the recommended inflation pressure ⇨ 212.

Low tyre pressure condition



A detected low tyre pressure condition is indicated by control indicator (L) ⇨ 88.

If (L) illuminates, stop as soon as possible and inflate the tyres as recommended ⇨ 212.

When the system detects a malfunction, (L) will flash for approx. one minute and then remain continuously illuminated. This sequence will continue upon subsequent vehicle start-ups as long as the malfunction exists.

When (L) is illuminated, the system may not be able to detect or signal low tyre pressure as intended.

If (L) illuminates at lower temperatures and extinguishes after driving, this could be an indicator for approaching a low tyre pressure condition. Check tyre pressure.

Tyre pressures in Info-Display

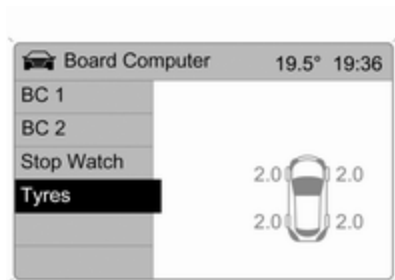

20031

The current tyre pressures can be shown in the menu item **Tyres** in the **Board Computer** menu. Press **BC** on the Infotainment system and select the menu item.

The tyre pressure monitoring system automatically detects the vehicle load. A corresponding message may appear on the Info-Display if inconsistent tyre pressures are detected. In some versions, the message is displayed in abbreviated form.

For example, the following messages can be displayed:



20021

A graphic indicating the left rear tyre is shown together with the current tyre pressure; slight pressure deviation.

Reduce speed. Check tyre pressure at next opportunity with an appropriate gauge and correct if necessary.

On the Colour-Info-Display, this message will appear in yellow.

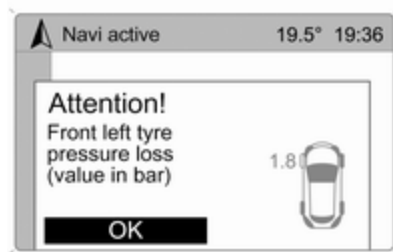

20022

A graphic indicating the front left tyre is shown together with the current tyre pressure; significant pressure deviation or direct pressure loss.

Steer out of the flow of traffic as quickly as possible without endangering other vehicles. Stop and check the tyres. Mount the spare wheel if necessary ⇨ 190.

On the Colour-Info-Display, this message will appear in red.

Acknowledgement of warnings ⇨ 92, ⇨ 94.

Vehicle messages ⇨ 99.

If the tyre pressure is to be reduced or increased, switch off the ignition. Tyre pressures ⇨ 182, ⇨ 212.

General information

The use of commercially available liquid tyre repair kits can impair the function of the system. Factory-approved tyre repair kits can be used.

Tyre repair kit ⇨ 187.

Operating electronic devices or being close to facilities using similar wave frequencies could disrupt the tyre pressure monitoring system.

The tyre pressure monitoring system valve cores and sealing rings must be replaced each time the tyres are changed.

Tyre pressure sensor matching process

Each tyre pressure sensor has a unique identification code. The identification code must be matched to a new tyre/wheel position after rotating the tyres or replacing one or more of the tyre pressure sensors.

The tyre pressure sensor matching process should also be performed after replacing a spare tyre with a road tyre containing a tyre pressure sensor. The control indicator (⚠) and the warning message should extinguish at the next ignition cycle.

The sensors are matched to the tyre/wheel positions, using a TPMS relearn tool, in the following order:

- left front tyre
- right front tyre
- right rear tyre
- left rear tyre

Consult your workshop for service or to purchase a relearn tool.

There are two minutes to match the first tyre/wheel position, and five minutes overall to match all four tyre/wheel positions. If it takes longer, the matching process stops and must be restarted.

The tyre pressure sensor matching process is as follows:

1. Apply the electrical parking brake ⇨ 143; on vehicles with automatic transmission move the selector lever to position **P**.
2. Turn the ignition on ⇨ 125.
3. Initiate the TPMS Learn Mode by simultaneously pressing **≡** and **≡** on the radio remote control, - or -

Press **INFO** on the Infotainment system until a tyre learn message appears on the Info-display. Press and hold **OK**.

The horn sounds twice and the left front turn signal also illuminates as confirmation that Learn Mode has been enabled.

4. Start with the left front tyre.
5. Place the relearn tool against the tyre sidewall, near the valve stem. Then press the button to activate the tyre pressure sensor. A horn chirp confirms that the sensor identification code has been

matched to this tyre and wheel position. The next relevant turn signal illuminates.

6. Proceed to the right front tyre, and repeat the procedure in Step 5.
7. Proceed to the right rear tyre, and repeat the procedure in Step 5.
8. Proceed to the left rear tyre, and repeat the procedure in Step 5. The horn sounds twice to indicate the sensor identification code has been matched, and the tyre pressure sensor matching process is no longer active.
9. Turn off the ignition.
10. Set all four tyres to the recommended inflation pressure ↗ 212.

Tread depth

Check tread depth at regular intervals.

Tyres should be replaced for safety reasons at a tread depth of 2-3 mm (4 mm for winter tyres).

For safety reasons it is recommended that the tread depth of the tyres on one axle should not vary by more than 2 mm.



The legally permissible minimum tread depth (1.6 mm) has been reached when the tread has worn down as far as one of the tread wear indicators (TWI). Their position is indicated by markings on the sidewall.

If there is more wear at the front than the rear, swap round front wheels and rear wheels. Ensure that the direction of rotation of the wheels is the same as before.

Tyres age, even if they are not used. We recommend tyre replacement every 6 years.

Changing tyre and wheel size

If tyres of a different size than those fitted at the factory are used, it may be necessary to reprogramme the speedometer as well as the nominal tyre pressure and make other vehicle modifications.

After converting to a different tyre size, have the label with tyre pressures replaced.

⚠ Warning

Use of unsuitable tyres or wheels may lead to accidents and will invalidate the vehicle type approval.

If wheel rims of a different type are to be installed, the wheel nuts may also need to be changed. We recommend you consult a workshop.

Wheel covers

Wheel covers and tyres that are factory approved for the respective vehicle and comply with all of the relevant wheel and tyre combination requirements must be used.

If the wheel covers and tyres used are not factory approved, the tyres must not have a rim protection ridge.

Wheel covers must not impair brake cooling.

⚠ Warning

Use of unsuitable tyres or wheel covers could lead to sudden pressure loss and thereby accidents.

Tyre chains



Tyre chains are only permitted on the front wheels.

They must be fitted to the tyres symmetrically in order to achieve a concentric fit.

⚠ Warning

Damage may lead to tyre blowout.

Special snow chains are only permitted when they are designed with a rotating chain belt on the tyre tread, no chain links on the wheel inboard sides and the chains add no

more than 12 mm to the tyre tread. For further information regarding correct snow chain usage for the tyre size, contact a specialised vehicle parts dealer or snow chain manufacture. Tyre chains are only permitted on tyres of size 235/60 R17 and 235/55 R18.

General

The use of tyre chains is not permitted on the temporary spare wheel.

Tyre repair kit

Minor damage to the tyre tread or sidewall can be repaired with the tyre repair kit.

Do not remove foreign bodies from the tyres.

Tyre damage exceeding 4 mm or that is at the tyre's sidewall near the rim cannot be repaired with the tyre repair kit.

In vehicles with a tyre repair kit, there may not be a jack and vehicle tool kit.

Vehicle tools ⇨ 179.

Temporary spare wheel ⇨ 193.

Warning

Do not drive faster than 80 km/h.
Do not use for a lengthy period.
Steering and handling may be affected.

If you have a flat tyre:

Apply the electrical parking brake
⇨ 143 and engage first gear, reverse gear or **P**.

The tyre repair kit is in a storage compartment below the floor cover in the load compartment.

To remove the tyre repair kit, open the tailgate.

Pull the floor cover handle upwards
⇨ 68.

Vehicle tools ⇨ 179.

Caution

Do not allow objects to protrude above the top of the rear floor storage compartment, to avoid damage to the storage area and the load compartment floor.

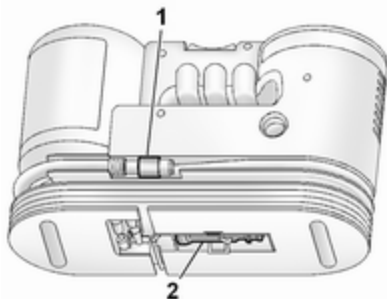

1. Release the sealant filler hose 1 and the power plug 2.
2. Unscrew valve cap from defective tyre.
Screw the sealant filler hose onto the tyre valve.
3. Connect the power plug to the power outlet. Unplug all items from other power outlets.
4. Switch on ignition. To avoid discharging the battery, we recommend running the engine.

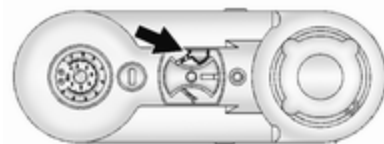

5. Turn the selector switch anticlockwise to the **sealant + air** position.

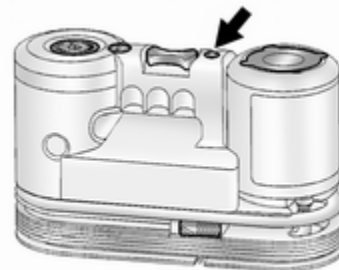

6. Press the **on/off** button to turn the tyre repair kit on. The tyre is filled with sealant.

The pressure gauge briefly shows a high pressure while the sealant canister is emptying. Then the pressure starts to drop.

All of the sealant is pumped into the tyre. Then the tyre is inflated.

7. Inflate the tyre to the recommended inflation pressure using the pressure gauge. The prescribed tyre pressure should be obtained within 10 minutes ↷ 212. When the correct pressure is obtained, switch off the compressor.

If the prescribed tyre pressure is not obtained within 10 minutes, remove the tyre repair kit. Move the vehicle one tyre rotation. Reattach the tyre repair kit and continue the filling procedure for 10 minutes. If the prescribed tyre pressure is still not obtained, the tyre is too badly damaged. Seek the assistance of a workshop.

Drain excess tyre pressure with the button next to the pressure gauge.

Do not run the compressor for longer than 10 minutes.

8. Detach the tyre repair kit and replace the tyre valve cap.
9. Remove any excess sealant using a cloth.



10. Take the label indicating maximum permitted speed from the sealant canister and affix in the driver's field of view.
11. Continue driving immediately so that sealant is evenly distributed in the tyre. After driving approx.

10 km (but no more than 10 minutes) stop and check tyre pressure.

If the tyre pressure has fallen slightly, set it to the correct value. Repeat the procedure until there is no more loss of pressure.

If the tyre pressure has fallen by more than 68 kPa (0.68 bar), the vehicle must not be driven. Seek the assistance of a workshop.

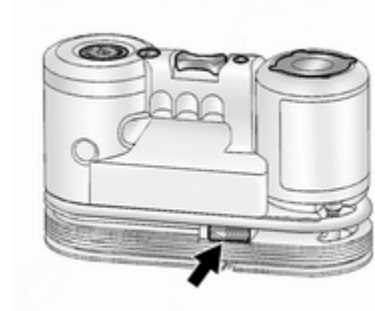

12. To adjust tyre pressure, screw compressor air hose (arrowed) directly onto tyre valve.

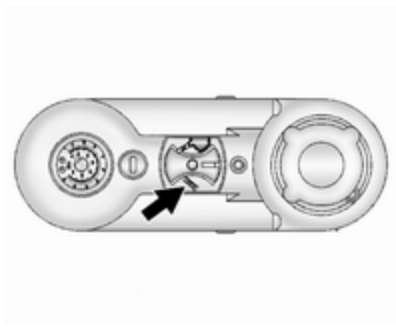

13. Turn the selector switch clockwise to the **air only** position. Switch on the compressor to inflate the tyre with air only.

Note

The driving characteristic of the repaired tyre is severely affected, therefore have this tyre replaced.

If unusual noise is heard or the compressor becomes hot, turn compressor off for at least 30 minutes.

Note the expiry date of the kit. After this date its sealing capability is no longer guaranteed. Pay attention to storage information on sealant canister.

Replace the used sealant canister. To remove sealant canister, release sealant filler hose and air hose, slide canister out of housing and unscrew hose from canister. Dispose of the canister as prescribed by applicable laws.

The accessory adapter supplied can be used to pump up other items e.g. footballs, air mattresses, inflatable dinghies etc. The adapter is located on the underside of the tyre repair kit.

Wheel changing

Some vehicles are equipped with a tyre repair kit instead of a spare wheel ⇨ 187.

Make the following preparations and observe the following information:

- Park the vehicle on a level, firm and non-slippery surface. The front wheels must be in the straight-ahead position.
- Apply the electrical parking brake ⇨ 143 and engage first gear, reverse gear or **P**.
- Remove the spare wheel ⇨ 193.

- Never change more than one wheel at a time.
- Block wheel diagonally opposite the wheel to be changed, by placing wedge blocks or equivalent in front and behind the wheel.
- Use the jack only to change wheels in case of puncture, not for seasonal winter or summer tyre changes.
- Never exceed jack maximum working load (900 kg).
- If the ground on which the vehicle is standing is soft, a solid board (max. 1 cm thick) should be placed under the jack.
- Do not raise the vehicle more than is necessary to change a wheel.
- No people or animals may be in the vehicle when it is jacked-up.
- Never crawl under a jacked-up vehicle.

- Do not start the engine when it is raised on the jack.
- Clean wheel nuts and thread before mounting the wheel.

⚠ Warning

Do not grease wheel bolt, wheel nut and wheel nut cone.

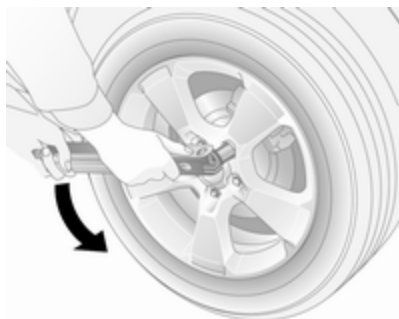

1. Pull off the wheel cover.
2. Install the wheel wrench ensuring that it locates securely and loosen each wheel nut by one turn by turning anticlockwise.

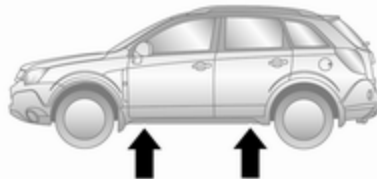

3. The location of front and rear jacking points is indicated by notches on the bottom edge of the vehicle, under the doors.

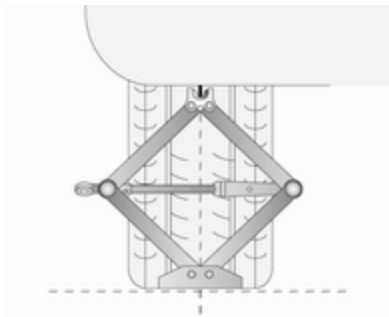

4. Before positioning the jack, set it to the necessary height by rotating the eye by hand.

Position jack at the jacking point located nearest to the wheel concerned so that the jack claw spans the vertical base. Ensure the jack is positioned correctly.

The jack base must be on the ground directly below the jacking point in a manner that prevents it from slipping.

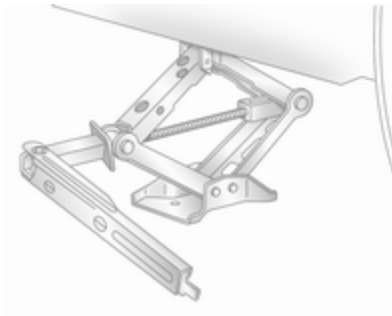

5. Attach wheel wrench to eye of threaded rod and rotate wrench clockwise to raise vehicle.

If this is not the case, carefully lower the vehicle immediately and reposition the jack. Raise the vehicle until the wheel is just clear of the ground.

6. Unscrew wheel nuts completely and wipe clean with a cloth. Do not grease the threads. Put wheel nuts somewhere where the threads will not be soiled.
7. Change the wheel. Notes on spare wheel ⇨ 193.
8. Screw on the wheel nuts and tighten slightly by hand by turning clockwise until wheel is held against the hub.
9. Rotate wrench anticlockwise and lower vehicle to the ground.



10. Install the wheel wrench ensuring that it locates securely and tighten each wheel nut in a crosswise sequence. Tightening torque is 140 Nm.
11. Stow the replaced wheel ⇨ 193 and the vehicle tools ⇨ 179.
12. Check the tyre pressure of the installed tyre as soon as possible. Have the defective tyre renewed and replace temporary spare wheel with a full specification wheel without delay.

Jacking position for lifting platform

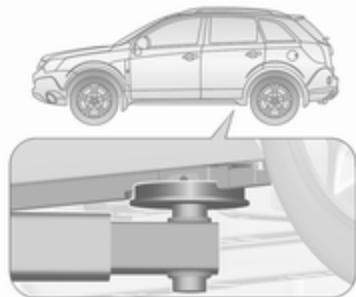

Rear arm position of the lifting platform centrally under the recess of the sill.



Front arm position of the lifting platform centrally under the recess of the sill.

Spare wheel

Temporary spare wheel

Some vehicles are equipped with a tyre repair kit instead of a spare wheel.

The temporary spare wheel is designed for use on your vehicle only.

If mounting a spare wheel which is different from the other wheels, this wheel might be classified as a temporary spare wheel and the corresponding speed limits apply, even though no label indicates this. Seek the assistance of a workshop to check the applicable speed limit.

Use of the temporary spare wheel could affect driveability, particularly if using winter tyres. Have the defective tyre renewed as soon as possible and have the wheel balanced and fitted to the vehicle.

Caution

The use of a spare wheel that is smaller than the other wheels or in combination with winter tyres could affect driveability. Have the defective tyre replaced as soon as possible.

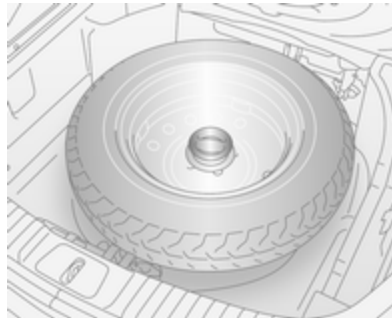

The temporary spare wheel is located in the load compartment below the floor cover and is secured with a screw-in retainer.

Push both levers on the floor cover towards the handle and pull up the cover by the handle. Hang the hook to the upper part of the tailgate opening.

Vehicle tools ⇨ 179.

Remove the retainer by rotating it anticlockwise and remove temporary spare wheel from the spare wheel well.

Only mount one temporary spare wheel. Do not drive faster than 80 km/h. Take curves slowly. Do not use for a long period of time.

When the temporary spare wheel is fitted, do not take the vehicle through an automatic vehicle wash with guide rails. The temporary spare wheel may get caught on the rails, causing damage to the tyre, wheel and other vehicle parts.

The use of tyre chains is not permitted on the temporary spare wheel.

Tyre chains ⇨ 187.

Directional tyres

Fit directional tyres such that they roll in the direction of travel. The rolling direction is indicated by a symbol (e.g. an arrow) on the sidewall.

The following applies to tyres fitted opposing the rolling direction:

- Driveability may be affected. Have the defective tyre renewed or repaired as soon as possible and fit it instead of the spare wheel.
- Do not drive faster than 80 km/h.
- Drive particularly carefully on wet and snow-covered road surfaces.

Warning

Storing a jack, a wheel or other equipment in the load compartment could cause injury if they are not fixed in place properly. During a sudden stop or a collision, loose equipment could cause personal injury or damage to the vehicle.

Always store the jack and vehicle tools in their respective storage compartments and secure them properly.

Always place the damaged wheel in the load compartment, secured in the spare wheel well with the screw-in retainer.

Jump starting

Do not start with quick charger.

A vehicle with a discharged battery can be started using jump leads and the battery of another vehicle.

Warning

Be extremely careful when starting with jump leads. Any deviation from the following instructions can lead to injuries or damage caused by battery explosion or damage to the electrical systems of both vehicles.

Warning

Avoid contact of the battery with eyes, skin, fabrics and painted surfaces. The fluid contains sulphuric acid which can cause injuries and damage in the event of direct contact.

- Never expose the battery to naked flames or sparks.

- A discharged battery can already freeze at a temperature of 0 °C. Defrost the frozen battery before connecting jump leads.
- Wear eye protection and protective clothing when handling a battery.
- Use a booster battery with the same voltage (12 Volts). Its capacity (Ah) must not be much less than that of the discharged battery.
- Use jump leads with insulated terminals and a cross section of at least 16 mm² (25 mm² for diesel engines).
- Do not disconnect the discharged battery from the vehicle.
- Switch off all unnecessary electrical consumers. The Infotainment system may be damaged if switched on while jump starting.
- Do not lean over the battery during jump starting.
- Do not allow the terminals of one lead to touch those of the other lead.

- The vehicles must not come into contact with each other during the jump starting process.
- Apply the electrical parking brake
 ⇨ 143, transmission in neutral, automatic transmission in **P**.
- Open the positive terminal protection caps of both batteries.

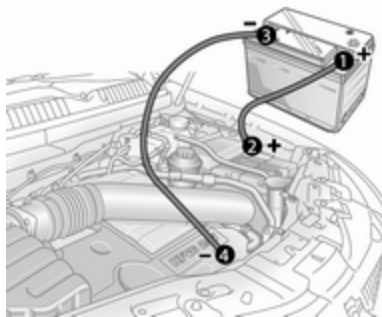

Lead connection order:

1. Connect the red lead to the positive terminal **1** of the booster battery.
2. Connect the other end of the red lead to the positive terminal **2** of the discharged battery.

3. Connect the black lead to the negative terminal **3** of the booster battery.
4. Connect the other end of the black lead to a vehicle grounding point, such as the engine block **4** or an engine mounting bolt. Connect as far away from the discharged battery as possible, however at least 60 cm.

Route the leads so that they cannot catch on rotating parts in the engine compartment.

To start the engine:

1. Start the engine of the vehicle providing the jump start.
2. After 5 minutes, start the other engine. Start attempts should be made for no longer than 15 seconds at an interval of 1 minute.
3. Allow both engines to idle for approx. 3 minutes with the leads connected.
4. Switch on electrical consumers (e.g. headlights, heated rear window) of the vehicle receiving the jump start.

5. Operate discharged vehicle for approx. 20 minutes to allow for adequate battery recharging.
6. Reverse above sequence exactly when removing leads.

Towing

Towing the vehicle

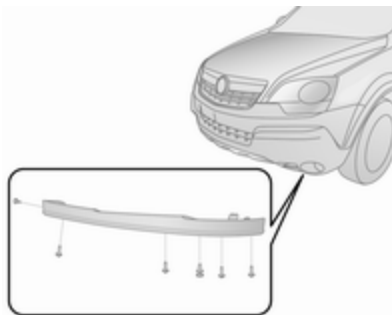

Remove the spoiler lip from the front left-hand side of the vehicle by unfastening the six screws located on the underside of the vehicle. Then attach the towing eye.

The towing eye is stowed with the vehicle tools ↗ 179.

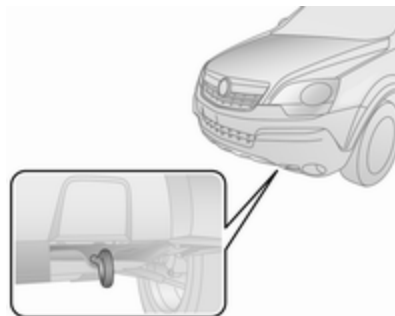

Screw in the towing eye as far as it will go until it stops in a horizontal position.

Attach a tow rope - or better still a tow rod - to the front towing eye, never to the bumper or front suspension units.

Do not tow the vehicle from the rear. The front towing eye must only be used for towing and not recovering a vehicle.

Switch on ignition to release steering wheel lock and to permit operation of brake lights, horn and windscreen wiper.

Transmission in neutral.

Turn key to ignition switch position **ACC** and release the electrical parking brake before towing the vehicle.

Caution

Drive slowly. Do not drive jerkily. Excessive tractive force can damage the vehicle.

When the engine is not running, considerably more force is needed to brake and steer.

Keep tow rope clear of front bumper, and ensure it is securely fixed to the towing eye at both ends. Pull on the tow rope to check.

To prevent the entry of exhaust gases from the towing vehicle, switch on the air recirculation system ↻ 115 and close the windows.

Vehicles with manual transmission: The vehicle must be towed facing forwards. The maximum speed is 88 km/h. In all other cases, and when the transmission is defective, the front axle must be raised off the ground.

Vehicles with automatic transmission: Do not tow the vehicle using the towing eye. Towing with a tow rope could cause severe damage to the transmission. When towing a vehicle with automatic transmission, use flat bed or wheel lift equipment.

Seek the assistance of a workshop. After towing, unscrew the towing eye and replace the spoiler lip. Store towing eye in the storage compartment below the floor cover in the load compartment.

Vehicle tools ↻ 179.

Towing another vehicle

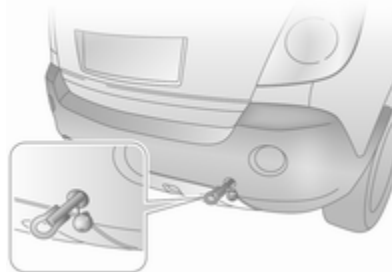

Remove the cover located on the rear bumper by pressing the lower part of the cover.

The rear towing eye attachment is stored below the floor cover in the load compartment.

Screw the rear towing eye attachment anticlockwise using a suitable screwdriver, until it is firmly in place and stops in a horizontal position.

Attach a tow rope – or better still a tow rod – to the rear towing eye.

The towing eye must only be used for towing and not for recovering a vehicle.

Caution

Drive slowly. Do not drive jerkily. Excessive tractive force can damage the vehicle.

To prevent damage, do not take up slack in the tow rope too quickly.

After towing, unscrew the rear towing eye attachment clockwise to remove, and reinstall the cover.

Appearance care

Exterior care

Locks

The locks are lubricated at the factory using a high quality lock cylinder grease. Use de-icing agent only when absolutely necessary, as this has a degreasing effect and impairs lock function. After using a de-icing agent, have the locks regreased by a workshop.

Washing

The paintwork of your vehicle is exposed to environmental influences. Wash and wax your vehicle regularly. When using automatic car washes, select a programme that includes waxing.

Bird droppings, dead insects, resin, pollen and the like should be cleaned off immediately, as they contain aggressive constituents which can cause paint damage.

If using a car wash, comply with the car wash manufacturer's instructions. The windscreen wiper and rear window wiper must be switched off. Remove antenna and external accessories such as roof racks etc.

If you wash your vehicle by hand, make sure that the insides of the wheel housings are also thoroughly rinsed out.

Clean edges and folds on opened doors and the bonnet as well as the areas they cover.

Caution
<p>Always use a cleaning agent with a pH value of 4 to 9.</p> <p>Do not use cleaning agents on hot surfaces.</p>

Have the door hinges of all doors greased by a workshop.

Do not clean the engine compartment with a steam-jet or high-pressure jet cleaner.

When cleaning with a high-pressure jet cleaner, ensure a minimum distance of 30 cm when working around the tailgate to prevent unintended unlocking.

Thoroughly rinse and leather-off the vehicle. Rinse leather frequently. Use separate leathers for painted and glass surfaces: remnants of wax on the windows will impair vision.

Do not use hard objects to remove spots of tar. Use tar removal spray on painted surfaces.

Exterior lights

Headlight and other light covers are made of plastic. Do not use any abrasive or caustic agents, do not use an ice scraper, and do not clean them dry.

Polishing and waxing

Wax the vehicle regularly (at the latest when water no longer beads). Otherwise, the paintwork will dry out. Polishing is necessary only if the paint has become dull or if solid deposits have become attached to it.

Paintwork polish with silicone forms a protective film, making waxing unnecessary.

Plastic body parts must not be treated with wax or polishing agents.

Windows and windscreen wiper blades

Use a soft lint-free cloth or chamois leather together with window cleaner and insect remover.

When cleaning the rear window, make sure the heating element inside is not damaged.

For mechanical removal of ice, use a sharp-edged ice scraper. Press the scraper firmly against the glass so that no dirt can get under it and scratch the glass.

Clean smearing wiper blades with a soft cloth and window cleaner.

Sunroof

Never clean with solvents or abrasive agents, fuels, aggressive media (e.g. paint cleaner, acetone-containing solutions etc.), acidic or highly alkaline media or abrasive pads. Do not apply wax or polishing agents to the sunroof.

Wheels and tyres

Do not use high-pressure jet cleaners.

Clean rims with a pH-neutral wheel cleaner.

Rims are painted and can be treated with the same agents as the body.

Paintwork damage

Rectify minor paintwork damage with a touch-up pen before rust forms. Have more extensive damage or rust areas repaired by a workshop.

Underbody

Some areas of the vehicle underbody have a PVC undercoating while other critical areas have a durable protective wax coating.

After the underbody is washed, check the underbody and have it waxed if necessary.

Bitumen/rubber materials could damage the PVC coating. Have underbody work carried out by a workshop.

Before and after winter, wash the underbody and have the protective wax coating checked.

Towing equipment

Do not clean the coupling ball bar with a steam-jet or high-pressure jet cleaner.

Rear carrier system

Clean the rear carrier system with a steam-jet or high-pressure jet cleaner at least once a year.

Operate the rear carrier system once in a while if not in regular use, in particular during winter.

Interior care

Interior and upholstery

Only clean the vehicle interior, including the instrument panel fascia and panelling, with a dry cloth or interior cleaner.

Clean the leather upholstery with clear water and a soft cloth. In case of heavy soiling, use leather care.

The instrument cluster and the displays should only be cleaned using a soft damp cloth. If necessary use a weak soap solution.

Clean fabric upholstery with a vacuum cleaner and brush. Remove stains with an upholstery cleaner.

Clothing fabrics may not be colourfast. This could cause visible discolourations, especially on light-coloured upholstery. Removable stains and discolourations should be cleaned as soon as possible.

Clean seat belts with lukewarm water or interior cleaner.

Caution
Close Velcro fasteners as open Velcro fasteners on clothing could damage seat upholstery. The same applies to clothing with sharp-edged objects, like zips or belts or studded jeans.

Plastic and rubber parts

Plastic and rubber parts can be cleaned with the same cleaner as used to clean the body. Use interior cleaner if necessary. Do not use any other agent. Avoid solvents and petrol in particular. Do not use high-pressure jet cleaners.

Service and maintenance

General information 201
 Service information 201

Recommended fluids, lubricants and parts 202
 Recommended fluids and lubricants 202

General information

Service information

In order to ensure economical and safe vehicle operation and to maintain the value of your vehicle, it is of vital importance that all maintenance work is carried out at the proper intervals as specified.

The detailed, up-to-date service schedule for the vehicle is available at the workshop.

Service display ⇨ 80.

European service intervals

Main service

Maintenance of your vehicle is required every 30,000 km or after 1 year, whichever occurs first, unless otherwise indicated in the service display.

A shorter service interval can be valid for severe driving behaviour, e.g. for taxis and police vehicles.

The European service intervals are valid for the following countries:

Andorra, Austria, Belgium, Bosnia-Herzegovina, Bulgaria, Croatia, Cyprus, Czech Republic, Denmark, Estonia, Finland, France, Germany, Greece, Greenland, Hungary, Iceland, Ireland, Italy, Latvia, Lithuania, Luxembourg, Macedonia, Malta, Montenegro, Netherlands, Norway, Poland, Portugal, Romania, Serbia, Slovakia, Slovenia, Spain, Sweden, Switzerland, United Kingdom.

Service display ⇨ 80.

International service intervals

Main service

Maintenance of your vehicle is required every 15,000 km or 1 year, whichever occurs first, unless otherwise indicated in the service display.

The international service intervals are valid for the countries which are not listed in the European service intervals.

Service display ⇨ 80.

Confirmations

Confirmation of service is recorded in the Service and warranty booklet. The date and mileage is completed with the stamp and signature of the servicing workshop.

Make sure that the Service and warranty booklet is completed correctly as continuous proof of service is essential if any warranty or goodwill claims are to be met, and is also a benefit when selling the vehicle.

Service interval with remaining engine oil life duration

The service interval is based on several parameters depending on usage.

The service display lets you know when to change the engine oil.

Service display ⇨ 80.

Recommended fluids, lubricants and parts

Recommended fluids and lubricants

Only use products that meet the recommended specifications.

Warning

Operating materials are hazardous and could be poisonous. Handle with care. Pay attention to information given on the containers.

Engine oil

Engine oil is identified by its quality and its viscosity. Quality is more important than viscosity when selecting which engine oil to use. The oil quality ensures e.g. engine cleanliness, wear protection and oil ageing control, whereas viscosity grade gives information on the oil's thickness over a temperature range.

Dexos is the newest engine oil quality that provides optimum protection for diesel engines. If it is unavailable, engine oils of other listed qualities have to be used.

Select the appropriate engine oil based on its quality and on the minimum ambient temperature ⇨ 206.

Topping up engine oil

Engine oils of different manufacturers and brands can be mixed as long as they comply with the required engine oil quality and viscosity.

Use of engine oil with only ACEA A1/B1 or only A5/B5 quality is prohibited, since it can cause long-term engine damage under certain operating conditions.

Select the appropriate engine oil based on its quality and on the minimum ambient temperature ⇨ 206.

Additional engine oil additives

The use of additional engine oil additives could cause damage and invalidate the warranty.

Engine oil viscosity

The SAE viscosity grade gives information of the thickness of the oil.

Multigrade oil is indicated by two figures, e.g. SAE 5W-30. The first figure, followed by a W, indicates the low temperature viscosity and the second figure the high temperature viscosity.

Select the appropriate viscosity grade depending on the minimum ambient temperature ↗ 206.

All of the recommended viscosity grades are suitable for high ambient temperatures.

Coolant and antifreeze

Use only silicate-free long life coolant (LLC) antifreeze. Consult a workshop.

The system is factory filled with coolant designed for excellent corrosion protection and frost protection down to approx. -28 °C. In northern countries with very low temperatures the factory filled coolant provides frost protection down to approx. -37 °C. This concentration

should be maintained all year round. The use of additional coolant additives that intend to give additional corrosion protection or seal against minor leaks can cause function problems. Liability for consequences resulting from the use of additional coolant additives will be rejected.

Brake and clutch fluid

Over time, brake fluid absorbs moisture which will reduce braking effectiveness. The brake fluid should therefore be replaced at the specified interval.

AdBlue

Only use AdBlue to reduce the nitrogen oxides in the exhaust emission ↗ 131.

Technical data

Vehicle identification	204
Vehicle Identification Number ..	204
Identification plate	205
Engine identification	205
Vehicle data	206
Recommended fluids and lubricants	206
Engine data	207
Performance	208
Vehicle weight	209
Vehicle dimensions	209
Capacities	211
Tyre pressures	212

Vehicle identification

Vehicle Identification Number



The Vehicle Identification Number is visible through the windscreen.

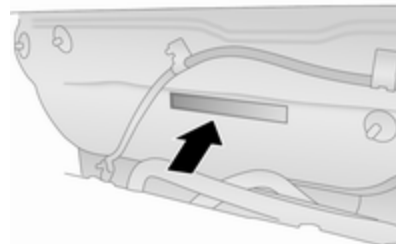

The Vehicle Identification Number is also engraved on the top right-hand side of the bulkhead near the centre of the engine firewall.

Identification plate



The identification label is located on the front left door frame.

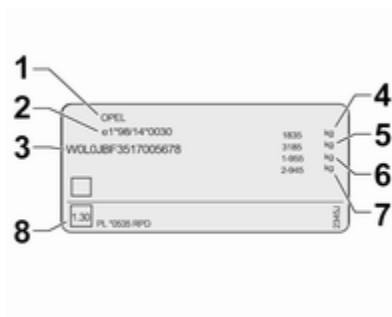

Information on identification label:

- 1 : Manufacturer
- 2 : Type approval number
- 3 : Vehicle Identification Number
- 4 : Permissible gross vehicle weight rating in kg
- 5 : Permissible gross train weight in kg
- 6 : Maximum permissible front axle load in kg
- 7 : Maximum permissible rear axle load in kg
- 8 : Vehicle-specific or country-specific data

The combined total of front and rear axle loads must not exceed the permissible gross vehicle weight. For example, if the front axle is bearing its maximum permissible load, the rear axle can only bear a load that is equal to the gross vehicle weight minus the front axle load.

The technical data is determined in accordance with European Community standards. We reserve the right to make modifications. Specifications in the vehicle documents always have priority over those given in this manual.

Engine identification

The technical data tables show the engine identifier code. Engine data ⇨ 207.

To identify the respective engine, refer to the engine power in the EEC Certificate of Conformity provided with your vehicle or other national registration documents.

Vehicle data

Recommended fluids and lubricants

Required engine oil quality

Engine oil quality: Europe

dexos 2 ✓

In case dexos quality is unavailable you may use max. 1 litre engine oil quality ACEA C3 once between each oil change.

For countries with International service interval ⇨ 201, you may use the oil qualities listed below:

Engine oil quality: International

dexos 2 ✓

GM-LL-B-025 ✓

ACEA A3/B4 ✓

ACEA C3 ✓

Engine oil viscosity grades

Ambient temperature

down to -25 °C SAE 5W-30 or
SAE 5W-40

below -25 °C SAE 0W-30 or
SAE 0W-40

For countries with International service interval ⇨ 201, you may also use the oil viscosity grades listed below:

Ambient temperature

down to -20 °C SAE 10W-30¹⁾ or
SAE 10W-40¹⁾

1) Permitted, but usage of SAE 5W-30 or SAE 5W-40 with dexos quality is recommended.

Engine data

Sales designation	2.0 CDTI	2.2 CDTI	2.2 CDTI
Engine identifier code	B 20 DTH	A 22 DM	A 22 DMH
Number of cylinders	4	4	4
Piston displacement [cm ³]	1956	2231	2231
Engine power [kW]	125	120	135
at rpm	3750	3800	3800
Torque [Nm]	400	350	400
at rpm	1750-2500	2000	2000
Fuel type	Diesel	Diesel	Diesel

AdBlue ↪ 131.

Performance**All-wheel drive**

Engine	B 20 DTH	A 22 DM	A 22 DMH
Maximum speed [km/h]			
Manual transmission	197	188	200
Automatic transmission	-	182	191

Front-wheel drive

Engine	B 20 DTH	A 22 DM	A 22 DMH
Maximum speed [km/h]			
Manual transmission	195	189	–
Automatic transmission	193	184	–

Vehicle weight

Kerb weight, basic model without any optional equipment

Manual transmission / Automatic transmission.

Engine	All-wheel drive	Front-wheel drive
B 20 DTH	1925-1985 / -	1851-1911 / 1883-1943
A 22 DM	1911-1971 / 1936-1996	1836-1896 / 1861-1921
A 22 DMH	1911-1971 / 1936-1996	- / -

Optional equipment and accessories increase the kerb weight.

Loading information ⇨ 70.

Vehicle dimensions

Length [mm]	4596
Width [mm]	1850
Height with roof rails [mm]	1761
Height without roof rails [mm]	1717
Wheelbase [mm]	2707
Track width [mm]	1569
Front	
Rear	1576

210 Technical data

Turning circle diameter, wall to wall [m]	12.78
---	-------

Turning circle diameter, kerb to kerb [m]	11.87
---	-------

Maximum wading depth [mm] (at 5 km/h)	450
--	-----

Approach angle	20°
----------------	-----

Ramp angle	18°
------------	-----

Departure angle	24°
-----------------	-----

Capacities

Engine oil

Engine	B 20 DTH	A 22 DM	A 22 DMH
including filter [l]	4.9	5.6	5.6
between MIN and MAX [l]	1.0	1.0	1.0

Fuel tank

Diesel, nominal capacity [l]	65
------------------------------	----

AdBlue tank

AdBlue, nominal capacity [l]	12.2
------------------------------	------

Tyre pressures

Engine Tyres	Up to full load		Up to full load ECO		Trailer towing	
	front	rear	front	rear	front	rear
	[kPa/bar] ([psi])	[kPa/bar] ([psi])	[kPa/bar] ([psi])	[kPa/bar] ([psi])	[kPa/bar] ([psi])	[kPa/bar] ([psi])
All 215/70 R 16 ²⁾ , 235/60 R 17, 235/65 R 17, 235/55 R 18, 235/50 R 19	240/2.4 (35)	240/2.4 (35)	260/2.6 (38)	260/2.6 (38)	240/2.4 (35)	280/2.8 (41)

2) Spare wheel.

Customer information

Customer information	213
Declaration of conformity	213
Collision damage repair	215
Vehicle data recording and privacy	215
Event data recorders	215
Radio Frequency Identification (RFID)	216

Customer information

Declaration of conformity

Transmission systems

This vehicle has systems that transmit and/or receive radio waves subject to Directive 1999/5/EC. These systems are in compliance with the essential requirements and other relevant provisions of Directive 1999/5/EC. Copies of the original Declarations of Conformity can be obtained on our website.



GM Korea

GM Korea Company
219-1, Cheongju-ro-2Dong,
Egyang-gu, Seoul, 031724, Korea

Declaration of Conformity

pursuant to Directive 2006/42/EC

We hereby declare that the product:

Product description : Car Jack
Type/Part No. : 13590195

is in conformity with Directive 2006/42/EC.

Technical standards applied:

GMW14337 Standard Equipment Jack - Hardware Tests
GMW15005 Standard Equipment Jack and Spare Tire, Vehicle Test

The person authorized to compile the technical file is:

Hans-Peter Metzger
Adam Opel AG
65423 Rüsselsheim / Germany

Incheon, Republic of Korea, 4 April 2014

Daehyuk An
Engineering Group Manager Tire Wheel Systems
GM Korea

Translation of the original declaration of conformity

Declaration of conformity according to EC Directive 2006/42/EC

We declare that the product:

Product designation: Jack

Type/GM part number: 13590195

is in compliance with the provisions of Directive 2006/42/EC.

Applied technical standards:

GMW 14337 : Standard Equipment
Jack – Hardware
Tests

GMW15005 : Standard Equipment
Jack and Spare Tyre,
Vehicle Test

The person authorised to compile the technical documentation is

Hans-Peter Metzger

Engineering Group Manager Chassis
& Structure

Adam Opel AG

D-65423 Rüsselsheim

Signed by

Daehyeok An

Engineering Group Manager Tyre
Wheel Systems

GM Korea

Bupyung, Incheon, 403-714, Korea
Incheon, Republic of Korea, 4th April
2014

Collision damage repair**Paint thickness**

Due to production techniques, the thickness of the paint can vary between 50 and 400 µm.

Therefore, different paint thickness is no indicator for a collision damage repair.

Vehicle data recording and privacy**Event data recorders****Data storage modules in the vehicle**

A large number of electronic components of your vehicle contain data storage modules temporarily or permanently storing technical data about the condition of the vehicle, events and errors. In general, this technical information documents the condition of parts, modules, systems or the environment:

- Operating conditions of system components (e.g. filling levels)
- Status messages of the vehicle and its single components (e.g. number of wheel revolutions / rotational speed, deceleration, lateral acceleration)
- Dysfunctions and defects in important system components

- Vehicle reactions in particular driving situations (e.g. inflation of an airbag, activation of the stability regulation system)
- Environmental conditions (e.g. temperature)

These data are exclusively technical and help identifying and correcting errors as well as optimizing vehicle functions.

Motion profiles indicating travelled routes cannot be created with these data.

If services are used (e.g. repair works, service processes, warranty cases, quality assurance), employees of the service network (manufacturer included) are able to read out this technical information from the event and error data storage modules applying special diagnostic devices. If required, you will receive further information at these workshops. After an error has been corrected, the data are deleted from the error storage module or they are constantly overwritten.

When using the vehicle, situations may occur in which these technical data related to other information (accident report, damages on the vehicle, witness statements etc.) may be associated with a specific person - possibly with the assistance of an expert.

Additional functions contractually agreed upon with the client (e.g. vehicle location in emergency cases) allow the transmission of particular vehicle data from the vehicle.

Radio Frequency Identification (RFID)

RFID technology is used in some vehicles for functions such as tyre pressure monitoring and ignition system security. It is also used in connection with conveniences such as radio remote controls for door locking/unlocking and starting, and in-vehicle transmitters for garage door openers. RFID technology in Opel vehicles does not use or record personal information or link with any other Opel system containing personal information.

Index

A

Accessories and vehicle modifications	157
Accessory sockets.....	77
Active head restraints.....	35, 36
AdBlue.....	88, 131
Adjustable air vents	119
Airbag and belt tensioners	83
Airbag deactivation	50, 83
Airbag label.....	45
Airbag system	45
Air conditioning regular operation	121
Air conditioning system	115
Air intake	120
Air vents.....	119
All wheel drive	86, 140
Antilock brake system	142
Antilock brake system (ABS)	85
Anti-theft alarm system	26, 91
Anti-theft locking system	25
Appearance care.....	198
Apply footbrake	90
Armrest.....	39, 41
Armrest storage	58
Automatic anti-dazzle	30
Automatic dimming	30
Automatic headlight levelling system	90
Automatic level control.....	106, 147

Automatic light control	106
Automatic transmission.....	84, 136
Autostop.....	126
AUX input.....	58

B

Battery.....	84
Battery discharge protection	113
Battery, jump starting.....	194
Belt pretensioners.....	41
Belts.....	41
Bicycle rack.....	58
BlueInjection.....	131
Board-Info-Display	92
Bonnet	158
Brake and clutch fluid.....	202
Brake assist	144
Brake fluid	162
Brakes	142, 161
Brake system	85
Breakdown.....	196
Bulb replacement	165

C

Capacities	211
Card holder.....	56
Car Pass	21
Catalytic converter.....	84, 130
CD tray.....	56
Central locking system	22
Centre console storage	58

Centre high-mounted brake light.....	109, 170
Change engine oil	89
Changing tyre and wheel size ...	186
Charging system	84
Check control.....	99
Child locks	23
Child restraint installation locations	52
Child restraints.....	51
Child restraint systems	51
Cleaning the vehicle.....	198
Climate control	15
Climate control systems.....	114
Clock	75
Clutch fluid.....	162
Coin storage.....	56
Collision damage repair.....	215
Console box.....	58
Console net.....	56
Control indicators.....	80
Control of the vehicle	123
Controls.....	72
Controls in steering wheel.....	72
Convex shape	28
Coolant and antifreeze.....	202
Coupling ball bar.....	153
Cruise control	91, 147
Cupholders	57
Curtain airbag system	49

D

Danger, Warnings and Cautions ...	4
Daytime running lights	107
Declaration of conformity.....	213
DEF.....	131
Descent control system	86, 146
Diesel exhaust fluid.....	131
Diesel fuel filter	164
Diesel fuel system bleeding	165
Diesel particle filter.....	84, 88, 129
Door open	91
Doors.....	24
Drain fuel filter	90
Drink holders.....	57
Driver assistance systems.....	147
Driver Information Centre.....	91
Driving characteristics and towing tips	152
Driving economically.....	122
Driving hints.....	122, 123

E

Electric adjustment	28
Electrical parking brake.....	85, 143
Electrical parking brake fault.....	85
Electrical system.....	171
Electric power steering.....	124
Electronic climate control system	116
Electronic driving programmes ..	138
Electronic Stability Control ..	87, 145

Electronic Stability Control off.....	87
End-of-life vehicle recovery	158
Engine compartment fuse box ...	173
Engine coolant	160
Engine coolant temperature	87
Engine data	207
Engine exhaust	129
Engine identification.....	205
Engine oil	159, 202, 206
Engine oil life monitor.....	89
Engine oil pressure	88
Entry lighting	112
Event data recorders.....	215
Exhaust gases.....	129
Exit lighting	112
Exterior care	198
Exterior lighting	13, 105
Exterior mirrors.....	28

F

Fault	138
Fire extinguisher.....	69
First aid kit	69
Fixed air vents	120
Flex-Fix system.....	58
Fog light	90
Fog lights.....	108, 109, 168
Folding mirrors	29
Front airbag system	48
Front fog lights	108

Front passenger seat undertray... 57
Front seats..... 36
Fuel consumption - CO ₂ -
Emissions 151
Fuel economy mode..... 89, 122
Fuel filler cap..... 84
Fuel for diesel engines 150
Fuel gauge 79
Fuses 171

G

Gauges..... 78
General information 152
Glovebox 57
Graphic-Info-Display, Colour- Info-Display 94

H

Halogen headlights 166
Hand brake..... 143
Hazard warning flashers 107
Headlight flash 106
Headlight range adjustment 106
Headlights..... 105, 106, 165
Headlights when driving abroad 107
Headlight washer..... 73
Head restraint adjustment 8
Head restraints 35
Heated mirrors 29
Heated rear window 32
Heating 40

Heating and ventilation system . 114
High beam 90, 106
Hill start assist 144
Horn 14, 72

I

Identification plate 205
Ignition switch positions 125
Immobiliser 28, 90
Indicators..... 78
Information displays..... 91
Initial drive information..... 6
Instrument cluster 78
Instrument panel fuse box 176
Instrument panel illumination 171
Instrument panel illumination control 110
Instrument panel overview 10
Instrument panel storage..... 56
Interior care 200
Interior lighting..... 110
Interior lights 110, 170
Interior mirrors..... 30
Interruption of power supply 139
Introduction 3
ISOFIX child restraint systems 55

J

Jump starting 194

K

Kerb weight..... 70, 209
Keys 20
Keys, locks..... 20
Kickdown..... 138

L

Lashing eyes 69
Light covers, misted..... 109
Lighting..... 105
Lighting features..... 112
Light switch 105
Load compartment 24, 67
Load compartment cover 67
Load compartment lighting..... 111
Load compartment storage..... 67
Loading information 70
Low engine oil level 89
Low fuel 89

M

Malfunction indicator light 84
Manual anti-dazzle 30
Manual mode 138
Manual transmission 139
Mirror adjustment 9
Mirrors..... 28, 30
Misted light covers 109

- N**
 New vehicle running-in 124
 Number plate light 170
- O**
 Object detection systems..... 148
 Odometer 78
 Oil..... 159
 Oil, engine..... 202, 206
 Oil life monitor..... 89
 Outside temperature 75
 Overrun cut-off 126
- P**
 Parking 18, 128
 Parking assist 148
 Parking brake..... 85, 143
 Parking lights 109
 Particulate filter..... 129
 Performance 208
 Performing work 158
 Pollen filter 120
 Power outlets..... 58, 77
 Power seat adjustment..... 39
 Power steering..... 86, 124
 Power steering fluid..... 161
 Power windows 31
 Preheating 87
 Puncture..... 190
- R**
 Radio Frequency Identification
 (RFID)..... 216
 Radio remote control 21
 Rain sensor..... 73
 Reading lights 111
 Rear carrier system..... 58
 Rear floor storage cover 68
 Rear fog light 91
 Rear fog lights 109
 Rear seats 40, 41
 Rear window wiper/washer 74
 Recommended fluids and
 lubricants 202, 206
 Reduced engine power..... 90
 Refuelling 150
 Remote control..... 21
 Reversing lights 109
 Roof..... 33
 Roof load..... 69
 Roof rack 69, 70
- S**
 Safety belts..... 41
 Seat adjustment 6, 37
 Seat belt 8
 Seat belt reminder..... 42, 83
 Seat belts 41
 Seat folding 38
 Seat heating..... 40
 Seat position 36
 Selective catalytic reduction..... 131
 Selector lever 136
 Service 121, 201
 Service display 80, 89
 Service information 201
 Service vehicle soon 84
 Side airbag system 48
 Sidelights..... 105
 Side turn signal lights 170
 Spare wheel 193
 Speedometer 78
 Speed warning..... 91
 Sport mode 86, 137
 Starting and operating..... 124
 Starting off 17
 Starting the engine 125
 Steering..... 124
 Steering wheel adjustment 9, 72
 Steering wheel controls 72
 Stop-start system..... 126
 Storage..... 56
 Storage compartments..... 56
 Sunglasses storage 57
 Sunroof 33
 Sunvisor lights 112
 Sun visors 33
 Symbols 4

T

Tachometer	79
Tailgate.....	24
Tail lights	169
Technical data.....	207
Three-point seat belt	42
Tools	179
Top-tether fastening eyes	55
Tow bar.....	152
Towing.....	152, 196
Towing another vehicle	197
Towing a trailer.....	153
Towing equipment	153
Towing the vehicle	196
Trailer coupling.....	152
Trailer indicator	91
Trailer stability assist	155
Trailer towing	153
Transmission	16
Transmission display	80, 136
Tread depth	186
Trip computer in Board-Info- Display	100
Trip computer in Graphic-Info- Display or Colour-Info-Display	102
Trip odometer	79
Turn and lane-change signals ...	108
Turn signal	83
Tyre chains	187
Tyre changing.....	190

Tyre designations	181
Tyre pressure	99, 182
Tyre pressure monitoring system.....	88, 99, 183
Tyre pressures	212
Tyre repair kit	187
Tyres and wheel size, changing.	186

U

Ultrasonic parking assist	87, 148
Underseat storage	57
Upholstery, cleaning.....	200
Upshift.....	86
Using this manual	3

V

Vehicle battery	162
Vehicle checks.....	158
Vehicle data.....	206
Vehicle data recording and privacy.....	215
Vehicle dimensions	209
Vehicle Identification Number ...	204
Vehicle jack.....	179
Vehicle security.....	25
Vehicle specific data	3
Vehicle storage.....	157
Vehicle tools.....	179
Vehicle unlocking	6
Vehicle weight	209
Ventilation.....	114

W

Warning chimes	99
Warning lights.....	78
Warning triangle	69
Washer and wiper systems	14
Washer fluid	161
Washing the vehicle.....	198
Welcome lighting.....	112
Wheel changing	190
Wheel covers	187
Wheels and tyres	181
Windows.....	31
Windscreen.....	31
Windscreen wiper/washer	73
Winter tyres	181
Wiper blade replacement	165

X

Xenon headlights	167
------------------------	-----

www.opel.com

Copyright by ADAM OPEL AG, Rüsselsheim, Germany.

The information contained in this publication is effective as of the date indicated below. Adam Opel AG reserves the right to make changes to the technical specifications, features and design of the vehicles relative to the information in this publication as well as changes to the publication itself.

Edition: December 2016, ADAM OPEL AG, Rüsselsheim.

Printed on chlorine-free bleached paper.

ID-OANAOBSE1612-en

