

AMPERA-E

Owner's Manual



Contents

Introduction	2
In brief	4
Keys, doors and windows	16
Seats, restraints	37
Storage	57
Instruments and controls	64
Lighting	98
Infotainment system	105
Climate control	141
Driving and operating	147
Vehicle care	209
Service and maintenance	246
Technical data	249
Customer information	254
Index	262

Introduction

Your vehicle is a designed combination of advanced technology, safety, environmental friendliness and economy.

This Owner's Manual provides you with all the necessary information to enable you to drive your vehicle safely and efficiently.

Make sure your passengers are aware of the possible risk of accident and injury which may result from improper use of the vehicle.

You must always comply with the specific laws and regulations of the country that you are in. These laws may differ from the information in this Owner's Manual.

Disregarding the description given in this manual may affect your warranty.

When this Owner's Manual refers to a workshop visit, we recommend your Opel Service Partner.

All Opel Service Partners provide first-class service at reasonable prices. Experienced mechanics trained by Opel work according to specific Opel instructions.

The customer literature pack should always be kept ready to hand in the vehicle.

Using this manual

- This manual describes all options and features available for this model. **Certain descriptions, including those for display and menu functions, may not apply to your vehicle due to model variant, country specifications, special equipment or accessories.**
- The "In brief" section will give you an initial overview.
- The table of contents at the beginning of this manual and within each section shows where the information is located.
- The index will enable you to search for specific information.

- Directional data, e.g. left or right, or front or back, always relate to the direction of travel.
- Displays may not support your specific language.
- Display messages and interior labelling are written in **bold** letters.

Danger, Warnings and Cautions

Danger

Text marked  **Danger** provides information on risk of fatal injury. Disregarding this information may endanger life.

Warning

Text marked  **Warning** provides information on risk of accident or injury. Disregarding this information may lead to injury.

Caution

Text marked **Caution** provides information on possible damage to the vehicle. Disregarding this information may lead to vehicle damage.

Symbols

Page references are indicated with ⇨.
⇨ means "see page".

Page references and index entries refer to the indented headings given in the section table of content.

Chronological order to select menu entries in the vehicle personalisation is indicated with ▶.

We wish you many hours of pleasurable driving.

Your Opel Team

In brief

Initial drive information

Vehicle unlocking



Press  to unlock the doors and load compartment. Open the doors by pulling the handles.

Tailgate



To open the tailgate, push the touchpad switch.

Radio remote control ⇨ 17.

Central locking system ⇨ 20.

Electronic key system ⇨ 19.

Load compartment ⇨ 29.

Seat adjustment

Longitudinal adjustment



Pull handle, slide seat, release handle. Try to move the seat back and forth to ensure that the seat is locked in place.

Backrests inclination



Pull lever, adjust inclination and release lever. Allow the backrest to engage audibly.

Seat height

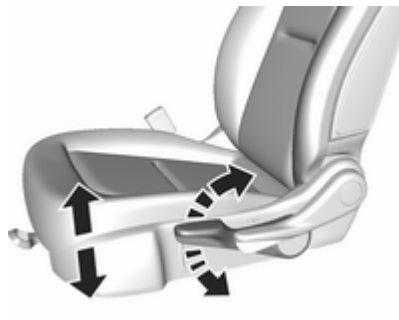

Lever pumping motion
up : seat higher
down : seat lower

Seat position ⇨ 38.

Manual seat adjustment ⇨ 39.

Head restraint adjustment

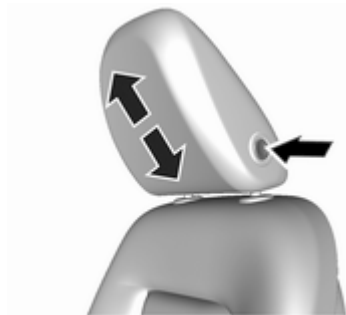

Press release button, adjust height, engage.

Head restraints ⇨ 37.

Seat belt



Pull out the seat belt and fasten in belt buckle. The seat belt must not be twisted and must fit close against the body. The backrest must not be tilted back too far (maximum approx. 25°).

To unfasten belt, press red button on belt buckle.

Seat position ⇨ 38.

Seat belts ⇨ 42.

Airbag system ⇨ 45.

Mirror adjustment

Interior mirror





To adjust the mirror, move the mirror housing in the desired direction.

Automatic anti-dazzle interior mirror ⇨ 33.

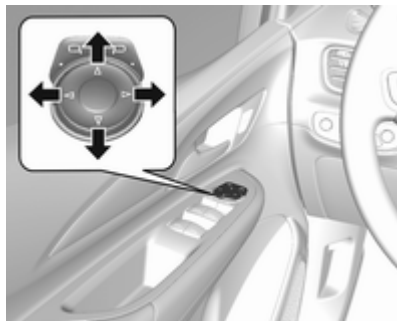
Exterior mirrors



Press  or  to select the relevant exterior mirror. Then press the control pad to adjust the respective mirror.

Convex exterior mirrors ⇨ 32.

Electric adjustment ⇨ 32.

Folding exterior mirrors ⇨ 32.

Heated exterior mirrors ⇨ 33.

Steering wheel adjustment



Unlock the lever, adjust the steering wheel, then engage the lever and ensure it is fully locked.

Do not adjust the steering wheel unless the vehicle is stationary and the steering wheel lock has been released.

Airbag system ⇨ 45.

Power button ⇨ 148.

Instrument panel overview

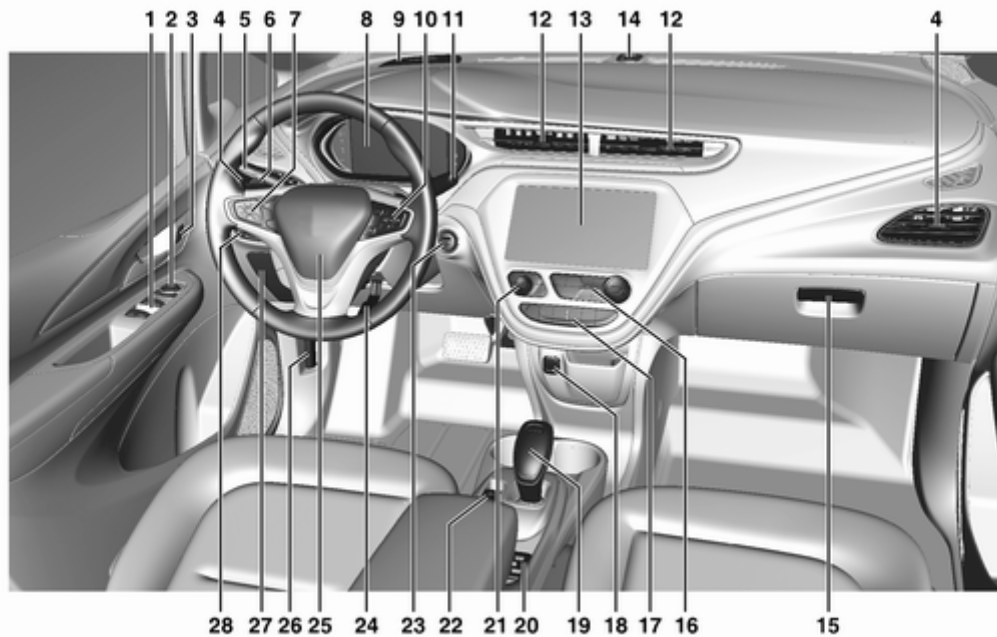

1	Power windows	34	12	Centre air vents	145	26	Bonnet release lever	212
2	Exterior mirrors	32	13	Info Display	85	27	Fuse box	227
3	Central locking system	20	14	Anti-theft alarm system status LED	30	28	Light switch	98
4	Side air vents	145		Light sensor	99		Headlight range adjustment	101
5	Turn lights, headlight flash, low / high beam, high beam assist	102		Charging status indicator	203		Rear fog lights	102
	Exit lighting	104	15	Glovebox	57		Instrument illumination	103
	Parking lights	102	16	Climate control system	141			
6	Regeneration on Demand ..	160	17	Hazard warning flashers	101			
7	Cruise control	163		Sport mode	153			
	Speed limiter	164		Traction Control system	161			
	Forward collision alert	166		Electronic Stability Control .	162			
	Heated steering wheel	65		Parking assist / Advanced parking assist	173			
8	Instruments	74		Lane keep assist	190			
	Driver Information Centre	82	18	Power outlet	69			
9	Forward collision alert indicator	166	19	Selector lever	153			
	Front pedestrian alert	171	20	USB port				
10	Buttons for Driver Information Centre	82	21	Controls for Info Display operation	85			
11	Windscreen wiper and washer, rear wiper and washer	66	22	Parking brake	158			
			23	Power button	148			
			24	Steering wheel adjustment ..	65			
			25	Horn	66			

Exterior lighting



AUTO : automatic light control switches automatically between daytime running light and headlight

- ☞☞ : sidelights
- ☞D : headlights
- ⏻ : activation or deactivation of the automatic light control.

Automatic light control ⇨ 99.

Rear fog lights

Press button ☞# to activate the rear fog lights.

Headlight flash, high beam and low beam



- pull stalk : headlight flash
- push stalk : high beam

High beam ⇨ 99.

Headlight flash ⇨ 101.

High beam assist ⇨ 100.

Turn lights

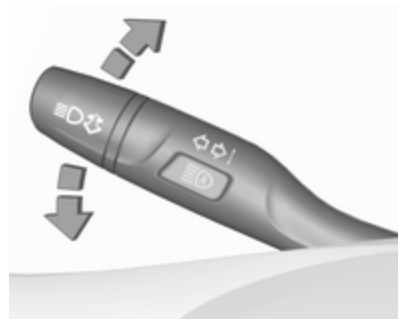



- stalk up : right turn light
- stalk down : left turn light

Turn lights ⇨ 102.

Parking lights ⇨ 102.

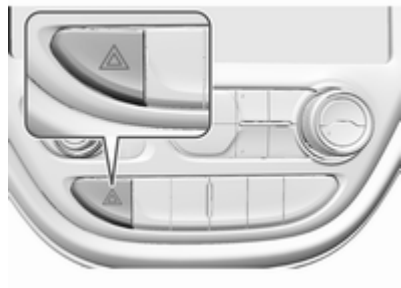
Hazard warning flashers



Operated by pressing .
Hazard warning flashers ⇨ 101.

Horn

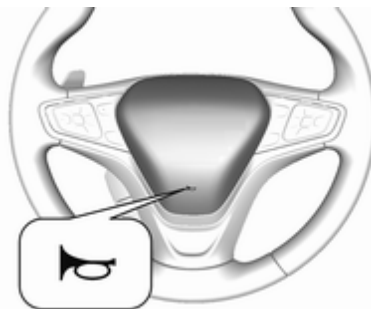

Press .

Pedestrian safety alert

Pedestrian safety signal enables the driver to alert people who may not hear the vehicle approaching.

The automatic sound is generated to indicate the vehicle presence to pedestrians. The sound changes if the vehicle is speeding up or slowing down. It is activated when the vehicle is shifted into a forward gear or **R**, up to 23 km/h.

Pedestrian safety alert ⇨ 66.

Washer and wiper systems

Windscreen wiper



- HI** : fast
LO : slow
AUTO : automatic wiping with rain sensor
OFF : off

For single wipe when the wiper is off, press lever down to position **1x**.

Windscreen wiper ⇨ 66.

Windscreen washer

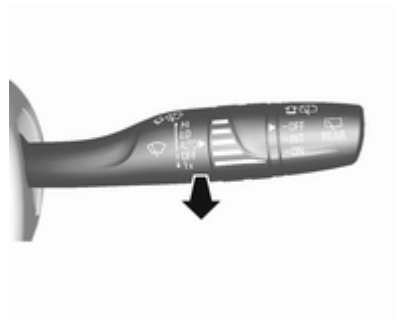

Pull lever.

Windscreen washer system ⇨ 66.

Washer fluid ⇨ 215.

Wiper blade replacement ⇨ 218.

Rear window wiper



Turn outer cap to activate the rear window wiper:

- OFF** : off
INT : intermittent operation
ON : continuous operation

Rear window washer



Push lever.

Washer fluid is sprayed on the rear window and the wiper wipes a few times.

Rear window wiper and washer
⇨ 68.

Climate control

Heated rear window

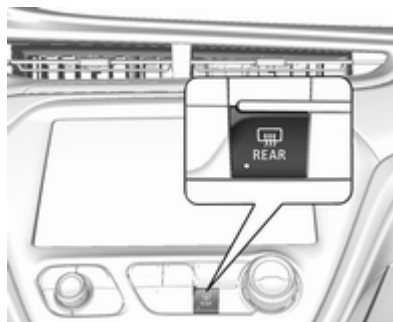

The heating is operated by pressing .

Heated rear window ⇨ 35.

Heated exterior mirrors

Pressing  also activates the heated exterior mirrors.

Heated exterior mirrors ⇨ 33.

Demisting and defrosting the windows



Press .

Temperature and air distribution are set automatically and the fan runs at high speed.

Switch on heated rear window .

Electronic climate control system
⇨ 141.

Electric drive unit



P : Park
R : Reverse
N : Neutral
D : Drive
L : Low

The selector lever can only be moved out of **P** when the vehicle is on, the brake pedal is depressed, and then the release button is pressed.



Electric drive unit ⇨ 153.

Starting off

Check before starting off

- Tyre pressure ⇨ 231 and condition ⇨ 253.
- Fluid levels ⇨ 213.
- All windows, mirrors, exterior lighting and number plates are free from dirt, snow and ice and are operational.
- Proper position of mirrors ⇨ 32, seats ⇨ 38, and seat belts ⇨ 43.
- Brake function at low speed, particularly if the brakes are wet.

Starting the vehicle

- Depress brake pedal and press **POWER** . When the vehicle ready light  illuminates in the instrument cluster, the vehicle is ready to be driven.
- Move the steering wheel slightly to release the steering wheel lock.
- Do not operate accelerator pedal.



Starting and stopping the vehicle
⇨ 150.

Parking

Note

Do not allow the vehicle to remain in extreme temperatures for long periods without being driven or being plugged in.

Warning

- Always apply parking brake. Pull switch  for approx. 1 second and check if the control indicator  illuminates. The electric parking brake is applied when control indicator  illuminates ⇨ 79.
- Switch off the vehicle.
- If the vehicle is on a level surface or uphill slope, apply the parking brake and set the selector lever to **P** before switching off the vehicle. On an uphill slope, turn the front wheels away from the kerb. If the vehicle is on a downhill slope, apply the parking brake and set the selector lever to **P**

before switching off the vehicle. Turn the front wheels towards the kerb.

With the selector lever in **P**, press **POWER**  briefly to switch off the vehicle. Turn the steering wheel until the steering wheel lock engages.

- Lock the vehicle with  on the electronic key. Activate the anti-theft alarm system ⇨ 30.
- The cooling fans may run after the vehicle has been switched off ⇨ 211.

Keys, locks ⇨ 16.

Laying-up the vehicle for a long period of time ⇨ 210.

Keys, doors and windows

Keys, locks	16
Keys	16
Radio remote control	17
Electronic key system	19
Memorised settings	20
Central locking system	20
Delayed locking	25
Automatic locking	25
Child locks	26
Smartphone remote function	27
Doors	29
Load compartment	29
Vehicle security	29
Anti-theft locking system	29
Anti-theft alarm system	30
Immobiliser	31
Exterior mirrors	32
Convex shape	32
Electric adjustment	32
Folding mirrors	32
Heated mirrors	33
Interior mirrors	33
Automatic anti-dazzle	33

Windows	33
Windscreen	33
Power windows	34
Heated rear window	35
Sun visors	36

Keys, locks

Keys

Replacement keys

The key number is specified on a detachable tag.

The key number must be quoted when ordering replacement keys as it is a component of the immobiliser system.

Locks ⇨ 243.

Central locking ⇨ 20.

Starting and stopping the vehicle
⇨ 150.

Radio remote control ⇨ 17.

Electronic key ⇨ 19.

The code number of the adapter for the locking wheel nuts is specified on a card. It must be quoted when ordering a replacement adapter.

Radio remote control



Enables operation of the following functions via the use of the remote control buttons on the electronic key:

- central locking system ⇨ 20
- anti-theft locking system ⇨ 29
- anti-theft alarm system ⇨ 30
- remote start

The remote control has a range of up to 60 m, but may also be much less due to external influences. The hazard warning flashers confirm operation.

Handle with care, protect from moisture and high temperatures and avoid unnecessary operation.

Remote start

Activates the heating or air conditioning systems and the heated rear window from outside the vehicle.

The climate control system will typically default to the last climate setting. If the fan is off or if fan only was selected, the air conditioning or heat will turn on as needed.

Electronic climate control system
⇨ 141.

If the vehicle has heated seats and the vehicle personalisation setting enabled, the remote start auto heated seats may also come on.



Heated front seats ⇨ 41.

Vehicle personalisation ⇨ 90.

If the vehicle is low on electricity, do not use the remote start feature. The vehicle may run out of electricity.

The remote control range may be reduced while the vehicle is running.

Activating

1. Press and release .
2. Immediately press and hold  until the turn lights flash or for at least 4 seconds. Pressing and holding  again during remote start will turn the feature off.

Remote start will automatically shut off after 20 minutes, unless a time extension is activated.

After entering the vehicle during remote start, press **POWER**  on the instrument panel with the brake pedal depressed to operate as normal.

Extending the time

To extend the time by another 20 minutes, repeat the steps for activating remote start. Remote start can only be extended once.

labelling Cancellng remote start

To cancel remote start, do any of the following:

- Aim the radio remote control at the vehicle and press and hold **Q** until the sidelights turn off.
- Turn on the hazard warning flashers.
- Press **POWER** ϕ on the instrument panel with the brake pedal depressed, then press **POWER** ϕ again to switch off the vehicle.

labelling Conditions in which remote start will not work

- An open bonnet.
- Vehicle propulsion system fault conditions.
- High voltage battery fault conditions.
- The selector lever is not in **P** (Park).

Conditions in which remote start may be cancelled include:

- Vehicle propulsion system or high voltage battery fault conditions.
- Electric drive unit coolant temperature is too high.

labelling Replacing battery in the electronic key

Replace the battery as soon as the range reduces.



Batteries do not belong in household waste. They must be disposed of at an appropriate recycling collection point.



1. Press button at the back of the electronic key unit and extract the key blade from the housing.



2. Insert the key blade for approx. 6 mm and turn the key to open the housing. Further insertion of the key blade can damage the housing.
3. Remove and replace battery. Use CR 2032 or equivalent battery. Pay attention to the installation position.
4. Close the housing and insert key blade.

Radio remote control synchronisation

After replacing the battery, unlock the door with the key in the driver's door lock. The radio remote control will be synchronised when you switch on the vehicle.

Fault

If the central locking system cannot be operated with the radio remote control, the cause may be one of the following:

- Fault in radio remote control.
- The range is exceeded.
- The battery voltage is too low.

- Frequent, repeated operation of the radio remote control while not in range, which will require re-synchronisation.
- Overload of the central locking system by operating at frequent intervals, the power supply is interrupted for a short time.
- Interference from higher-power radio waves from other sources.

Manual unlocking ⇨ 20.

Electronic key system

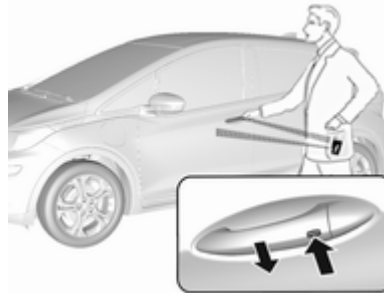

Enables a keyless operation of the following functions:

- central locking system ⇨ 20
- tailgate ⇨ 29
- starting and stopping the vehicle ⇨ 150

The electronic key simply needs to be on the driver's person.

Additionally, the electronic key includes the functionality of the radio remote control ⇨ 17.

Handle with care, protect from moisture and high temperatures and avoid unnecessary operation.

Note

Do not put the electronic key into the load compartment or in front of the Info Display.

Replacing battery in electronic key

Replace the battery as soon as the system no longer operates properly or the range is reduced. The need for battery replacement is indicated by a message in the Driver Information Centre ⇨ 89.

Battery replacement in the electronic key ⇨ 17.

Electronic key synchronisation

The electronic key synchronises itself automatically during every starting procedure.

Fault

If the central locking cannot be operated or the propulsion system cannot be started, the cause may be one of the following:

- Fault in electronic key.
- Electronic key is out of reception range.
- The battery voltage is too low.
- Overload of the central locking system by operating at frequent intervals, the power supply is interrupted for a short time.
- Interference from higher-power radio waves from other sources.

To rectify the cause of the fault, change the position of the electronic key.

Manual unlocking ⇨ 20.

Memorised settings

Whenever the ignition is switched off, some functions of the following settings may be automatically memorised by the remote control unit or the electronic key:

- automatic climate control
- lighting
- Infotainment system
- central locking system
- comfort settings

The saved settings are automatically used the next time the vehicle is switched on with the memorised electronic key ⇨ 19.

A precondition is that **Personalisation by driver** is activated in the personal settings of the Info Display. This must be set for each electronic key which is used. The status change is available only after locking and unlocking the vehicle.

Vehicle personalisation ⇨ 90.

Central locking system

Unlocks and locks doors and load compartment.

A pull on an interior door handle unlocks the respective door. Pulling the handle once more opens the door.

Note

In the event of an accident in which airbags or belt pretensioners are deployed, the vehicle is automatically unlocked.

Note

A short time after unlocking with the remote control the doors are locked automatically if no door has been opened. A precondition is that the setting is activated in the vehicle personalisation ⇨ 90.



Remote control operation

Unlocking



Press .

Unlocking mode can be set in the vehicle personalisation menu in the Info Display. Two settings are selectable:

- All doors and load compartment will be unlocked by pressing  once.
- Only the driver's door and load compartment will be unlocked by pressing  once. To unlock all doors, press  twice.

Select the relevant setting in **Settings** → **Vehicle settings** in the Info Display.

Info Display ⇨ 85.

Vehicle personalisation ⇨ 90.

The setting can be saved for the remote control being used.

Memorised settings ⇨ 20.

Unlocking and opening the tailgate ⇨ 29.

Locking

Close doors and load compartment.



Press .

If the driver's door is ajar, the central locking system will not work.

Confirmation

Operation of the central locking system is confirmed by the hazard warning flashers. A precondition is that the setting is activated in the vehicle personalisation ⇨ 90.

Electronic key system operation

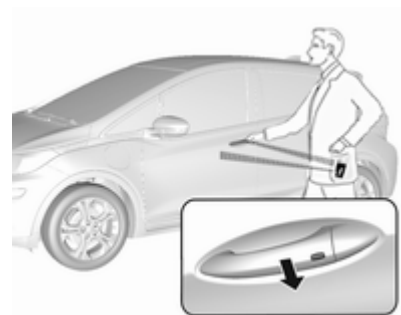

The electronic key must be outside the vehicle, within a range of approx. 1 m of the relevant door side.

Unlocking



Press the button on the respective exterior door handle and pull the handle.

Unlocking mode can be set in the vehicle personalisation menu in the Info Display. Two settings are selectable:

- All doors and load compartment will be unlocked by pressing the button on any exterior handle once.
- Only the driver's door and load compartment will be unlocked by pressing the button on the



driver's door exterior handle once. To unlock all doors, press button twice.

The setting can be changed in the menu **Settings** in the Info Display.

Vehicle personalisation ↻ 90.

Disabling keyless unlocking

Keyless unlocking of the doors and load compartment can be disabled when the vehicle is switched off.

To disable keyless unlocking, press and hold  and  at the same time for approx. 3 seconds.



After disabling keyless unlocking, the turn lights flash four times briefly. The turn lights will flash four times again when trying to open any door or the tailgate to indicate that keyless unlocking is disabled.

Note

When keyless unlocking is disabled, the anti-theft alarm system has to be disarmed before starting the vehicle.

Enabling keyless unlocking

Keyless unlocking of the doors and load compartment can be enabled when the vehicle is switched off.

To enable keyless unlocking, press and hold  and  at the same time for approx. 3 seconds.

After enabling keyless unlocking, the turn lights flash twice briefly.

Locking



Press the button on any exterior door handle.

All doors and load compartment will be locked.

The system locks if any of the following occurs:

- It has been more than 5 seconds since unlocking.
- The button on an exterior handle has been pressed twice within 5 seconds to unlock the vehicle.
- Any door has been opened and all doors are now closed.

If the driver's door is ajar or the electronic key remains in the vehicle, locking will not be permitted.

If there have been two or more electronic keys in the vehicle and the vehicle was on once, the doors will be locked even if just one electronic key is taken out of the vehicle.

Unlocking and opening the tailgate

The tailgate can be unlocked and opened by pushing the touchpad switch when the electronic key is in range. The doors remain locked.

Load compartment ⇨ 29.



Operation with buttons on the electronic key





The central locking system can also be operated with the buttons on the electronic key.

Press  to unlock.

Press  to lock.

Press and release  and then immediately press and hold  for at least 4 seconds to start the vehicle's heating or air conditioning systems and the heated rear window from outside the vehicle.

Press  to stop charging the vehicle. Press and hold  until the lock of the charge cable is released.

Remote start ⇨ 20.

Remote control operation ⇨ 20.

Passive locking

Automatic locking ⇨ 25.

Confirmation

Operation of central locking system is confirmed by the hazard warning flashers. A precondition is that the setting is activated in the vehicle personalisation ⇨ 90.

Central locking buttons

Locks or unlocks all doors and load compartment via a switch in the driver's door panel.



Press  to lock.

Press  to unlock.

Operation with the key in case of a central locking system fault

In case of a fault, e.g. vehicle battery or electronic key battery is discharged, the driver's door can be locked or unlocked with the mechanical key.

The lock cylinder in the driver's door is covered by a cap.

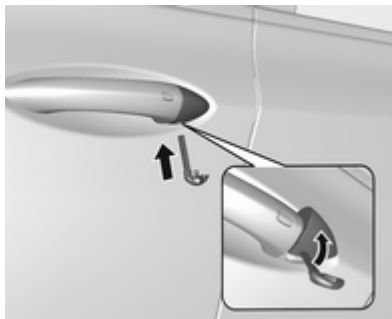

To remove the cap, press button at the back and extract the key blade from the housing. Insert the key into the recess at the bottom of the cap and swivel the key upward.

Electronic key system ⇨ 19.

Manual unlocking



Manually unlock the driver's door by inserting and turning the key in the lock cylinder.

The other doors can be opened by pulling the interior handle twice or by pressing  in the driver's door panel. The load compartment will possibly not be unlocked.

By switching on the vehicle, the anti-theft locking system is deactivated.

Manual locking



Push inside locking knob of all doors except driver's door or press  in the driver's door panel. Then close the driver's door and lock it from the outside by turning the key in the lock cylinder. The load compartment is possibly not locked.

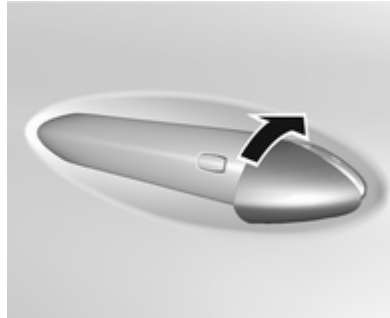

After locking, cover the lock cylinder with the cap: insert the cap with the lower side in the recesses, swivel and push the cap until it engages at the upper side.

Delayed locking



This feature delays the actual locking of the doors and activating of the anti-theft alarm system for 5 seconds when the button on the door handle or electronic key is used to lock the vehicle.



Delayed locking can only be turned on when the **Unlocked door anti lockout** feature has been turned off.

This can be changed in the vehicle settings.

Vehicle personalisation ⇨ 90.

On: When pressing the central locking button , three chimes will sound to signal delayed locking is activated.

The doors will not lock until 5 seconds after the last door is closed. Delayed locking can be temporarily overridden by pressing the central locking button  or  on the electronic key.

Off: The doors will lock immediately when pressing the central locking button  or  on the electronic key.

Automatic locking

Automatic locking after driving off

This security feature can be configured to automatically lock all doors and load compartment after the selector lever is moved out of **P**.

When at a standstill after driving, the vehicle will be unlocked automatically as soon as the vehicle is switched off.

Activation or deactivation of automatic locking can be set in the menu **Settings ▶ Vehicle settings** in the Info Display.

Info Display ⇨ 85.

Vehicle personalisation ⇨ 90.

The setting can be saved for the electronic key being used ⇨ 20.

Automatic relock after unlocking

This feature can be configured to automatically lock all doors and load compartment a short time after unlocking with the electronic key, provided no door has been opened.

Activation or deactivation of automatic relock can be set in the menu **Settings ▶ Vehicle settings** in the Info Display.

Info Display ⇨ 85.

Vehicle personalisation ⇨ 90.

The setting can be saved for the electronic key being used ⇨ 20.

Passive door lock

This feature locks the vehicle automatically after several seconds if an electronic key has been recognised previously inside the vehicle, all doors have then been closed and the electronic key does not remain within the vehicle.

If the electronic key remains in the vehicle or the vehicle is not off, passive door lock will not be permitted.

If there have been two or more electronic keys in the vehicle and the vehicle was on once, the feature locks the vehicle if just one electronic key is taken out of the vehicle.

To prevent locking of the vehicle e.g. when passengers remain in the vehicle, the system must be disabled.

To disable the system, press the central locking button for a few seconds while one door is open. The function remains disabled until the central locking button is pressed or the vehicle is switched on.

Activation or deactivation of passive locking can be set in the menu **Settings ▶ Vehicle settings ▶ Remote lock / unlock / start** in the Info Display.

Info Display ⇨ 85.

Vehicle personalisation ⇨ 90.

The setting can be saved for the electronic key being used ⇨ 20.

Child locks

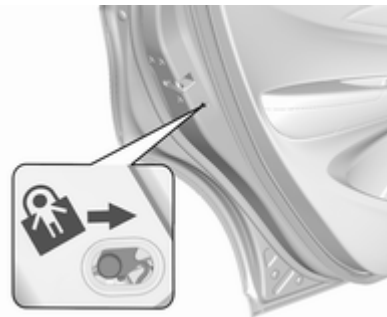

⚠ Warning

Use the child locks whenever children are occupying the rear seats.

Move the pin in the rear door to the front position. The door cannot be opened from the inside.

To deactivate, move the pin to the rear position.

Smartphone remote function

This feature allows a smartphone to be connected to the vehicle and remote vehicle functions to be requested. Features vary depending on availability.

Features include:

- Remote commands: Use to lock / unlock the vehicle, remote start for the cabin climate, or sound or cancel the horn and flash the lights.

- Vehicle status: View the vehicle's range and high voltage battery level, charging status, and tyre pressure.
- Welcome lighting: Request light when approaching the vehicle.
- Location services: Save the parked location or start navigation at the vehicle's GPS coordinates.

Setup function

- **KeyPass** setup
 - Managing priority setting
 - Modifying priority setting
- Revocation

Active remote function

- Door lock / unlock
- Start / stop
- Charge termination
- High voltage battery charge functions
 - Temporary charging override update
 - Change the charging mode permanently

- Update departure time schedule
- High voltage battery priority charging activation and deactivation
- Select charge level / limit preference screen
- Vehicle locator
- Vehicle range

Passive function

Approach detection / welcome lighting

Visual display for vehicle information

- Low high voltage battery indication
- Tyre pressure
- Odometer reading
- Tailgate ajar status
- Electric parking brake status
- Bonnet status
- High voltage battery state of charge status

- Vehicle's position
- Charge mode status
 - Vehicle range
 - Charge start and end times status
 - Full week of time based delayed charging status
 - Disable rate based and delayed charging status
 - High voltage charging system fault (unable to charge)
 - High voltage charger power level
 - High voltage battery charge cord connected indication
 - Charge complete
 - Usable state of charge
 - High voltage depletion mode range
 - High voltage battery state of charge status

Pairing

A smartphone must be paired to the KeyPass module and then it must be connected to the vehicle before it can be used.

Setup information

- Up to three smartphones can be set up and connected to the vehicle.
- Setup is disabled when the vehicle is moving.
- Pairing only needs to be completed once per smartphone, unless the pairing information on the smartphone changes or the smartphone is deleted.

Setup process

1. The vehicle must be switched on and the selector lever in **P** (Park).
2. Enable the KeyPass function through vehicle personalisation.
3. Download the myOpel app to the smartphone from the appropriate app store.

4. Open the app and search for new vehicles.
5. Choose your vehicle and confirm.
6. Aim the smartphone camera at the QR code on the Info Display to scan the security key. If the camera is not working, the QR code can be entered manually.
7. The Info Display provides confirmation that the pairing process was completed successfully.
 - Select **Settings** on the **Home** screen on the Info Display.
 - Select **KeyPass**.
 - Select **Manage KeyPass devices**.

Deleting a paired smartphone

1. Select **Settings** on the **Home** screen on the Info Display.
2. Select **KeyPass**.
3. Select **Manage KeyPass devices**.
4. Touch **Delete** next to the smartphone to be deleted, and follow the prompts.

Doors

Load compartment

Tailgate

Opening



After unlocking, push the touchpad switch and open the tailgate.

Closing

Use the interior handles.

Do not push the touchpad switch whilst closing as this will unlock the tailgate again.

Central locking system ⇨ 20.

General hints for operating tailgate

Caution

Before opening the tailgate, check overhead obstructions, e.g. a garage door, to avoid damage to the tailgate. Always check the moving area above and behind the tailgate.

Note

The installation of certain heavy accessories onto the tailgate may affect its ability to remain open.

Vehicle security

Anti-theft locking system

⚠ Warning

Do not use the system if there are people in the vehicle! The doors cannot be unlocked from the inside.

The system deadlocks all the doors. All doors must be closed otherwise the system cannot be activated.

Unlocking the vehicle disables the mechanical anti-theft locking system. This is not possible with the central locking button.

Activating



Press  on the electronic key twice within 5 seconds.

Anti-theft alarm system

The anti-theft alarm system is combined with the anti-theft locking system.



It monitors the doors, tailgate, bonnet and if the vehicle is being switched on.

Activation

All doors must be closed and the electronic key of the electronic key system must not remain in the vehicle. Otherwise the system cannot be activated.

- Radio remote control: self-activated 30 seconds after locking the vehicle by pressing  once.
- Electronic key system: self-activated 30 seconds after locking the vehicle by pressing the button on any exterior door handle.



- Radio remote control or electronic key: directly by pressing  twice within 5 seconds.
- Electronic key system with passive locking enabled: briefly activated after passive locking occurs.
- Central locking button: with a door open, press .

Deactivation

Radio remote control: Unlocking the vehicle by pressing  deactivates the anti-theft alarm system.



Electronic key system: Unlocking the vehicle by pressing the button on any exterior door handle deactivates the anti-theft alarm system.

The electronic key must be outside the vehicle, within a range of approx. 1 m of the relevant door side.

The system is not deactivated by unlocking the driver's door with the key or with the central locking button in the passenger compartment.

Alarm

When triggered, the alarm horn sounds and the hazard warning lights flash simultaneously. The number and duration of alarm signals are stipulated by legislation.

The anti-theft alarm system can be deactivated by pressing , by pressing the button on the door handle or switching on the vehicle.

A triggered alarm, which has not been interrupted by the driver, will be indicated by the hazard warning lights. They will flash quickly three times the next time the vehicle is unlocked with the radio remote control. Additionally, a warning

message is displayed in the Driver Information Centre after switching on the vehicle.

Vehicle messages ⇨ 89.

Immobiliser

The system is part of the ignition switch and checks whether the vehicle is allowed to be started with the key being used.

The immobiliser is activated automatically after the electronic key has been removed from the vehicle.

If control indicator  flashes when the vehicle is on, there is a fault in the system. The propulsion system cannot be started. Switch off the vehicle and repeat the start attempt.

If control indicator  continues flashing, attempt to start the propulsion system using the spare key and seek the assistance of a workshop.

Note

Radio Frequency Identification (RFID) tags may cause interference with the key. Do not have it placed near the key when starting the vehicle.

Note

The immobiliser does not lock the doors. You should always lock the vehicle after leaving it and switch on the anti-theft alarm system ⇨ 20, ⇨ 30.

Control indicator  ⇨ 81.

Exterior mirrors





Convex shape

The shape of the mirror makes objects appear smaller, which will affect the ability to estimate distances.

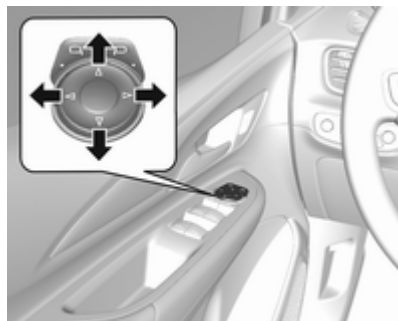
Side blind zone assistant ↗ 180.

Electric adjustment



1. Press  or  to select the relevant exterior mirror. Then press the control pad to adjust the respective mirror.
2. Press  or  again to deselect the mirror.



Folding mirrors



For pedestrian safety, the exterior mirrors will swing out of their normal mounting position if they are struck with sufficient force. Reposition the mirror by applying slight pressure to the mirror housing.

Electric folding



Press  to fold both exterior mirrors. Press  again - both exterior mirrors to return to their original position. If an electrically folded mirror is manually extended, pressing  will only electrically extend the other mirror.

Heated mirrors

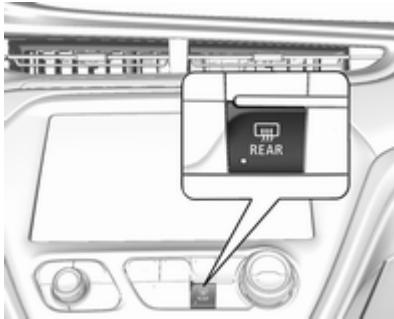

Operated by pressing .

The LED in the button indicates activation.

Heating works after the vehicle has been started and is switched off automatically after a short time.

Interior mirrors

Automatic anti-dazzle

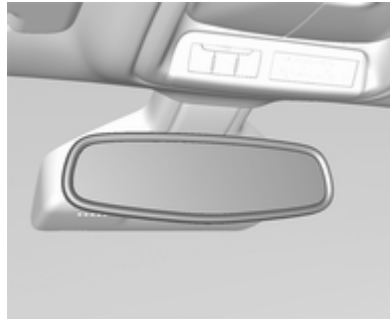

Dazzle from following vehicles is automatically reduced, when driving in the dark.

Windows

Windscreen

Windscreen stickers

Do not attach stickers such as toll road stickers or similar on the windscreen in the area of the interior mirror. Otherwise the detection zone of the sensor and the view area of the camera in the windshield array near the interior mirror could be restricted.

Windscreen replacement

Caution

If the vehicle has a front-looking camera sensor for the driver assistance systems, it is very important that any windscreen replacement is performed accurately according to Opel specifications. Otherwise, these systems may not work properly and there is a risk of unexpected behaviour and / or messages from these systems.

Power windows

⚠ Warning

Take care when operating the power windows. Risk of injury, particularly to children.

If there are children on the rear seats, switch on the child safety system for the power windows.

Keep a close watch on the windows when closing them. Ensure that nothing becomes trapped in them as they move.

Switch on the vehicle to operate power windows.

Retained power off ⇨ 150.



Operate the switch for the respective window by pushing to open or pulling to close.

All windows: Pushing or pulling the switch gently to the first detent moves the window down or up as long as the switch is operated.

The driver's window opens or closes automatically with safety function enabled when the switch  is pushed or pulled firmly to the second detent. To stop movement, operate the switch once more in the same direction. The co-driver's window opens automatically when respective switch is being pushed firmly to the second detent.

Safety function

If the driver's window glass encounters resistance above the middle of the window during automatic closing, it is immediately stopped and opened again.

Override safety function

In the event of closing difficulties due to frost or the like, switch on the vehicle, then pull the switch to the first detent and hold. The window moves up without safety function enabled. To stop movement, release the switch.

Child safety system for rear windows



To deactivate rear door power windows, press . The LED illuminates.

To activate, press  again.

Overload

If the windows are repeatedly operated within short intervals, the window operation is disabled for some time.

Initialising the power windows

If the driver's window cannot be closed automatically (e.g. after disconnecting the vehicle battery), a warning message is displayed in the Driver Information Centre.

Vehicle messages ⇨ 89.

Activate the window electronics as follows:

1. Close doors.
2. Switch on the vehicle.
3. Push switch until the window is completely open and keep pushing for additional 2 seconds.
4. Pull switch until the window is closed and keep pulling for additional 2 seconds.
5. Repeat for each window.

Heated rear window

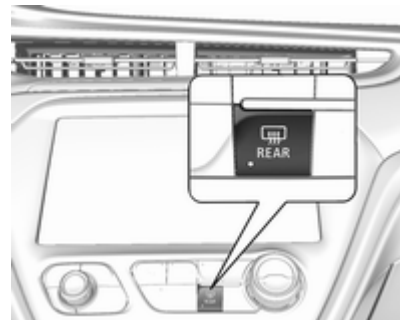

Operated by pressing .

The LED in the button indicates activation.

Heating works after the vehicle has been started and is switched off automatically after a short time.

Sun visors

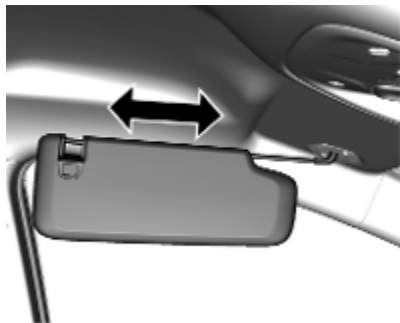

The extendable sun visors can be folded down or swivelled to the side to prevent dazzling.

The covers of the mirrors should be closed when driving.

A ticket holder is located on the backside of the sun visor.

Seats, restraints

Head restraints	37
Front seats	38
Seat position	38
Manual seat adjustment	39
Armrest	40
Heating	41
Rear seats	42
Armrest	42
Heating	42
Seat belts	42
Three-point seat belt	43
Airbag system	45
Front airbag system	48
Side airbag system	48
Curtain airbag system	49
Airbag deactivation	49
Child restraints	51
Child restraint systems	51
Child restraint installation locations	53

Head restraints

Position

⚠ Warning

Only drive with the head restraint set to the proper position.

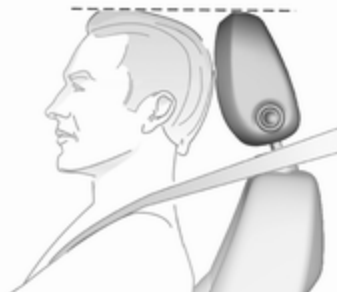

The upper edge of the head restraint should be at upper head level. If this is not possible for extremely tall people, set to highest position, and set to lowest position for small people.

Adjustment

Head restraints on front seats



Height adjustment

Press release button, adjust height, engage.

Head restraints on rear seats

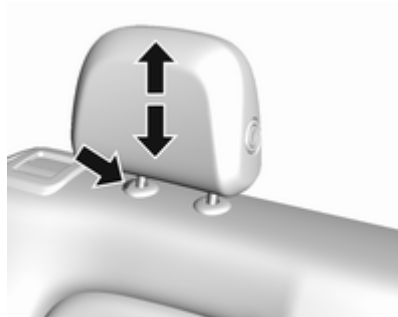

Height adjustment

Pull the head restraint upwards or press the catch to release and push the head restraint downwards.

Removal of rear head restraints

E.g. for load compartment extension
↪ 59.

Before removing a rear head restraint, release the respective rear seat and fold slightly forwards to ensure there is enough space for removal.

Press both catches, pull the head restraint upwards and remove.

Folding

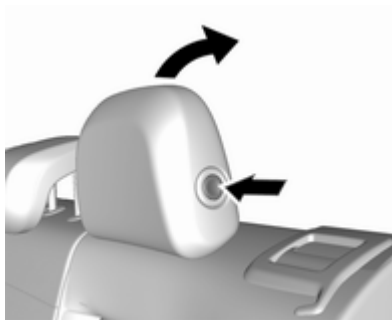

Fold the head restraint for better visibility only when the rear seat is unoccupied. Press the button and push the head restraint rearward.

To return to its upright position, pull the head restraint forward until it locks in place.

⚠ Warning

The head restraint must be in upright position when the rear seat is occupied.

Front seats

Seat position

⚠ Warning

Only drive with the seat correctly adjusted.

⚠ Danger

Do not sit closer than 25 cm to the steering wheel, to permit safe airbag deployment.

⚠ Warning

Never adjust seats while driving as they could move uncontrollably.

⚠ Warning

Never store any objects under the seats.



- Sit with buttocks as far back against the backrest as possible. Adjust the distance between the seat and the pedals so that legs are slightly angled when fully pressing the pedals. Slide the front passenger seat as far back as possible.
- Set seat height high enough to have a clear field of vision on all sides and of all display instruments. There should be at least one hand of clearance between head and the roof frame. Your thighs should rest lightly on the seat without pressing into it.

- Sit with shoulders as far back against the backrest as possible. Set the backrest rake so that it is possible to easily reach the steering wheel with arms slightly bent. Maintain contact between shoulders and the backrest when turning the steering wheel. Do not angle the backrest too far back. We recommend a maximum rake of approx. 25°.
- Adjust seat and steering wheel in a way that the wrist rests on top of the steering wheel while the arm is fully extended and shoulders on the backrest.
- Adjust the steering wheel ↻ 65.
- Adjust the head restraint ↻ 37.

Manual seat adjustment

Drive only with engaged seats and backrests.

Longitudinal adjustment



Pull handle, slide seat, release handle. Try to move the seat back and forth to ensure that the seat is locked in place.

Backrest inclination

Pull lever, adjust inclination and release lever. Allow the backrest to engage audibly.

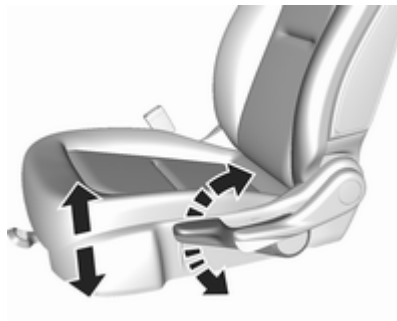
Seat height

Lever pumping motion
up : seat higher
down : seat lower

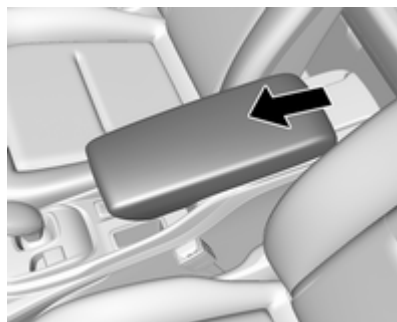
Armrest

The armrest can be slid forwards by 9 cm. Under the armrest there is a storage compartment.

Armrest storage ⇨ 58.

Heating



Adjust heating to the desired setting by touching  for the respective seat one or more times. The control indicator in the button indicates the setting.

Prolonged use of the highest setting for people with sensitive skin is not recommended.

Auto heated seats

When the vehicle is on, this feature will automatically activate seat heating at the level required by the vehicle's interior temperature.

The indicators next to the seat heating symbol on the touch screen indicate the heat setting.

Use the touch screen button to turn auto heated seats off.

The auto heated seat feature can be programmed to always be enabled when the vehicle is on.

Vehicle personalisation ⇨ 90.

Deactivation

To deactivate auto heated seat, touch  **AUTO** on the touch screen.

Remote start heated seats

When it is cold outside, the heated seats can be turned on automatically during a remote vehicle start.

The heated seats will be cancelled when **POWER**  is pressed. If the vehicle has auto heated seats, the seat heating level will automatically change to the level required by the vehicle's interior temperature when the vehicle is turned on.

The temperature performance of an unoccupied seat may be reduced.

The heated seats will not switch on during a remote start unless the heated seat feature is enabled in vehicle personalisation ⇨ 90.

Rear seats

Armrest

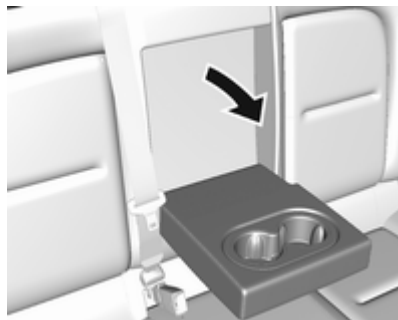

Fold armrest down. The armrest contains cupholders.

Heating



Activate seat heating by pressing  in the door panel for the respective rear outer seat. Activation is indicated by the LED in the button.

Press  once more to deactivate seat heating.

Prolonged use for people with sensitive skin is not recommended.

Seat heating is operational when engine is running.

Seat belts



The seat belts are locked during heavy acceleration or deceleration of the vehicle, holding the occupants in the seat position. Thereby the risk of injury is considerably reduced.

Warning

Fasten seat belt before each trip.

In the event of an accident, people not wearing seat belts endanger their fellow occupants and themselves.

Seat belts are designed to be used by only one person at a time.

Child restraint system ⇨ 51.



Periodically check all parts of the belt system for damage, soiling and proper functionality.

Have damaged components replaced by a workshop. After an accident, have the belts and triggered belt pretensioners replaced by a workshop.

Note

Make sure that the belts are not damaged by shoes or sharp-edged objects or trapped. Prevent dirt from getting into the belt retractors.

Seat belt reminder

Each front seat is equipped with a seat belt reminder, indicated for the driver seat by control indicators  in the Driver Information Centre ⇨ 77, or for passenger seat by the symbol  in the overhead console ⇨ 77.

Belt force limiters

Stress on the body is reduced by the gradual release of the belt during a collision.

Belt pretensioners

In the event of a head-on, rear-end or side-on collision of a certain severity, the front and rear seat belts are tightened. The front seat belts are tightened by two pretensioners per seat. The outer rear seat belts are tightened by one pretensioner per seat.

Warning

Incorrect handling (e.g. removal or fitting of belts) can trigger the belt pretensioners.

Deployment of the belt pretensioners is indicated by continuous illumination of control indicator  ⇨ 78.

Triggered belt pretensioners must be replaced by a workshop. Belt pretensioners can only be triggered once.

Note

Do not affix or install accessories or other objects that may interfere with the operation of the belt pretensioners. Do not make any modifications to belt pretensioner components as this will invalidate the operating permit of your vehicle.

Three-point seat belt

Fasten



Withdraw the belt from the retractor, guide it untwisted across the body and insert the latch plate into the

buckle. Tighten the lap belt regularly whilst driving by pulling the shoulder belt.

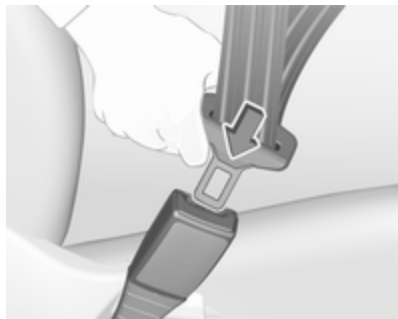

Loose or bulky clothing prevents the belt from fitting snugly. Do not place objects such as handbags or mobile phones between the belt and your body.

Warning

The belt must not rest against hard or fragile objects in the pockets of your clothing.

Seat belt reminder ,  77.

Unfasten



To release belt, press red button on belt buckle.

Using the seat belt while pregnant



Warning

The lap belt must be positioned as low as possible across the pelvis to prevent pressure on the abdomen.

Airbag system

The airbag system consists of a number of individual systems depending on the scope of equipment.

When triggered, the airbags inflate within milliseconds. They also deflate so quickly that it is often unnoticeable during the collision. When triggered the high voltage system of the vehicle is also deactivated.

⚠ Warning

The airbag system deploys in an explosive manner, repairs must be performed by skilled personnel only.

⚠ Warning

Adding accessories that change the vehicle's frame, bumper system, height, front end or side sheet metal, may keep the airbag system from working properly. The operation of the airbag system can

also be affected by changing any parts of the front seats, seat belts, airbag sensing and diagnostic module, steering wheel, instrument panel, inner door seals including the speakers, any of the airbag modules, ceiling or pillar trim, front sensors, side impact sensors or airbag wiring.



Note

The airbag sensing and diagnostic module is located in the centre console area. Do not put any magnetic objects in this area.

Do not affix any objects onto the airbag covers and do not cover them with other materials. Have damaged covers replaced by a workshop.

Each airbag is triggered only once. Have deployed airbags replaced by a workshop. Furthermore, it may be necessary to have the steering wheel, the instrument panel, parts of the panelling, the door seals, handles and the seats replaced.

Do not make any modifications to the airbag system as this will invalidate the vehicle operating permit.

Control indicator  for airbag systems  78.

Child restraint systems on front passenger seat with airbag systems

Warning according to ECE R94.02:



EN: NEVER use a rearward-facing child restraint on a seat protected by an ACTIVE AIRBAG in front of it; DEATH or SERIOUS INJURY to the CHILD can occur.

DE: Nach hinten gerichtete Kindersitze NIEMALS auf einem Sitz verwenden, der durch einen davor befindlichen AKTIVEN AIRBAG geschützt ist, da dies den TOD oder SCHWERE VERLETZUNGEN DES KINDES zur Folge haben kann.

FR: NE JAMAIS utiliser un siège d'enfant orienté vers l'arrière sur un siège protégé par un COUSSIN GONFLABLE ACTIF placé devant lui, sous peine d'infliger des BLESSURES GRAVES, voire MORTELLES à l'ENFANT.

ES: NUNCA utilice un sistema de retención infantil orientado hacia atrás en un asiento protegido por un AIRBAG FRONTAL ACTIVO. Peligro de MUERTE o LESIONES GRAVES para el NIÑO.

RU: ЗАПРЕЩАЕТСЯ устанавливать детское удерживающее устройство лицом назад на сиденье автомобиля, оборудованном фронтальной подушкой безопасности, если ПОДУШКА НЕ ОТКЛЮЧЕНА! Это

может привести к СМЕРТИ или СЕРЬЕЗНЫМ ТРАВМАМ РЕБЕНКА.

NL: Gebruik NOOIT een achterwaarts gericht kinderzitje op een stoel met een ACTIEVE AIRBAG ervoor, om DODELIJK of ERNSTIG LETSEL van het KIND te voorkomen.

DA: Brug ALDRIG en bagudvendt autostol på et forsæde med AKTIV AIRBAG, BARNET kan komme i LIVSFARE eller komme ALVORLIGT TIL SKADE.

SV: Använd ALDRIG en bakåtvänd barnstol på ett säte som skyddas med en framförvarande AKTIV AIRBAG. DÖDSFALL eller ALLVARLIGA SKADOR kan drabba BARNET.

FI: ÄLÄ KOSKAAN sijoita taaksepäin suunnattua lasten turvaistuinta istuimelle, jonka edessä on AKTIIVINEN TURVATYYNYY, LAPSI VOI KUOLLA tai VAMMAUTUA VAKAVASTI.

NO: Bakovervendt barnesikringsutstyr må ALDRI brukes på et sete med AKTIV KOLLISJONSPUTE foran, da det kan

føre til at BARNET utsettes for LIVSFARE og fare for ALVORLIGE SKADER.

PT: NUNCA use um sistema de retenção para crianças voltado para trás num banco protegido com um AIRBAG ACTIVO na frente do mesmo, poderá ocorrer a PERDA DE VIDA ou FERIMENTOS GRAVES na CRIANÇA.

IT: Non usare mai un sistema di sicurezza per bambini rivolto all'indietro su un sedile protetto da AIRBAG ATTIVO di fronte ad esso: pericolo di MORTE o LESIONI GRAVI per il BAMBINO!

EL: ΠΟΤΕ μη χρησιμοποιείτε παιδικό κάθισμα ασφαλείας με φορά προς τα πίσω σε κάθισμα που προστατεύεται από μετωπικό ΕΝΕΡΓΟ ΑΕΡΟΣΑΚΟ, διότι το παιδί μπορεί να υποστεί ΘΑΝΑΣΙΜΟ ή ΣΟΒΑΡΟ ΤΡΑΥΜΑΤΙΣΜΟ.

PL: NIE WOLNO montować fotelika dziecięcego zwróconego tyłem do kierunku jazdy na fotelu, przed którym znajduje się WŁĄCZONA PODUSZKA POWIETRZNA. Niezastosowanie się do tego

zalecenia może być przyczyną ŚMIERCI lub POWAŻNYCH OBRAŻEŃ u DZIECKA.

TR: Arkaya bakan bir çocuk emniyet sistemini KESİNLİKLE önünde bir AKTİF HAVA YASTIĞI ile korunmakta olan bir koltukta kullanmayınız. ÇOCUK ÖLEBİLİR veya AĞIR ŞEKİLDE YARALANABİLİR.

UK: НИКОЛИ не використовуйте систему безпеки для дітей, що встановлюється обличчям назад, на сидінні з УВІМКНЕНОЮ ПОДУШКОЮ БЕЗПЕКИ, інакше це може призвести до СМЕРТІ чи СЕРЙОЗНОГО ТРАВМУВАННЯ ДИТИНИ.

HU: SOHA ne használjon hátrafelé néző biztonsági gyerekülést előlről AKTÍV LÉGZSÁKKAL védett ülésen, mert a GYERMEK HALÁLÁT vagy KOMOLY SÉRÜLÉSÉT okozhatja.

HR: NIKADA nemojte koristiti sustav zadržavanja za djecu okrenut prema natrag na sjedalu s AKTIVNIM ZRAČNIM JASTUKOM ispred njega, to bi moglo dovesti do SMRTI ili OZBILJNIH OZLJEDA za DIJETE.

SL: NIKOLI ne nameščajte otroškega varnostnega sedeža, obrnjenega v nasprotni smeri vožnje, na sedež z AKTIVNO ČELNO ZRAČNO BLAZINO, saj pri tem obstaja nevarnost RESNIH ali SMRTNIH POŠKODB za OTROKA.

SR: NIKADA ne koristiti bezbednosni sistem za decu u kome su deca okrenuta unazad na sedištu sa AKTIVNIM VAZDUŠNIM JASTUKOM ispred sedišta zato što DETE može da NASTRADA ili da se TEŠKO POVREDI.

MK: НИКОГАШ не користете детско седиште свртено наназад на седиште заштитено со АКТИВНО ВОЗДУШНО ПЕРНИЧЕ пред него, затоа што детето може ДА ЗАГИНЕ или да биде ТЕШКО ПОВРЕДЕНО.

BG: НИКОГА не използвайте детска седалка, гледаща назад, върху седалка, която е защитена чрез АКТИВНА ВЪЗДУШНА ВЪЗГЛАВНИЦА пред нея - може да се стигне до СМЪРТ или СЕРИОЗНО НАРАНЯВАНЕ на ДЕТЕТО.

RO: Nu utilizați NICIODATĂ un scaun pentru copil îndreptat spre partea din spate a mașinii pe un scaun protejat de un AIRBAG ACTIV în fața sa; acest lucru poate duce la DECESUL sau VĂTĂMAREA GRAVĂ a COPILULUI.

CS: NIKDY nepoužívejte dětský zádržný systém instalovaný proti směru jízdy na sedadle, které je chráněno před sedadlem AKTIVNÍM AIRBAGEM. Mohlo by dojít k VÁŽNĚMU PORANĚNÍ nebo ÚMRTÍ DÍTĚTE.

SK: NIKDY nepoužívajte detskú sedačku otočenú vzad na sedadle chránenom AKTÍVNÝM AIRBAGOM, pretože môže dôjsť k SMRTI alebo VÁŽNYM ZRANENIAM DIEŤAŤA.

LT: JOKIU BŪDU nemontuokite atgal atgręžtos vaiko tvirtinimo sistemas sėdynėje, prieš kurią įrengta AKTYVI ORO PAGALVĖ, nes VAIKAS GALI ŽŪTI arba RIMTAI SUSIŽALOTI.

LV: NEKĀDĀ GADĪJUMĀ neizmantojiet uz aizmuguri vērstu bērnu sēdekļīti sēdvietā, kas tiek aizsargāta ar tās priekšā uzstādītu

AKTĪVU DROŠĪBAS SPILVENU, jo pretējā gadījumā BĒRNS var gūt SMAGAS TRAUMAS vai IET BOJĀ.

ET: ÄRGE kasutage tahapoole suunatud lapseturvaistet istmel, mille ees on AKTIIVSE TURVAPADJAGA kaitstud iste, sest see võib põhjustada LAPSE SURMA või TÕSISE VIGASTUSE.

MT: QATT tuża trażżin għat-*tfal* li jħares lejn in-naħa ta' wara fuq sit protett b'AIRBAG ATTIV quddiemu; dan jista' jikkawża l-MEWT jew GRIEHI SERJI lit-TFAL.

GA: Ná húsáid srian sábháilteachta linbh cúil RIAMH ar shuíochán a bhfuil mála aeir ag feidhmiú os a chomhair. Tá baol BÁIS nó GORTÚ DONA don PHÁISTE ag baint leis.

Beyond the warning required by ECE R94.02, for safety reasons a forward-facing child restraint system must only be used subject to the instructions and restrictions in the table ⇨ 53.

The airbag label is located on both sides of the front passenger sun visor.

Airbag deactivation ⇨ 49.

Front airbag system

The front airbag system consists of one airbag in the steering wheel and one in the instrument panel on the front passenger side. These can be identified by the word **AIRBAG**.

The front airbag system is triggered in the event of a front-end impact of a certain severity. The vehicle must be switched on.

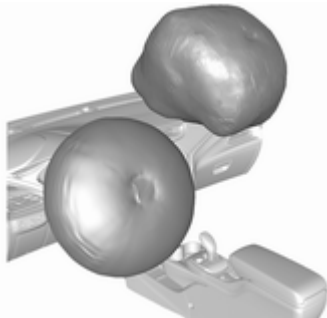

The inflated airbags cushion the impact, thereby reducing the risk of injury to the upper body and head of the front seat occupants considerably.

⚠ Warning

Optimum protection is only provided when the seat is in the proper position.

Seat position ⇨ 38.

Keep the area in which the airbag inflates clear of obstructions.

Fit the seat belt correctly and engage securely. Only then is the airbag able to protect.

Side airbag system

The side airbag system consists of an airbag in each front seat backrest. This can be identified by the word **AIRBAG**.

The side airbag system is triggered in the event of a side impact of a certain severity. The vehicle must be switched on.



The inflated airbags cushion the impact, thereby reducing the risk of injury to the upper body and pelvis in the event of a side-on collision considerably.

⚠ Warning

Keep the area in which the airbag inflates clear of obstructions.

Note

Only use protective seat covers that have been approved for the vehicle. Be careful not to cover the airbags.

Curtain airbag system

The curtain airbag system consists of an airbag in the roof frame on each side. This can be identified by the word **AIRBAG** on the roof pillars.

The curtain airbag system is triggered in the event of a side-on impact of a certain severity. The vehicle must be switched on.

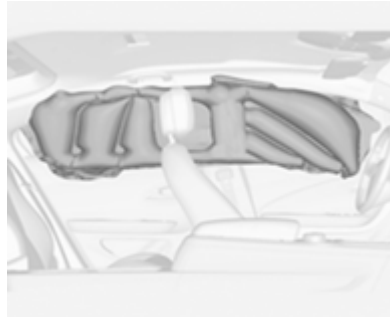

The inflated airbags cushion the impact, thereby reducing the risk of injury to the head in the event of a side-on impact considerably.

⚠ Warning

Keep the area in which the airbag inflates clear of obstructions.

The hooks on the handles in the roof frame are only suitable for hanging up light articles of clothing, without coat hangers. Do not keep any items in these clothes.



Airbag deactivation

The front passenger airbag system must be deactivated for child restraint system on the passenger seat according to the instructions in the table ↻ 53. The side airbag and curtain airbag systems, the belt pretensioners and all driver airbag systems will remain active.



The front passenger airbag system can be deactivated via a key-operated switch on the passenger side of the instrument panel.

Use the key blade to change the position:

-  OFF : front passenger airbag is deactivated and will not inflate in the event of a collision. Control indicator OFF  illuminates continuously in the overhead console
-  ON : front passenger airbag is active

Danger

Deactivate passenger airbag only in combination with the use of a child restraint system, subject to the instructions and restrictions in the table  53.

Otherwise, there is a risk of fatal injury for a person occupying a seat with a deactivated front passenger airbag.



If control indicator ON  illuminates for a certain time after the vehicle is switched on, the front passenger airbag system will inflate in the event of a collision.

If both control indicators are illuminated at the same time, there is a system failure. The status of the system is not discernible, therefore no person is allowed to occupy the front passenger seat. Contact a workshop immediately.

Consult a workshop immediately if neither of the two control indicators are illuminated.

Change status only when the vehicle is stopped with the vehicle off.

Status remains until the next change.

Control indicator for airbag deactivation  78.

Child restraints

Child restraint systems

⚠ Danger

If using a rear-facing child restraint system on the front passenger seat, the airbag system for the front passenger seat must be deactivated. This also applies to certain forward-facing child restraint systems as indicated in the tables ⇨ 53.

Airbag deactivation ⇨ 49.

Airbag label ⇨ 45.

We recommend a child restraint system which is tailored specifically to the vehicle. For further information, contact your workshop.

When a child restraint system is being used, pay attention to the following usage and installation instructions and also those supplied with the child restraint system.

Always comply with local or national regulations. In some countries, the use of child restraint systems is forbidden on certain seats.

Child restraint systems can be fastened with:

- Three-point seat belt
- ISOFIX brackets
- Top-tether

Three-point seat belt

Child restraint systems can be fastened by using a three-point seat belt. Depending on the size of the used child restraint systems, up to three child restraint systems can be attached to the rear seats. After fastening the child restraint system the seat belt has to be tightened ⇨ 53.

ISOFIX brackets



Fasten vehicle-approved ISOFIX child restraint systems to the ISOFIX mounting brackets. Specific vehicle ISOFIX child restraint system positions are marked in the ISOFIX table ⇨ 53.

ISOFIX mounting brackets are indicated by a label on the backrest.

Either a Top-tether strap or a support leg must be used in addition to the ISOFIX mounting brackets.

Top-tether anchors

Top-tether anchors are marked with the symbol  for a child seat.



In addition to the ISOFIX mounting brackets, fasten the Top-tether strap to the Top-tether anchors.

Remove the load compartment cover before mounting a child restraint system, if required ↷ 60.

ISOFIX child restraint systems of universal category positions are marked in the table by IUF ↷ 53.

Selecting the right system

The rear seats are the most convenient location to fasten a child restraint system.

Children should travel facing rearwards in the vehicle as long as possible. This makes sure that the child's backbone, which is still very weak, is under less strain in the event of an accident.

Suitable are restraint systems that comply with valid UN ECE regulations. Check local laws and regulations for mandatory use of child restraint systems.

The following child restraints are recommended for the following weight classes:

- **Group 0, Group 0+**
Maxi Cosi Cabriofix with or without ISOFIX base, for children up to 13 kg.
- **Group I**
Duo Plus with ISOFIX and Top-tether, for children from 9 kg to 18 kg.
- **Group II, Group III**
Kidfix XP with or without ISOFIX, for children from 15 kg to 25 kg.
Graco Junior, for children from 22 kg to 36 kg.

Ensure that the child restraint system to be installed is compatible with the vehicle type.

Ensure that the mounting location of the child restraint system within the vehicle is correct, see following tables.

Allow children to enter and exit the vehicle only on the side facing away from the traffic.

When the child restraint system is not in use, secure the seat with a seat belt or remove it from the vehicle.

Note

Do not affix anything on the child restraint systems and do not cover them with any other materials.

A child restraint system which has been subjected to stress in an accident must be replaced.

Child restraint installation locations

Permissible options for fastening a child restraint system with a three-point seat belt

Weight class	On front passenger seat		On rear outboard seats	On rear centre seat
	activated airbag	deactivated airbag		
Group 0: up to 10 kg	X	U ^{1,2}	U/L ³	U
Group 0+: up to 13 kg	X	U ^{1,2}	U/L ³	U
Group I: 9 to 18 kg	X	U ^{1,2,4}	U/L ^{3,4}	U ⁴
Group II: 15 to 25 kg	U ^{1,2,4}	X	U/L ^{3,4}	U ⁴
Group III: 22 to 36 kg	U ^{1,2,4}	X	U/L ^{3,4}	U ⁴

U : universal suitability in conjunction with three-point seat belt

L : suitable for particular child restraint systems of the 'specific-vehicle', 'restricted' or 'semi-universal' categories. The child restraint system must be approved for the specific vehicle type (refer to the vehicle type list of the child restraint system)

X : no child restraint system permitted in this weight class

¹ : move seat forwards as far as necessary and adjust seat backrest as far as necessary to a vertical position to ensure that the belt runs forwards from the upper anchorage point

² : move seat upwards as far as necessary and adjust seat backrest as far as necessary to a vertical position to ensure that the belt is tight on the buckle side

³ : move the respective front seat ahead of the child restraint system forwards as far as necessary

⁴ : adjust the respective headrest as necessary or remove if required

Permissible options for fitting an ISOFIX child restraint system with ISOFIX brackets

Weight class	Size class	Fixture	On front passenger seat		On rear outboard seats	On rear centre seat
			activated airbag	deactivated airbag		
Group 0: up to 10 kg	G	ISO/L2	X	X	X	X
	F	ISO/L1	X	X	X	X
	E	ISO/R1	X	X	IL ³	X
Group 0+: up to 13 kg	E	ISO/R1	X	X	IL ³	X
	D	ISO/R2	X	X	IL ³	X
	C	ISO/R3	X	X	IL ³	X
Group I: 9 to 18 kg	D	ISO/R2	X	X	IL ^{3,4}	X
	C	ISO/R3	X	X	IL ^{3,4}	X
	B	ISO/F2	X	X	IL, IUF ^{3,4}	X
	B1	ISO/F2X	X	X	IL, IUF ^{3,4}	X
	A	ISO/F3	X	X	IL, IUF ^{3,4}	X
Group II: 15 to 25 kg			X	X	IL ^{3,4}	X
Group III: 22 to 36 kg			X	X	IL ^{3,4}	X

- IL : suitable for particular ISOFIX restraint systems of the 'specific-vehicle', 'restricted' or 'semi-universal' categories. The ISOFIX restraint system must be approved for the specific vehicle type (refer to the vehicle type list of the child restraint system)
- IUF : suitable for ISOFIX forward-facing child restraint systems of universal category approved for use in this weight class
- X : no ISOFIX child restraint system approved in this weight class
- 1 : move seat forwards as far as necessary and adjust seat backrest as far as necessary to a vertical position to ensure that the belt runs forwards from the upper anchorage point
- 2 : move seat upwards as far as necessary and adjust seat backrest as far as necessary to a vertical position to ensure that the belt is tight on the buckle side
- 3 : move the respective front seat ahead of the child restraint system forwards as far as necessary and adjust seat backrest as far as necessary to a vertical position
- 4 : adjust the respective headrest as necessary or remove if required

ISOFIX size class and seat device

- A – ISO/F3 : forward-facing child restraint system for children of maximum size in the weight class 9 to 18 kg
- B – ISO/F2 : forward-facing child restraint system for smaller children in the weight class 9 to 18 kg
- B1 – ISO/F2X : forward-facing child restraint system for smaller children in the weight class 9 to 18 kg
- C – ISO/R3 : rear-facing child restraint system for children of maximum size in the weight class up to 18 kg
- D – ISO/R2 : rear-facing child restraint system for smaller children in the weight class up to 18 kg
- E – ISO/R1 : rear-facing child restraint system for young children in the weight class up to 13 kg
- F – ISO/L1 : left lateral facing position child restraint system (carry-cot)
- G – ISO/L2 : right lateral facing position child restraint system (carry-cot)

Permissible options for fitting an i-Size child restraint system with ISOFIX brackets

	On front passenger seat		On rear outboard seats	On rear centre seat
	activated airbag	deactivated airbag		
i-Size child restraint systems	X	X	X	X

X : seating position not suitable for i-Size 'universal' child restraint systems

Storage

Storage compartments	57
Glovebox	57
Cupholders	57
Armrest storage	58
Centre console storage	58
Load compartment	59
Load compartment cover	60
Rear floor storage cover	60
Lashing eyes	61
Warning triangle	61
First aid kit	61
Roof rack system	62
Roof rack	62
Loading information	62

Storage compartments

⚠ Warning

Do not store heavy or sharp objects in the storage compartments. Otherwise, the storage compartment lid could open and vehicle occupants could be injured by objects being thrown around in the event of hard braking, a sudden change in direction or an accident.

Glovebox



To open the glovebox, pull the handle.

The glovebox should be closed whilst driving.

Cupholders



Cupholders are located in the centre console.

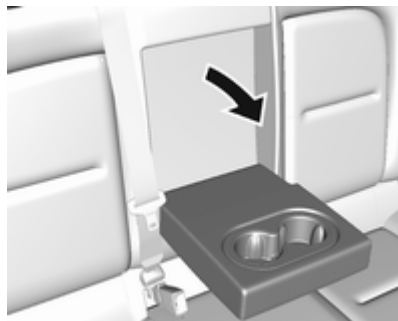

Additional cupholders are located in the rear armrest. Fold down armrest.

Armrest storage

Storage under the front armrest

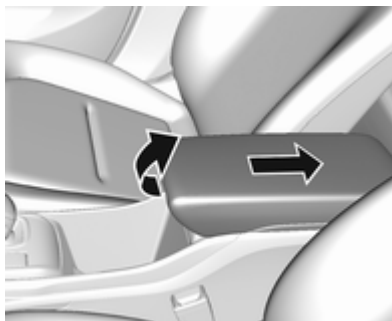

Press button to fold up the armrest. The armrest must be in rearmost position.

Centre console storage

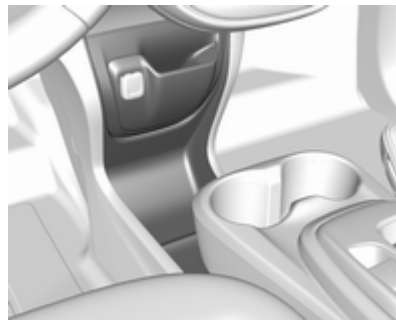

A storage compartment is located in the centre console.

Load compartment

Load compartment extension

The rear seat backrest is divided into two parts. Both parts can be folded down.

Remove the load compartment cover if necessary ⇨ 60.

Press and hold the catch, then push the head restraints down ⇨ 37.

Fold up the rear armrest.



Guide the seat belts of the outer seats into the belt guides.



Pull the release lever on one or both outer sides and fold down the backrests onto the seat cushion.

To fold up, raise the backrests and guide them into an upright position until they engage audibly.

Make sure the seat belt is in the belt guide and is not twisted or caught in the behind of backrests.



The backrests are properly engaged when the red mark near the release lever is no longer visible.

Warning

When folding up, ensure that backrests are securely locked in position before driving. Failure to do so may result in personal injury or damage to the load or vehicle in the event of hard braking or a collision.



The seat belt of the centre seat could be blocked when the backrest is folded up too quickly. To unlock the retractor, push in the seat belt or pull it out by approx. 20 mm then release.

Load compartment cover

Do not place any objects on the cover.

Removing

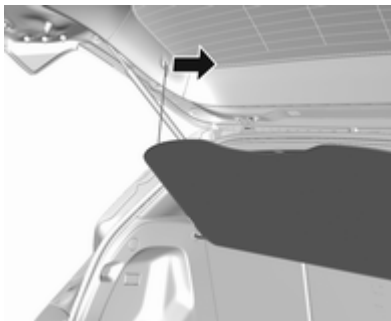

Unhook retaining strings from tailgate.

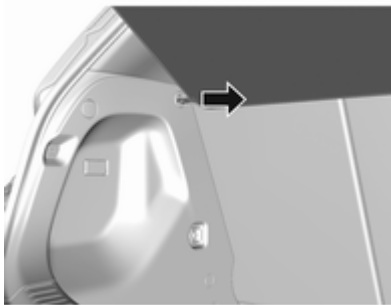

Unhook retaining strings from the sidewalls of load compartment.

Remove the cover.

Fitting

Attach retaining strings to the sidewalls of load compartment and tailgate.

Rear floor storage cover

Rear floor cover

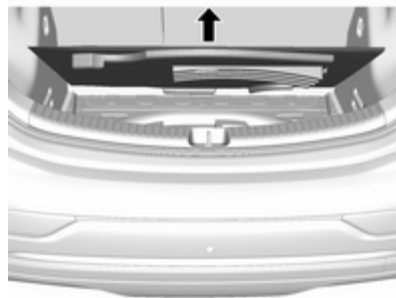

Lift up rear floor cover to gain access to the charge cord, vehicle tools and warning triangle.

General hint

Warning

For safety reasons, stow all parts in the load compartment in its position, always drive with a closed rear floor cover and, if possible, with folded up rear backrests.

Otherwise, vehicle occupants could be injured by objects being thrown around in the event of sharp braking, a sudden change in direction or an accident.

Lashing eyes

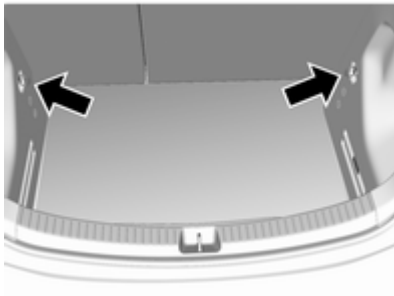

The lashing eyes are designed to secure items against slippage, e.g. using lashing straps or luggage net.

Warning triangle

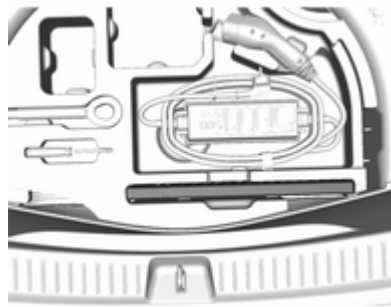

Stow the warning triangle in the vehicle tool box below the rear floor cover in the load compartment.

First aid kit



Stow the first-aid kit in the load compartment.

Roof rack system

Roof rack

For safety reasons and to avoid damage to the roof, the vehicle approved roof rack system is recommended. For further information contact your workshop.

Follow the installation instructions and remove the roof rack when not in use.

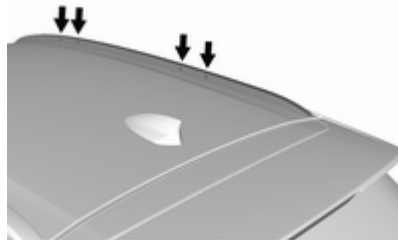

To fasten the roof rack, insert the mounting bolts in the holes indicated in the figure.

Loading information

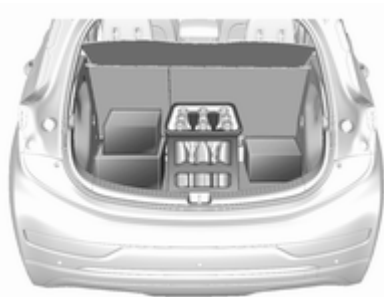

- Heavy objects in the load compartment should be placed against the seat backrests. Make sure that the backrests are securely engaged, i.e. no longer showing the red markings near the release lever. If objects can be stacked, heavier objects should be placed at the bottom.
- Prevent sliding of loose objects by securing them with straps attached to the lashing eyes ↪ 61.

- Do not allow the load to protrude above the upper edge of the backrests.
- Do not place any objects on the load compartment cover or the instrument panel, and do not cover the sensor on top of the instrument panel.
- The load must not obstruct the operation of the pedals, parking brake and selector lever, or hinder the freedom of movement of the driver. Do not place any unsecured objects in the interior.
- Do not drive with an open load compartment.

⚠ Warning

Always make sure that the load in the vehicle is securely stowed. Otherwise objects can be thrown around inside the vehicle and cause personal injury or damage to the load or car.

- The payload is the difference between the permitted gross vehicle weight (see identification

plate ⇨ 249) and the EC kerb weight.

The EC kerb weight includes weights for the driver (68 kg), luggage (7 kg) and all fluids.

Optional equipment and accessories increase the kerb weight.

- Driving with a roof load increases the sensitivity of the vehicle to cross-winds and has a detrimental effect on vehicle handling due to the vehicle's higher centre of gravity.

Distribute the load evenly and secure it properly with retaining straps. Adjust the tyre pressure and vehicle speed according to the load conditions. Check and retighten the straps frequently.

Do not drive faster than 120 km/h.

The permissible roof load is 50 kg. The roof load is the combined weight of the roof rack and the load.

Instruments and controls

Controls	65
Steering wheel adjustment	65
Steering wheel controls	65
Heated steering wheel	65
Horn	66
Pedestrian safety alert	66
Windscreen wiper and washer ..	66
Rear window wiper and washer	68
Outside temperature	68
Clock	69
Power outlets	69
Inductive charging	70
Warning lights, gauges and indicators	72
Instrument cluster	72
Speedometer	74
Odometer	74
Battery gauge	74
Driving efficiency gauge	74
Power indicator gauge	76
Regenerative braking	76
Total vehicle range	77
Service display	77

Control indicators	77
Turn lights	77
Seat belt reminder	77
Airbag and belt tensioners	78
Airbag deactivation	78
Charging system	78
Service vehicle soon	79
Brake system	79
Electric parking brake	79
Electric parking brake fault	79
Antilock brake system (ABS)	79
Sport mode	80
Lane keep assist	80
Electronic Stability Control off ..	80
Electronic Stability Control and Traction Control system	80
Traction Control system off	80
Tyre pressure monitoring system	80
Immobiliser	81
Vehicle ready	81
Exterior light	81
High beam	81
High beam assist	81
Rear fog light	81
Cruise control	81
Vehicle detected ahead	81
Pedestrian detection	81
Speed limiter	81

Traffic sign assistant	82
Door open	82
Displays	82
Driver Information Centre	82
Info Display	85
Vehicle messages	89
Warning chimes	90
Battery voltage	90
Vehicle personalisation	90
Telematics service	93
OnStar	93

Controls

Steering wheel adjustment



Unlock lever, adjust steering wheel, then engage lever and ensure it is fully locked.

Do not adjust steering wheel unless vehicle is stationary and steering wheel lock has been released.

Steering wheel controls

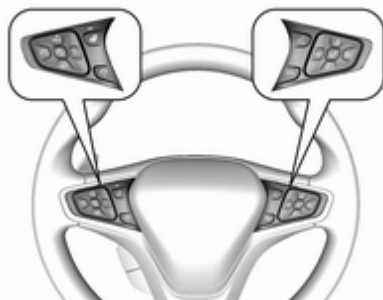

Cruise control and speed limiter are operated via the controls on the left side of the steering wheel.

Additionally, forward collision alert can be set by using the controls on the left side of the steering wheel.

Infotainment system can be operated via the controls on the right side of the steering wheel.

Driver assistance systems ⇨ 163.

Infotainment system ⇨ 105.

Heated steering wheel



Activate heating by pressing . Activation is indicated by the LED in the button.



The recommended grip areas of the steering wheel are heated quicker and to a higher temperature than the other areas.

Heating is operational after the vehicle has been started.

Auto heated steering wheel

The heated steering wheel will turn on automatically in remote start along with the heated seats when it is cold outside. The heated steering wheel indicator light may not come on.

The heated steering wheel will not switch on during a remote start unless the heated seat feature is enabled in the vehicle settings.

Vehicle personalisation ⇨ 90.

Horn

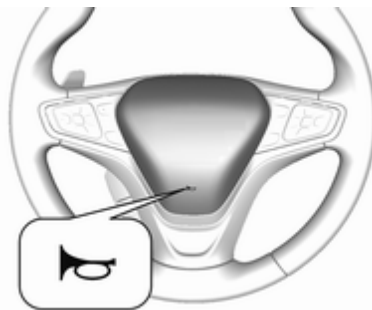

Press .

Pedestrian safety alert

Pedestrian safety signal enables the driver to alert people who may not hear the vehicle approaching.

The automatic sound is generated to indicate the vehicle presence to pedestrians. The sound changes if the vehicle is speeding up or slowing down. It is activated when the vehicle is shifted into a forward gear or **R**, up to 23 km/h.

This feature can be deactivated in the vehicle settings.

Vehicle personalisation ⇨ 90.

Windscreen wiper and washer

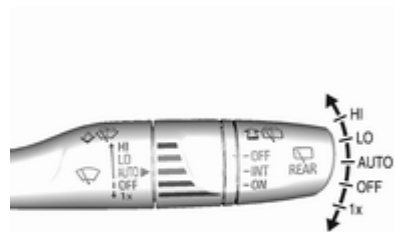

- HI** : fast
- LO** : slow
- AUTO** : automatic wiping with rain sensor
- OFF** : off

In **AUTO** position, the rain sensor detects the amount of water on the windscreen and automatically regulates the frequency of the windscreen wiper.

For a single wipe when the windscreen wiper is off, press the lever downwards to position **1x**.

Do not use if the windscreen is frozen.
Switch off in car washes.

Adjustable sensitivity of the rain sensor

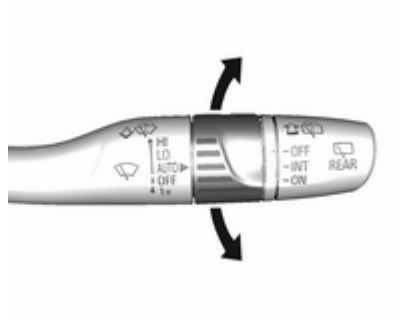

Wiper lever in position **AUTO**.

Turn the adjuster wheel to adjust the sensitivity of the rain sensor.

Low sensitivity: turn adjuster wheel downwards

High sensitivity: turn adjuster wheel upwards

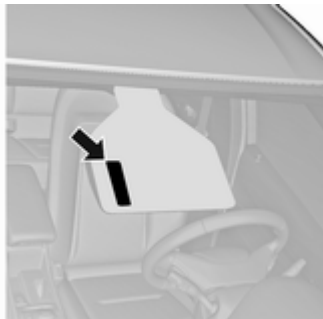

Keep the sensor free from dust, dirt and ice.

Windscreen washer

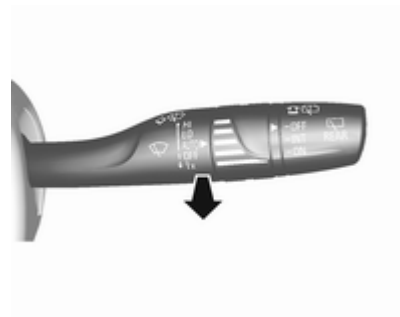

Pull lever. Washer fluid is sprayed onto the windscreen and the wiper wipes a few times.

Washer fluid ⇨ 215.

Rear window wiper and washer

Rear window wiper



Turn outer cap to activate the rear window wiper:

OFF : off

INT : intermittent operation

ON : continuous operation

Do not use if the rear window is frozen.

Switch off in car washes.

The rear window wiper comes on automatically when the windscreen wiper is switched on and reverse gear is engaged.

Activation or deactivation of this function can be changed in the menu **Settings** in the Info Display.

Vehicle personalisation ⇨ 90.

Rear window washer



Push lever.

Washer fluid is sprayed onto the rear window and the wiper wipes a few times.

If the rear camera mirror is equipped, the washer fluid is sprayed on the rear camera at the same time.

Washer fluid ⇨ 215.

Outside temperature

A drop in temperature is indicated immediately and a rise in temperature after a time delay.



If outside temperature drops to 0.5 °C, a warning message is displayed in the Driver Information Centre.

⚠ Warning

The road surface may already be icy even though the display indicates a few degrees above 0 °C.

Clock

Date and time are shown in the Info Display.

Info Display ⇨ 85.

Press  and then touch .

Select **Settings** and then select **Time and date** to display the respective submenu.



Auto set

To choose whether time and date are to be set automatically or manually, select **Auto set**.

For time and date to be set automatically, select **On - RDS**.

For time and date to be set manually, select **Off - Manual**. If **Auto set** is set to **Off - Manual**, the submenu items **Set time** and **Set date** become available.

Set time

To adjust the time settings, select **Set time**.

Touch **+** or **-** to adjust the settings.

To select a time mode, select **12 hr** or **24 hr** format.

If 12 hour format is selected, touch **▲** or **▼** to adjust **AM** or **PM**.

Set date

To adjust the date settings, select **Set date**.

Touch **+** or **-** to adjust the settings.

Power outlets



A 12 V power outlet is located in the centre console.

Do not exceed the maximum power consumption of 240 W.

With the vehicle off, the power outlet is deactivated. Additionally, the power outlet is deactivated in the event of low vehicle battery voltage.

Electrical accessories that are connected must comply with the electromagnetic compatibility requirements laid down in DIN VDE 40 839.

Do not connect any current-delivering accessories, e.g. electrical charging devices or batteries.

Do not damage the outlets by using unsuitable plugs.

USB charging ports



Two USB ports are located in the centre console. These ports can be used for charging and Infotainment connection.

External devices ↗ 125.

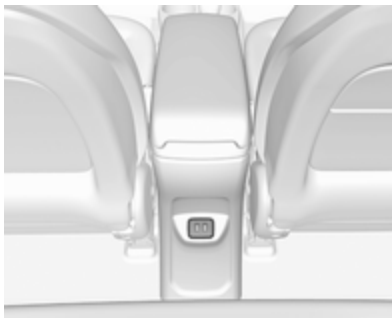

Another two USB ports for charging only are located in the back of the centre console.

All USB ports provide 2.1 A at 5 V.

Note

The USB ports must always be kept clean and dry.

Inductive charging

⚠ Warning

Inductive charging can affect the operation of implanted pacemakers or other medical

devices. If applicable, seek medical advice before using the inductive charging device.

⚠ Warning

Remove any metal objects from the charging device before charging a mobile device, as these objects could become very hot.

Qi compatible mobile devices can be charged inductively.

A protective cover for the mobile device could have an impact on the inductive charging.

The vehicle must be switched on, in service mode or retained power off.

Starting and stopping the vehicle
↗ 150.

The operating temperature is $-20\text{ }^{\circ}\text{C}$ to $60\text{ }^{\circ}\text{C}$ for the charging system and $0\text{ }^{\circ}\text{C}$ to $35\text{ }^{\circ}\text{C}$ for the mobile device.



























To charge a mobile device:



1. Remove all objects from the charging slot. The system may not charge if there are any objects in the charging slot.
2. With the mobile device screen facing the driver, slowly insert the device into the charging slot until  is shown on the Info Display. This indicates that the mobile device is properly positioned and could be charged.

If a device is inserted into the slot and  is not displayed, remove the mobile device from the pocket, turn it 180°, and wait 3 seconds before inserting the device into the slot again.

Overview

-  Turn lights ⇨ 77
-  Seat belt reminder ⇨ 77
-  Airbag and belt tensioners ⇨ 78
-  Airbag deactivation ⇨ 78
-  Charging system ⇨ 78
-  Service vehicle soon ⇨ 79
-  Brake system ⇨ 79
-  Electric parking brake ⇨ 79
-  Electric parking brake fault ⇨ 79
-  Antilock brake system (ABS) ⇨ 79
- SPORT** Sport mode ⇨ 80
-  Lane keep assist ⇨ 80
-  Electronic Stability Control off ⇨ 80

-  Electronic Stability Control and Traction Control system ⇨ 80
-  Traction Control system off ⇨ 80
-  Tyre pressure monitoring system ⇨ 80
-  Immobiliser ⇨ 81
-  Vehicle ready ⇨ 81
-  Exterior light ⇨ 81
-  High beam ⇨ 81
-  High beam assist ⇨ 81
-  Rear fog light ⇨ 81
-  Cruise control ⇨ 81
-  Vehicle detected ahead ⇨ 81
-  Pedestrian detection ⇨ 81
-  Speed limiter ⇨ 81

-  Traffic sign assistant ⇨ 82
-  Door open ⇨ 82

Reconfigurable instrument cluster

The cluster layout can be changed. Use the steering wheel control to move between the different display zones and scroll through the different displays.

There are three display configurations to choose from:

- **Basic** configuration displays the speedometer with a simplified high voltage battery gauge and efficiency light.
- **Standard** configuration displays the speedometer with a high voltage battery gauge and efficiency gauge.
- **Enhanced** configuration displays the speedometer with high voltage battery gauge, efficiency ring, and power gauge.

Driver Information Centre ⇨ 82.

Speedometer



Indicates vehicle speed.

Odometer



The total recorded distance is displayed in km.

Battery gauge



This displays the high voltage battery state of charge. The value in the centre is an estimate of how far the vehicle can be driven on the remaining charge based on driving habits and conditions learned over several days.

The maximum value is shown above the display and the minimum value below the display. The values indicate the longest and shortest

possible range as estimated from current vehicle conditions and climate settings.

The mileage estimate and maximum and minimum numbers are affected by climate control system usage. Estimated range may increase or decrease based on changes in climate control energy consumption.

A trend bar on the far left indicates how recent driving habits, vehicle conditions and climate settings are affecting the range prediction.

When the high voltage battery state of charge is very low the estimated range value in the centre will change to **Low**. Maximum and minimum ranges will no longer be displayed. Additional alerts may display and a sound may also be heard at low state of charge.

Driving efficiency gauge

This gauge is a guide to driving in an efficient manner.

Driving economically ⇨ 147.

Efficient driving

Efficient driving is indicated by:



- Basic layout: keeping the gauge and the leaf green.



- Standard layout: keeping the ball green and in the centre of the gauge.

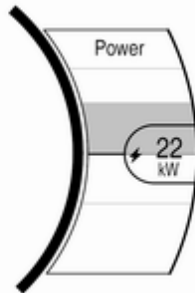

- Enhanced layout: keeping the outer ring of the speedometer green.

Inefficient acceleration

Inefficient acceleration is indicated by:

- Basic layout: the gauge and the leaf turn yellow.
- Standard layout: the ball turns yellow and moves to the top end.
- Enhanced layout: the outer ring of the speedometer turns yellow and the gauge moves to the top end.

Aggressive braking

Aggressive braking is indicated by:

- Basic layout: the gauge and the leaf turn yellow.
- Standard layout: the ball turns yellow and moves to the bottom end.
- Enhanced layout: the outer ring of the speedometer turns yellow and the gauge moves to the bottom end.

Driving economically ⇨ 147.

Driver Information Centre ⇨ 82.

Power indicator gauge

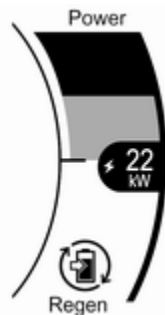

The power indicator gauge displays the instantaneous charge and discharge power flowing either into or out of the high voltage battery. Maximum discharge power is available when the high voltage battery is fully charged. During normal operation, a slight reduction in discharge power may occur as the high voltage battery state of charge decreases.

Regenerative braking



There is an indication when regenerative braking is active. If regenerative braking is active, the regenerative active icon with arrows is shown as green.

Regenerative power limited indication



Regenerative power icon is shown as grey when regenerative power is limited. Additionally, a horizontal bar is displayed on the gauge. This usually occurs when the high voltage battery is near full charge or cold. Regenerative braking ⇨ 160.

Total vehicle range



Displays the total vehicle range.

Driving economically ⇨ 147.

Service display

If it is time for service, a message is displayed in the Driver Information Centre.

The first warning is displayed 400 km before service is due and the second warning 80 km before the service is due. The message appears every time the vehicle is switched on.

The message can be dismissed or reset. Reset after service only.

Driver Information Centre ⇨ 82.

Control indicators

The control indicators described are not present in all vehicles. The description applies to all instrument versions. Depending on the equipment, the position of the control indicators may vary. When the vehicle is switched on, most control indicators will illuminate briefly as a functionality test.

The control indicator colours mean:

- red : danger, important reminder
- yellow : warning, information, fault
- green : confirmation of activation
- blue : confirmation of activation
- white : confirmation of activation, system ready

Control indicators ⇨ 72.

Turn lights

⇨ illuminates or flashes green.

Illuminates briefly

The parking lights are switched on.

Flashes

A turn light or the hazard warning flashers are activated.

Rapid flashing: failure of a turn light or associated fuse.

Bulb replacement ⇨ 219.

Fuses ⇨ 222.

Turn lights ⇨ 102.

Seat belt reminder

Seat belt reminder on front seats

⚠ for driver's seat illuminates or flashes red in the instrument cluster.



⚡ for front passenger seat illuminates or flashes red in the overhead console, when seat is occupied.

Illuminates

After the vehicle has been switched on until the seat belt has been fastened.

Flashes

After having started the propulsion system for a certain time until the seat belt has been fastened.

Fastening the seat belt ⇨ 43.

Airbag and belt tensioners

⚡ illuminates red.

When the vehicle is switched on, the control indicator illuminates for several seconds. If it does not illuminate, does not go out after 4 seconds or illuminates whilst driving, there is a fault in the airbag system.

Seek the assistance of a workshop.

The airbags and belt pretensioners may fail to trigger in the event of an accident.

If there is a problem with the airbag system, a Driver Information Centre message may also come on. Deployment of the belt pretensioners or airbags is indicated by continuous illumination of ⚡.

⚠ Warning

Have the cause of the fault remedied immediately by a workshop.

Belt pretensioners ⇨ 42.

Airbag system ⇨ 45.

Driver Information Centre ⇨ 82.

Airbag deactivation



⚡ illuminates yellow.

The front passenger airbag is activated.

⚡ illuminates yellow.

The front passenger airbag is deactivated.

Airbag deactivation ⇨ 49.

Charging system

⚡ illuminates red.

Illuminates when the vehicle is switched on and extinguishes shortly after the propulsion system starts.

Illuminates when the propulsion system is on

1. Move out of the flow of traffic as quickly as possible without impeding other vehicles.
2. Stop, switch off the vehicle.
3. Seek the assistance of a workshop.

Driving while  illuminates could drain the 12 V vehicle battery.

Starting and stopping the vehicle
↻ 150.

Service vehicle soon

 illuminates yellow.

Fault in the vehicle. Seek the assistance of a workshop immediately.

Brake system

 illuminates red.

Illuminates after the vehicle is switched on. The brake fluid level is too low or any other problem with the brake system exists.

Brake fluid level ↻ 215.

Warning

Stop. Do not continue your journey. Consult a workshop.

Electric parking brake

 illuminates or flashes red.

Illuminates

Electric parking brake is applied
↻ 158.

Flashes

Electric parking brake is not fully applied or released. Depress the brake pedal and attempt to reset the system by first releasing then applying the electric parking brake. If  remains flashing, do not drive and seek the assistance of a workshop.

Electric parking brake fault

 illuminates or flashes yellow.

Illuminates

Electric parking brake is operating with degraded performance ↻ 158.

Flashes

Electric parking brake is in service mode. Stop vehicle, apply and release the electric parking brake to reset.

Warning

Have the cause of the fault remedied immediately by a workshop. Avoid parking on inclines until the cause of the fault has been remedied.

An error message may be displayed in the Driver Information Centre
↻ 82.

Antilock brake system (ABS)

 illuminates yellow.

Illuminates for a few seconds after the vehicle is switched on. The system is ready for operation when the control indicator extinguishes.

If the control indicator does not go out after a few seconds, or if it illuminates while driving, there is a fault in the

ABS. The brake system remains operational but without ABS regulation.

Antilock brake system ⇨ 157.

Sport mode

SPORT illuminates when Sport mode is selected.

Sport mode ⇨ 153.

Lane keep assist

 illuminates green or yellow, or flashes yellow.

Illuminates green

The system is switched on and ready to operate.

Illuminates yellow

The system approaches a detected lane marking without using the turn light in that direction.

Flashes yellow

The system recognises that the lane is departed significantly.

Lane keep assist ⇨ 190.

Electronic Stability Control off

 illuminates yellow.

The system is deactivated.

Electronic Stability Control ⇨ 162.

Electronic Stability Control and Traction Control system

 illuminates or flashes yellow.

Illuminates

A fault in the system is present. Continued driving is possible. Driving stability, however, may deteriorate depending on road surface conditions.

Have the cause of the fault remedied by a workshop.

Flashes

The system is active and is working to assist the driver with directional control of the vehicle in difficult driving conditions.

Electronic Stability Control ⇨ 162.

Traction Control system ⇨ 161.

Traction Control system off

 illuminates yellow.

The system is deactivated.

Traction Control system ⇨ 161.

Tyre pressure monitoring system

 illuminates or flashes yellow.

Illuminates

Tyre pressure loss. Stop immediately and check tyre pressure.

Flashes

Fault in system or tyre without pressure sensor mounted (e.g. spare wheel). After 60 to 90 seconds the control indicator illuminates continuously. Consult a workshop.

Tyre pressure monitoring system ⇨ 232.

Immobiliser

 illuminates yellow.

Fault in the immobiliser system. The propulsion system cannot be started.

Seek the assistance of a workshop.

Immobiliser ⇨ 31.

Vehicle ready

 illuminates green. The vehicle is ready to be driven.

Starting and stopping the vehicle ⇨ 150.

Exterior light

 illuminates green.

The exterior lights are on ⇨ 98.

High beam

 illuminates blue.

Illuminated when high beam is on or during headlight flash ⇨ 99.

High beam assist

 illuminates green.

The high beam assist is activated ⇨ 100.

Rear fog light

 illuminates yellow.

The rear fog light is on ⇨ 102.

Cruise control

 illuminates white or green.

Illuminates white

The system is on.

Illuminates green

Cruise control is active.

Cruise control ⇨ 163.

Vehicle detected ahead

 illuminates green or yellow.

Illuminates green

A vehicle ahead is detected in the same lane.

Illuminates yellow

The distance to a preceding moving vehicle gets too small or when approaching another vehicle too rapidly.

Forward collision alert ⇨ 166.

Pedestrian detection

 illuminates yellow.

A pedestrian ahead is detected.

Front pedestrian protection ⇨ 171.

Speed limiter

 illuminates white or green.

Illuminates white

The system is on.

Illuminates green

Speed limiter is active. Set speed is indicated near  symbol.

Speed limiter ⇨ 164.

Traffic sign assistant

Ⓜ displays detected traffic signs as control indicator.

Traffic sign assistant ⇨ 187.

Door open

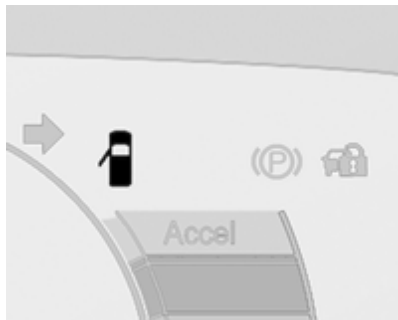

The indicator shows if a door, the bonnet or the tailgate is open. The symbol changes accordingly.

An additional graphic is shown in the Driver Information Centre every time the bonnet or the tailgate are opened.

Driver Information Centre ⇨ 82.

Displays

Driver Information Centre

The Driver Information Centre is located in the instrument cluster.

Driver Information Centre indicates depending on the equipment:

- overall and trip odometer
- vehicle information
- trip information
- driving economy information
- vehicle and warning messages
- audio and Infotainment information
- phone information
- vehicle settings

Menu pages are indicated by pressing ◀ on the steering wheel.

Press ▲ or ▼ to select a menu, press ✓ to confirm. Selectable menu pages are:

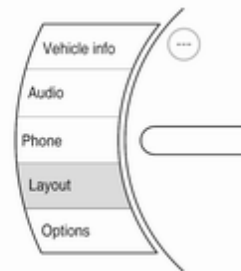

- **Vehicle info**
- **Audio**
- **Phone**
- **Layout**
- **Options**

Some of the displayed functions differ when the vehicle is being driven or at a standstill. Some functions are only available when the vehicle is at a standstill.

Selecting menus and functions

The menus and functions can be selected via the buttons on the right side of the steering wheel.



- Press \triangleleft to open main menu page.
- Select a main menu page with \triangle or ∇ .
- Confirm a main menu page with \checkmark .

Once a main menu page is selected, press \triangle or ∇ to select subpages.

- Press \triangleright to open the next folder of the selected subpage.
- Press \triangle or ∇ to select functions or to set a numeric value, if required.
- Press \checkmark to select and confirm a function.

Vehicle and service messages pop-up in the Driver Information Centre when required.

Confirm messages by pressing \checkmark .

Vehicle messages \diamond 89.

Vehicle info

The following list contains all possible **Vehicle info** menu pages. Some may not be available for your particular vehicle. Depending on the display, some functions are symbolised.

Press \triangle or ∇ to select a page:

- Trip
- Tyre pressure (kPa)
- Average speed
- Timer
- Traffic sign assistant
- Following distance
- Blank page

Trip

Trip odometer displays the current distance and the current average electrical energy economy since a certain reset.

The distance counts up to 99,999.9 km then restarts at 0.

The average electrical energy economy displays the approximate average kWh per 100 km (kWh/100 km).

To reset, press and hold \checkmark .

Tyre pressure (kPa)

Checks tyre pressure of all wheels during driving \diamond 232.

Average speed

Display of average speed. The measurement can be reset at any time.

Timer

To start and stop, press \checkmark . To reset, press \triangleright and confirm reset.

Traffic sign assistant

Displays the detected traffic signs for the current route section \diamond 187.

Following distance

Displays the distance in seconds to a preceding moving vehicle \diamond 168.

Blank page

Shows a blank page without any information.

Audio menu

In the main view of the **Audio** application, press \triangle or ∇ to scroll through radio stations or move to the next / previous track of a USB / Bluetooth® device that is connected to the vehicle.

Press \checkmark to select the Audio app, then press \triangleright to enter the **Audio** menu. In the **Audio** menu browse for music, select from the favourites, or change the audio source.

Exit the **Audio** menu by pressing \checkmark or \triangleleft .

Phone menu

Press \checkmark to select the **Phone** application, then press \triangleright to enter the **Phone** menu. In the **Phone** menu, if there is no active phone call, view recent calls, scroll through contacts, or select from the favourites. If there

is an active call, mute or unmute the phone or switch to handset or hands free operation.

Exit the **Phone** menu by pressing \checkmark or \triangleleft .

Layout menu

Press \checkmark while display themes is displayed. Select **Basic**, **Standard** or **Enhanced** mode by pressing \checkmark .

Options menu

The following list contains all possible **Options** menu pages:

- Unit
- Speed warning
- Tyre load

Units

Press \triangleright while units page is displayed.

Select imperial or metric units by pressing \checkmark .

Speed warning

The speed warning function alerts the driver when a set speed is exceeded.

To set the speed warning, press \checkmark while the page is displayed. Press \triangleright and \triangle or ∇ to adjust the value. Press \checkmark to set the speed. Once the speed is set, this feature can be turned off by pressing \checkmark while viewing this page. If the selected speed limit is exceeded, a pop-up warning is displayed with a chime.

Tyre load

The tyre pressure category according to the actual tyre inflation pressure can be selected \leftrightarrow 232.

Press \triangle or ∇ to select a category **Light**, **Eco** or **Max**.

Press \checkmark to confirm category.

Help

Provides information about the gauges which are available in the different layouts (**Basic**, **Standard** or **Enhanced**).

Open source software

System settings \leftrightarrow 116.

Info Display



The Info Display can indicate:

- climate control ↗ 141
- Infotainment system ↗ 107
- settings for vehicle personalisation ↗ 90
- power flow information
- programmable charging settings
- energy information
- indication of rear view camera ↗ 184
- outside temperature ↗ 68
- indication of parking assist instructions ↗ 173

Selecting menus and settings

Menus and settings are accessed via the display.



- Touch  to display the homepage.
- Touch required menu display icon.
- Touch a respective icon to confirm a selection.
- Touch  to return to the next higher menu level.
- Touch  to return to the homepage.

Control elements overview ↗ 107.

Vehicle personalisation ↗ 90.

Energy

Shows energy applications provided by the system.

1. Touch **Energy**.
2. Select the desired menu.



Communication error

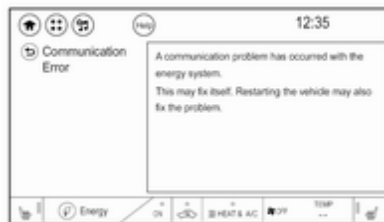

If a communication problem has occurred with the energy system, the error message is displayed. In this case, please try restarting the vehicle or contact a workshop.

Flow

This menu displays energy flow between the electric drive unit and the high voltage battery.

1. Touch **Energy**.
2. Touch **Flow**.

The components will be highlighted when they are active.

Power off

No power is flowing to the wheels.
The high voltage battery scale colour is greyed out.

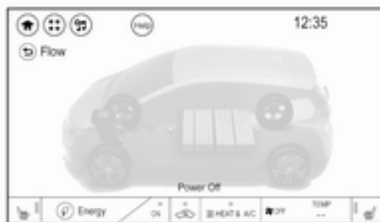

Power

The arrow indicates from high voltage battery to wheel.

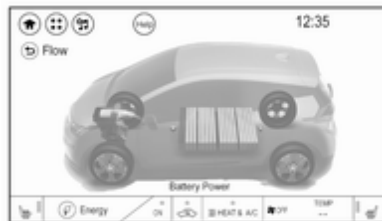

Regenerate

Power from the wheels returns to the high voltage battery during regenerative braking or coasting.

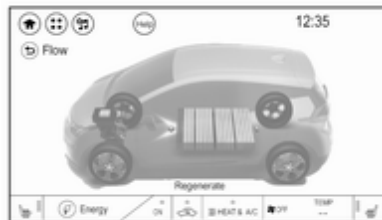

High voltage battery power

High voltage battery power is active with energy flowing to the wheels or no power is flowing to the wheel when vehicle is stationary.

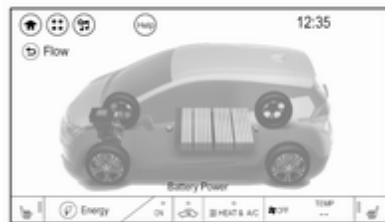

Charging

Charge mode selection ⇨ 196.

Programmable charging

Programmable charging ⇨ 196.

Energy information

To view **Energy details**, **Range Impacts Since Last Full Charge** and **Efficiency History** touch **Energy** and then **Information**. Touch < or > to go to the next screen.

Energy details



The **Energy details** screen displays how energy is being used since the last time the high voltage battery was fully charged. It includes **Driving and accessories**, **Climate settings** and **Battery conditioning**. The circle graph

displays these percentages. **Energy used** and **Distance travelled** are also displayed on the screen.

Range Impacts Since Last Full Charge

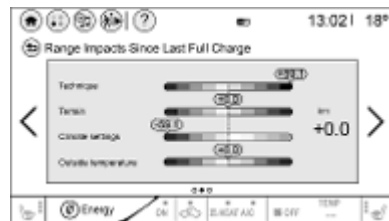

This screen provides an estimate of the factors that influence energy usage since the last full charge of the high voltage battery. A positive number is desired to reach the vehicle's electric economy rating.

- **Technique** includes speed, acceleration, and braking.
- **Terrain** includes road conditions, such as hills, rain, and snow and may be affected by wind and tyre pressure.

- **Climate settings** includes how the heating and air conditioning are used. Using fan only settings will help reduce your climate setting losses.
- **Outside temperature** includes the effect that hot or cold air has on vehicle aerodynamics.

The individual vehicle range impacts provide an understanding of how electric economy are different from day-to-day, even when travelling the same route.

All values are reset after a complete charge and may not be stable until approximately 16 km have been driven.

Efficiency History

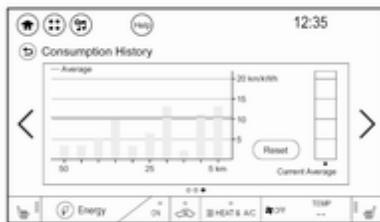

The **Efficiency History** graph shows the average economy over the last 50 km.

The present bar provides the average economy for the current 5 km.

Touch **Reset** to clear the history data.

Charging Options

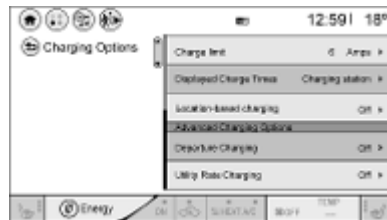

To view and change the **Charging Options**, touch **Energy** and then **Charging Options**. Use the arrows to scroll through the list.

The following list of menu items may be available:

- **Charge limit:** This feature allows the vehicle's charge level to be selected so it matches the capability of the charging location.
- **Displayed Charge Times:** This feature determines how the charge times are displayed on the charge mode status screen.
- **Location-based charging:** This feature allows the charging settings to be remembered at the

saved GPS coordinates for the **Home** location.

Location based charging in Programmable charging ⇨ 196.

- **Departure Charging:** This feature allows charging during the least expensive rate periods to achieve a full battery charge by the departure time.
- **Utility Rate Charging:** The vehicle estimates the charging start time based on the utility rate schedule, utility rate preference, and programmed departure time for the current day of the week.
- **Energy summary pop-up:** Set the energy summary pop-up feature to **On** or **Off**.
- **Charge status feedback:** Set the charge status feedback feature to **Horn chirps** or **Off**.
- **Charge power loss alert:** This feature allows an alert to sound when the vehicle is charging and

loses power at the electrical outlet. Set the charge power loss alert feature to **On** or **Off**.

- **Radio power down:** This allows high voltage battery power to be conserved. Set the value for the reminder to be displayed. To set high voltage battery charge level for **Radio power down**, touch **Energy**, then **Charging Options**, then **Radio power down**. Select **Off**, **2%**, **4%**, **6%**, **8%**, **10%**.

Low power mode

This allows high voltage battery power to be conserved.

1. Press and hold **⏻** of the Infotainment system.
2. Touch **Yes** on the Info Display. The screen will turn off.
3. Press **⏻** again to turn the display on.

Vehicle messages

Messages are indicated in the Driver Information Centre, in some cases together with a warning chime.



Press **✓** on the steering wheel to confirm a message.

Vehicle and service messages

The vehicle messages are displayed as text. Follow the instructions given in the messages.

Some important messages may appear additionally in the Info Display. Some messages only pop-up for a few seconds.

Warning chimes

If several warnings appear at the same time, only one warning chime will sound.

When starting the propulsion system or whilst driving

The warning chime regarding not fastened seat belts has priority over any other warning chime.

- If seat belt is not fastened.
- If a door or the tailgate is not fully closed when starting off.
- If a certain speed is exceeded with parking brake applied.
- If approaching a vehicle ahead too rapidly.
- If a programmed speed or speed limit is exceeded.
- If a warning message appears in the Driver Information Centre.
- If the electronic key is not in the passenger compartment.
- If the parking assist detects an object.

- If an unintended lane change occurs.
- If safety function of the power tailgate detects obstacles in the moving area.

When the vehicle is parked and / or the driver's door is opened

- With exterior lights on.

Battery voltage

When the voltage of the 12 V vehicle battery is running low, a warning message will appear in the Driver Information Centre.

1. Switch off any electrical consumers which are not required for a safe drive, e.g. seat heating, heated rear window or other main consumers.
2. Charge the 12 V vehicle battery by driving continuously for a while or by using a charging device.

If the 12 V vehicle battery cannot be recharged, have the cause of the fault remedied by a workshop.

Vehicle personalisation



The vehicle's behaviour can be personalised by changing the settings in the Info Display.

Depending on vehicle equipment and country-specific regulations some of the functions described below may not be available.

Some functions are only displayed or active when the vehicle is on.

Personal settings



Touch  and then touch .

The following settings can be selected by touching the icon or the button on the touch screen:

- **Time and date**
- **Language**
- **Radio settings**
- **Vehicle settings**
- **Devices**
- **Device Remote Access**
- **Apple CarPlay**
- **Android Auto**
- **KeyPass**
- **USB Auto Launch**
- **Wi-Fi**
- **Display Settings**
- **Rear camera**
- **Return to factory settings**
- **Audible touch feedback**
- **Text scroll**
- **Software information**

In the corresponding submenus, the following settings can be changed:

Time and date

Clock ⇨ 69.

Language

Selection of the desired language.

System settings ⇨ 116.

Radio settings

Volume settings ⇨ 115.

Vehicle settings

- **Climate and air quality**

Auto fan speed: Modifies the level of the cabin airflow of the climate control in automatic mode.

Auto heated seats: Automatically activates the seat and steering wheel heating.

Auto demist: Supports windscreen dehumidification by automatically selecting the necessary settings and automatic air conditioning mode.

- **Comfort and convenience**

Chime volume: Changes the volume of warning chimes.

Personalisation by driver: Activates or deactivates the personalisation function.

Auto wipe in reverse gear:

Activates or deactivates automatic switching on of the rear window wiper when reverse gear is engaged.

- **Collision / detection systems**

Pedestrian safety signal:

Activates or deactivates pedestrian safety alert. Even if pedestrian safety signal is deactivated, it is automatically activated while this menu is not accessible such as OnStar calling, camera projection, Apple CarPlay and Android Auto, non-auto dismiss pop-up, etc.

Forward Collision System: This allows the feature's notification to be customised. This feature will turn on or off the Forward Collision Alert and Active Emergency Braking. The **Off** setting disables all Forward Collision Alert and Active Emergency Braking functions. With the **Alert and Brake** setting, both Forward Collision Alert and Active Emergency Braking are available. The **Alert** setting

disables Active Emergency Braking. Select **Off**, **Alert**, or **Alert and Brake**.

Front pedestrian detection: This allows the feature's notification to be customised. This feature may help avoid or reduce the harm caused by front-end crashes with nearby pedestrians. Select **Off**, **Alert**, or **Alert and Brake**.

Rear Cross Traffic Alert:

Activates or deactivates rear cross traffic alert.

Lane Change Alert: Activates or deactivates lane change alert.

- **Lighting**

Vehicle locator lights: Activates or deactivates the entry lighting.

Exit lighting: Activates or deactivates and changes the duration of exit lighting.

- **Power door locks**

Auto door lock: Activates or deactivates the automatic door locking function after switching on the vehicle.

Unlocked door anti lockout:

Activates or deactivates the door locking function while a door is open.

Delayed door lock: Activates or deactivates the delayed door locking function. This feature delays the actual locking of the doors until all doors are closed. It just can be toggled when **Auto door lock** is deactivated.

- **Remote lock / unlock / start**

Remote unlock light feedback:

Activates or deactivates the hazard warning flasher feedback whilst unlocking.

Remote lock feedback: Changes what kind of feedback is given when locking the vehicle.

Remote door unlock: Changes the configuration to unlock only the driver's door or the whole vehicle whilst unlocking.

Relock remotely unlocked doors:

Activates or deactivates the automatic relock function after unlocking without opening the vehicle.

Remote start auto heat seats:

Activates or deactivates automatically the heated seats when using remote start.

Passive door unlock: Changes the configuration to unlock only the driver's door or the whole vehicle whilst unlocking.

Relock remotely unlocked doors:

Activates or deactivates the passive locking function. This feature locks the vehicle automatically after several seconds if all doors have been closed and an electronic key has been removed from the vehicle.

Remote start auto heat seats:

Activates or deactivates automatically the heated seats when using remote start.

Passive door unlock: Changes the configuration to unlock only the driver's door or the whole vehicle whilst unlocking.

Passive door lock: Activates or deactivates the passive locking function. This feature locks the vehicle automatically after several seconds if all doors have

been closed and an electronic key has been removed from the vehicle.

Remote left in vehicle alert:

Activates or deactivates the warning chime when the electronic key remains in the vehicle.

Devices

External devices ⇨ 125.

Device remote access

Smartphone remote function ⇨ 27.

Apple CarPlay

Using smartphone applications
⇨ 131.

Android Auto

Using smartphone applications
⇨ 131.

KeyPass

Smartphone remote function ⇨ 27.

USB Auto Launch

External devices ⇨ 125.

Wi-Fi

System settings ⇨ 116.

Display Settings

System settings ⇨ 116.

Rear camera

Symbols: Activates or deactivates the symbols.

Guidelines: Activates or deactivates the guiding lines.

Return to factory settings

Reset vehicle settings: Resets all settings to the default settings.

Clear all private data: Deletes all private information from the vehicle.

Restore radio settings: Resets all radio settings to the default settings.

System settings ⇨ 116.

Audible touch feedback

Usage ⇨ 109.

Text scroll

System settings ⇨ 116.

Software information

System settings ⇨ 116.

Telematics service

OnStar

OnStar is a personal connectivity and service assistant with integrated Wi-Fi hotspot. The OnStar service is available 24 hours a day, seven days a week.

Note

OnStar is not available for all markets. For further information, contact your workshop.

Note

In order to be available and operational, OnStar needs a valid OnStar subscription, functioning vehicle electrics, mobile service and GPS satellite link.

To activate the OnStar services and set up an account, press  and speak with an advisor.

Depending on the equipment of the vehicle, the following services are available:

- Emergency services and support in the case of a vehicle breakdown
- Wi-Fi hotspot
- Smartphone application
- Remote control, e.g. location of the vehicle, activation of horn and lights, control of central locking system
- Stolen vehicle assistance
- Vehicle diagnostics
- Destination download

Note

The OnStar module of the vehicle is deactivated after ten days without switching on the vehicle. Functions requiring a data connection will be available again after switching on the vehicle.

OnStar buttons



Privacy button

Press and hold  until a message is heard to activate or deactivate the transmission of the vehicle location.

Press  to answer a call or to end a call to an advisor.

Press  to access the Wi-Fi settings.

Service button

Press  to establish a connection to an advisor.

SOS button

Press  to establish a priority emergency connection to a specially trained emergency advisor.

Status LED

Green: The system is ready with activated transmission of the vehicle location.

Green flashing: The system is on a call.

Red: A problem arose.

Off: The system is ready with deactivated transmission of the vehicle location or the system is in standby mode.

Red / green flashing for a short period of time: The transmission of the vehicle location has been deactivated.

OnStar services

General services

If you need any information e.g. opening hours, points of interest and destinations or if you need any support e.g. in the case of a vehicle

breakdown, a flat tyre and low vehicle battery voltage, press  to establish a connection to an advisor.

Emergency services

In the case of an emergency situation, press  and talk to an advisor. The advisor then contacts emergency or assistance service providers and directs them to your vehicle.

In the case of an accident with activation of airbags or belt tensioners, an automatic emergency call is established. The advisor is immediately connected to your vehicle to see whether help is needed.

Note

Establishing an emergency call may not be possible in areas without sufficient network availability or due to hardware damage during an accident.

Wi-Fi hotspot

The Wi-Fi hotspot of the vehicle provides internet connectivity with a maximum speed of 4G/LTE.

Note

The Wi-Fi hotspot functionality is not available for all markets.

Note

Some mobile devices connect to Wi-Fi hotspots automatically and use mobile data capacity in the background, even if they are not in use. This includes automatic updates, downloads, as well as programme or app synchronisation traffic. The data volume purchased via OnStar might be consumed rapidly. Turn off automatic synchronisations in the settings of your device.

Up to seven devices may be connected.

To connect a mobile device with the Wi-Fi hotspot:

1. Press  and then select Wi-Fi settings on the Info Display. The settings displayed include the Wi-Fi hotspot name (SSID), password and connection type.
2. Start a Wi-Fi network search on your mobile device.

3. Select your vehicle hotspot (SSID) when listed.
4. When prompted, enter the password on your mobile device.

Note

To change the SSID or password, press  and talk to an advisor or log in to your account.

To switch off the Wi-Fi hotspot functionality, press  to call an advisor.

Smartphone app

With the myOpel smartphone app, some vehicle functions can be operated remotely.

The following functions are available:

- Lock or unlock vehicle.
- Honk horn or flash lights.
- Operate parking heater.
- Check vehicle battery-related information.
- Check tyre pressure (only with tyre pressure monitoring system).

- Send navigation destination to the vehicle for use with navigation application via phone projection.
- Locate vehicle on a map.
- Manage Wi-Fi settings.

To operate these functions, download the app from App Store® or Google Play™ Store.

Remote control

If desired, use any phone to call an advisor, who can remotely operate specific vehicle functions. Find the respective OnStar phone number on our country-specific website.

The following functions are available:

- Lock or unlock vehicle.
- Provide information on the vehicle location.
- Honk horn or flash lights.

Stolen vehicle assistance

If the vehicle is stolen, report the theft to the authorities and request OnStar stolen vehicle assistance. Use any

phone to call an advisor. Find the respective OnStar phone number on our country-specific website.

OnStar can provide support in locating and recovering the vehicle.

Theft alert

When the anti-theft alarm system is triggered, a notification is sent to OnStar. You are then informed about this event by text message or email.

Restart prevention

By sending remote signals, OnStar can prevent the vehicle from restarting once it has been turned off.

On-demand diagnostics

At any time e.g. if the vehicle displays a vehicle message, press  to contact an advisor and ask to complete a real-time diagnostic check to directly determine the issue. Depending on the results, the advisor will provide further support.

Diagnostic report

The vehicle automatically transmits diagnostic data to OnStar which sends a monthly email report to you and your preferred workshop.

Note

The workshop notification function can be disabled in your account.

The report contains the status of key operating systems of the vehicle like propulsion system, airbags, ABS, and other major systems. It also provides information on possible maintenance items and tyre pressure (only with tyre pressure monitoring system).

To look at the information in greater detail, select the link within the email and log in to your account.

OnStar settings

OnStar PIN

To have full access to all OnStar services, a four-digit PIN is required. The PIN has to be personalised when first talking to an advisor.

To change the PIN, press  to call an advisor.

Account data

An OnStar subscriber has an account where all the data is stored. To request a change of the account information, press  and talk to an advisor or log in to your account.

If the OnStar service is used on another vehicle, press  and request that the account be transferred to the new vehicle.

Note

In any case, if the vehicle is disposed of, sold or otherwise transferred, immediately inform OnStar about the changes and terminate the OnStar service on this vehicle.

Vehicle location

The vehicle location is transmitted to OnStar when service is requested or triggered. A message on the Info Display informs about this transmission.

To activate or deactivate the transmission of the vehicle location, press and hold  until an audio message is heard.

The deactivation is indicated by the status light flashing red and green for a short period of time and each time the vehicle is started.

Note

If the transmission of the vehicle location is deactivated, some services are no longer available.

Note

The vehicle location always remains accessible to OnStar in the case of an emergency.

Find the privacy policy in your account.

Software updates

OnStar may remotely carry out software updates without further notice or consent. These updates are to enhance or maintain safety and security or the operation of the vehicle.

These updates may concern privacy issues. Find the privacy policy in your account.

Lighting

Exterior lighting	98
Light switch	98
Automatic light control	99
High beam	99
High beam assist	100
Headlight flash	101
Headlight range adjustment	101
Headlights when driving abroad	101
Daytime running lights	101
Hazard warning flashers	101
Turn lights	102
Rear fog light	102
Parking lights	102
Reversing lights	103
Misted light covers	103
Interior lighting	103
Instrument panel illumination control	103
Interior lights	103
Reading lights	104
Sunvisor lights	104
Lighting features	104
Entry lighting	104

Exit lighting	104
Battery discharge protection	104

Exterior lighting

Light switch



Turn light switch:



- AUTO** : automatic light control
switches automatically
between daytime running
light and headlight
- ☞☞ : sidelights
- ☞☞☞ : headlights

Control indicator ☞☞ ☞ 81.

Light switch with position



Turn light switch:

- AUTO** : automatic light control switches automatically between daytime running light and headlight
-  : activation or deactivation of the automatic light control.
-  : sidelights
-  : headlights

Tail lights

Tail lights are illuminated together with low / high beam and sidelights.

Automatic light control





When the automatic light control function is switched on and the vehicle is switched on, the system switches between daytime running lights and headlights automatically depending on the external lighting conditions.

Daytime running light  101.

Automatic headlight activation

During poor lighting conditions headlights are switched on.

Additionally, headlights, parking lights and other exterior lights are switched on if the windscreen wipers

have been activated. The transition time for the lights coming on varies based on wiper speed. When the wipers are not operating, these lights turn off. Move the exterior light control to  or  to disable this feature.

Note

Do not cover the light sensor otherwise the AUTO mode will not operate properly.

Tunnel detection

When a tunnel is entered headlights are switched on.

High beam



Push stalk to switch from low to high beam.

Pull stalk to deactivate high beam.

High beam assist



This feature automatically activates the high beam at night.

The camera in the windscreen detects the lights of oncoming or preceding vehicles. High beam can be triggered or faded out particularly according to the traffic situation. This gives the best light distribution without dazzling other road users. Once activated, high beam assist remains active and switches high beam on and off depending on surrounding conditions. The latest setting of the high beam assist will remain after the vehicle is switched on again.

Activation

Activate high beam assist by pressing  once. High beam is switched on automatically at a speed above

50 km/h. High beam is switched off at a speed below 35 km/h, but high beam assist remains active.

The green control indicator  illuminates continuously when the high beam assist is activated, the blue one  illuminates when high beam is on.

Control indicator   81,   81.

Pushing the stalk once switches on manual high beam without high beam assist.

High beam assist switches automatically back to low beam when:

- Driving in urban areas.
- Reverse parking function is active.
- Rear fog light is switched on.

If there are no restrictions detected, the system switches back to high beam.

Deactivation

If high beam assist is active and high beam is on, press  once or pull the stalk once to deactivate high beam assist.

If high beam assist is active and high beam is off, press  once to deactivate high beam assist.

Pushing the stalk to activate manual high beam will also deactivate high beam assist.

Headlight flash in conjunction with high beam assist

Headlight flash by pulling the stalk once will not deactivate high beam assist when high beam is off.

Headlight flash by pulling the stalk once deactivates high beam assist when high beam is on.

Fault in headlight system

When the system detects a failure in the headlight system, it selects a preset position to avoid dazzling of oncoming traffic. A warning is displayed in the Driver Information Centre.

Headlight flash

To activate the headlight flash, pull stalk.

Pulling stalk deactivates high beam.

Headlight range adjustment

Manual headlight range adjustment



To adapt headlight range to the vehicle load to prevent dazzling: turn thumb wheel  to required position.

0 : front seats occupied

1 : all seats occupied

- 2 : all seats occupied and load compartment laden
- 3 : driver's seat occupied and load compartment laden

Headlights when driving abroad

When driving in countries where traffic drives on the opposite side of the road, the headlights do not have to be adjusted.

Daytime running lights

Daytime running lights increase visibility of the vehicle during daylight.

While the daytime running light is active, the tail lights and the sidelights are switched off.

Please remember that the low beam should be switched on when required.

Hazard warning flashers

Operated by pressing .

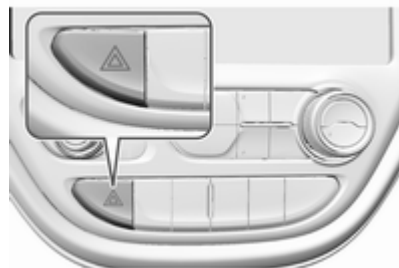

In the event of an accident with airbag deployment, the hazard warning flashers are activated automatically.

Turn lights

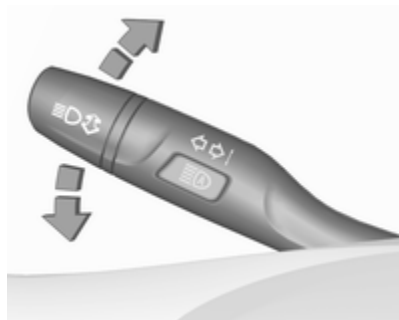

stalk up : right turn light
 stalk down : left turn light

A resistance point can be felt when moving the stalk.

Constant flashing is activated when the stalk is being moved beyond the resistance point. It is deactivated when the steering wheel is moved in the opposite direction or stalk is manually moved back to its neutral position.

Activate temporary flashing by holding the stalk just before the resistance point. Turn lights will flash until stalk is being released.

To activate three flashes, tap the stalk briefly without passing the resistance point.

Rear fog light



Operated by pressing ☼ .

The rear fog light is automatically set to off each time the vehicle is started. Headlights and sidelights must be on for the rear fog light to work.

Parking lights



When the vehicle is parked, the parking lights on one side can be activated:

1. Switch off vehicle.
2. Move stalk all the way up (right parking lights) or down (left parking lights).

Confirmed by a signal and the corresponding turn light control indicator.

The parking lights will remain illuminated until the vehicle is switched on or the stalk is returned to its original position.

Reversing lights

The reversing light comes on when the vehicle is on and reverse gear is selected.

Misted light covers

The inside of the light housing may mist up briefly in poor, wet and cold weather conditions, in heavy rain or after washing. The mist disappears quickly by itself. To help, switch on the headlights.

Interior lighting

Instrument panel illumination control



Brightness of the following lights can be adjusted when the exterior lights are on.

- instrument panel illumination
- Info Display
- illuminated switches and operation elements

Turn thumb wheel  until the desired brightness is obtained.

Interior lights

During entry and exit of the vehicle, the courtesy lights automatically switch on and then off after a delay.

Front courtesy light



To operate, press the following buttons:

 : automatic switching on and off

press  : on

press  : off

Reading lights





Operated by pressing the buttons at the front.

Sunvisor lights

Illuminates when the cover is opened.

Lighting features

Entry lighting

Low beam and the interior lights turn on briefly by pressing  on the electronic key. The lights turn off immediately when **POWER**  is pressed or automatically after a brief period.

Exit lighting

The low beam and the reversing light come on by doing the following:

1. Switch off the vehicle.
2. Open the driver's door.
3. Pull the stalk briefly and release.

Some interior lights come on when the vehicle is switched off. The exterior and the interior lights remain on after the door is closed for a brief period and then turn off.

Activation, deactivation and duration of this function can be changed in the Info Display.

Vehicle personalisation  90.

Battery discharge protection

Vehicle battery state of charge function

The vehicle battery saver feature is designed to protect the 12 V vehicle battery. If any interior light is left on and the vehicle is switched off, the vehicle battery discharge protection system automatically turns the lights off after approx. 10 minutes.

If the exterior lights are left on, they turn off when the vehicle is switched off. If the sidelights are switched on when the vehicle is switched off, the sidelights remain on until they are manually switched off.

Infotainment system

Introduction	105
General information	105
Theft-deterrent feature	106
Control elements overview	107
Usage	109
Basic operation	112
Tone settings	114
Volume settings	115
System settings	116
Radio	119
Usage	119
Station search	120
Radio data system	122
Digital audio broadcasting	123
External devices	125
General information	125
Playing audio	127
Displaying pictures	129
Playing movies	130
Using smartphone applications	131
Speech recognition	132
General information	132
Usage	132

Phone	133
General information	133
Bluetooth connection	133
Emergency call	135
Operation	136
Mobile phones and CB radio equipment	139

Introduction

General information

The Infotainment system provides you with state-of-the-art in-car Infotainment.

Using radio tuner functions, you can listen to a great number of different radio stations.

You can connect external data storage devices to the Infotainment system as further audio sources, either via cable or via Bluetooth.

The Infotainment system is equipped with a phone portal that allows for comfortable and safe use of your mobile phone in the vehicle.

You can also operate specific smartphone applications via the Infotainment system.

Optionally, the Infotainment system can be operated using the touch screen and buttons on the control panel, the controls on the steering wheel, or - if provided by your mobile phone - via speech recognition.

The well-thought-out design of the control elements, the touch screen and the clear displays enable you to control the system easily and intuitively.

Note

This manual describes all options and features available for the various Infotainment systems. Certain descriptions, including those for display and menu functions, may not apply to your vehicle due to model variant, country specifications, special equipment or accessories.

Important information on operation and traffic safety

⚠ Warning

The Infotainment system must be used so that the vehicle can be driven safely at all times. If in doubt, stop the vehicle and operate the Infotainment system while the vehicle is stationary.

Radio reception

Radio reception may be disrupted by static, noise, distortion or loss of reception due to:

- changes in distance from the transmitter
- multipath reception due to reflection
- shadowing

Theft-deterrent feature





The Infotainment system is equipped with an electronic security system for the purpose of theft deterrence.

The Infotainment system therefore functions only in your vehicle and is worthless to a thief.

Control elements overview

Control panel





- 1 Display / touch screen 112
- 2  (knob)
Turn: adjust volume 109
- 3  (button)
Short press: mute system ... 109
or deactivate mute
function if mute function is
active 109
or exit low power mode if
low power mode is active 109
Long press: turn on low
power mode 109
- 4 
Press: display the
Infotainment home screen . . 112
- 5 
Short press: skip to
previous or next station
when radio active 120
or skip to previous or next
track when external
devices active 127

Long press: seek up or
down when radio active 120

or fast forward or fast
rewind when external
devices active 127

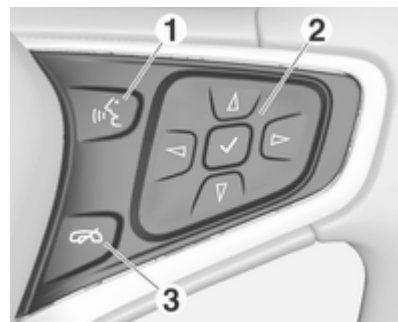
Steering wheel controls





- 1 
Short press: open OnStar
menu if no phone
connected 109
or open the phone menu 136
or take phone call if phone
connected 136
Long press: activate
speech recognition 132

2 Five-way controller
 Press buttons: operate menus on the Driver Information Centre 82

3 
 Press: end / decline call 136
 or deactivate speech recognition 132
 or activate / deactivate mute function 109



Press **FAV**  or **FAV**  to display the favourites list and choose one of the favourites stored.

Press the buttons behind the steering wheel on the right side to adjust the volume.

Usage

Control elements

The Infotainment system can be operated in different ways.

Inputs are made optionally via:

- the central control unit in the control panel ⇨ 107
- the touch screen ⇨ 112
- audio controls on the steering wheel ⇨ 107
- the speech recognition ⇨ 132

Switching the Infotainment system on or off

The Infotainment system is switched on automatically when the vehicle is turned on. After switching on, the last selected Infotainment source becomes active.

Automatic switch-off

If the Infotainment system has been switched on by pressing  while the vehicle is switched off, it will switch off again automatically 10 minutes after the last user input.

Low power mode

To save high voltage battery power, a low power mode is available.

If desired, you may turn the display off while the sound remains active.

Press and hold . A low power message is displayed. Confirm the message to turn off the display.

To cancel low power mode, press .

If the high voltage battery level of the vehicle drops below the level set in the vehicle settings menu, the Infotainment system suggests to turn off display and sound.

Note

For a detailed description of how to set the high voltage battery level  85.

A low power message is displayed. Confirm the message to turn off display and sound.

To cancel low power mode, press .

Setting the volume

Turn . The current setting is shown on the display.

When the Infotainment system is switched on, the last selected volume is set, provided that it is lower than the maximum start-up volume. For a detailed description  115.

Speed compensated volume

When the speed compensated volume is activated  115, the volume is adapted automatically to make up for the road and wind noise as you drive.

Mute

Press  to mute the Infotainment system.

To cancel the mute function: press  again. The last selected volume is set again.

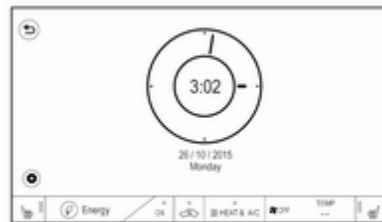

Full screen clock display

From any screen, touch the time indication field to display a clock in full screen mode.



Touch  to return to the previous screen.

Modes of operation

Press  and then select  in the top left corner of the screen to display the application overview screen.



Audio

Select **Audio** to open the main menu of the last selected audio mode.

Select **Source** on the screen to display the source list.

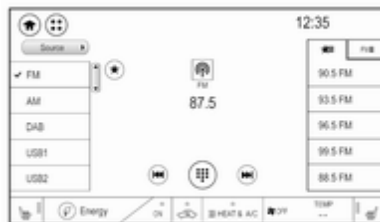



To change to another audio mode: touch one of the items in the list.

For a detailed description of:

- Radio functions ⇨ 119
- External devices (**USB, Bluetooth, iPod, AUX**) ⇨ 127

Gallery

Select **Gallery** to open the picture and movie menu for files stored on a USB device.

Select  or  to display the picture or movie menu. Select the desired picture or movie file to show the respective item on the display.

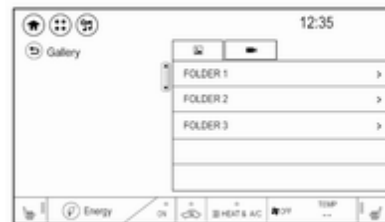

For a detailed description of:

- Picture functions ⇨ 129
- Movie functions ⇨ 130

Phone

Before the phone portal can be used, a connection has to be established between the Infotainment system and the mobile phone.

For a detailed description of preparing and establishing a Bluetooth connection between the Infotainment system and a mobile phone ⇨ 133.

If the mobile phone is connected, select **Phone** to display the main menu of the phone portal.

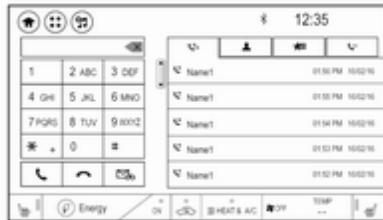

For a detailed description of mobile phone operation via the Infotainment system ⇨ 136.

Projection

To show specific apps of your smartphone display on the Infotainment system, connect your smartphone.

Select **Projection** to start the projection function.

Depending on the smartphone connected, a main menu with different selectable apps is displayed. For a detailed description ⇨ 131.

Settings

Select **Settings** to open a menu for various system related settings, e.g. deactivating **Audible touch feedback**.



OnStar

To display the OnStar menu, select **OnStar**.

For a detailed description ⇨ 93.

Basic operation

The display of the Infotainment system has a touch-sensitive surface that allows direct interaction with the displayed menu controls.

Caution

Do not use pointed or hard items like ballpoint pens, pencils or similar for touch screen operation.

⊕ screen button

Select ⊕ in the top left corner of the screen or press ⊕ on the faceplate to display the Infotainment home screen.

⊖ screen button

Select ⊖ to display the application overview screen.

⊙ screen button

When operating the menus, select ⊙ in the respective submenu to return to the next higher menu level.



Selecting a screen button or menu item

Touch a screen button or menu item. The corresponding system function is activated, a message is shown, or a submenu with further options is displayed.

Activating a function

Touch the desired menu item. Depending on the prior setting, the screen button next to the menu item changes to activation or deactivation mode.

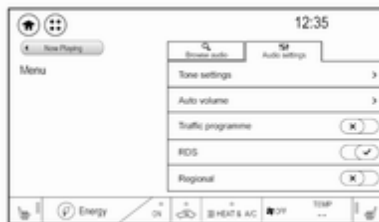

Scrolling lists

If there are more items available than presentable on the screen, the list can be scrolled.



To scroll through a list of menu items, you may optionally:

- Place your finger anywhere on the list and move it upwards or downwards.

Note

Constant pressure must be applied and the finger must be moved at constant speed.

- Move the slider of the scroll bar on the left side of the list up and down with your finger.

Editing the Infotainment home screen

Press **⌘** to display the Infotainment home screen and then select **Edit**. A screen with different possible home screen layouts is displayed.

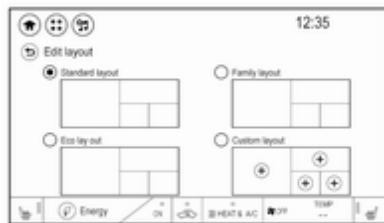

Select the desired layout. The layout is changed.

If you select **Custom layout**, a screen for custom layout settings is displayed.

Touch the different screen areas and design the layout as desired.

Quick-jumping to the Audio or Phone menu

Using the ☺ symbol displayed in the top line of some menus, you may directly jump to the main menu of the active audio source.



When a phone call is active and the phone screen is not displayed, a quick-jump phone icon is displayed to directly jump to the phone main menu.

Tone settings

In the tone settings menu, the tone characteristics can be set. The menu may be accessed from each audio main menu.

To open the tone settings menu, select **Menu** and then activate the **Audio settings** tab. Select **Tone settings** to display the respective menu.

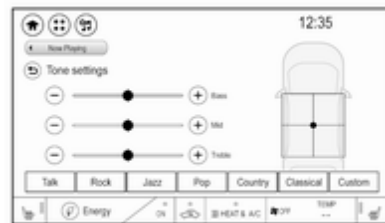

Bass

Use this setting to enhance or attenuate the deep frequencies of the audio sources.

Touch + or - to adjust the setting.

Mid

Use this setting to enhance or attenuate the midrange frequencies of the audio source.

Touch + or - to adjust the setting.

Treble

Use this setting to enhance or attenuate the high frequencies of the audio sources.

Touch + or - to adjust the setting.

Balance and fader

Use the illustration at the right side of the menu to adjust balance and fader.

To define the point in the passenger compartment where the sound is at its highest level, touch the corresponding point in the illustration.

Equaliser mode

Use this setting to optimise the tone for the style of music, e.g. **Rock** or **Classical**.

Activate the desired sound style. If you choose **Custom**, you can manually adjust the tone settings.



BOSE premium audio

If the system is equipped with BOSE premium audio, only two equaliser settings are available.

Activate **Talk** if you want the tone settings to be adjusted automatically. Activate **Custom** if you want to adjust the tone settings manually.

Volume settings

Maximum startup volume



Press  and then select  in the top left corner of the screen to display the application overview screen.

Select **Settings**, **Radio settings** and then **Maximum start-up volume**.

Touch + or - to adjust the setting.

Speed compensated volume

The volume can be automatically adjusted according to the speed noise level of the vehicle.

Press  and then select  in the top left corner of the screen to display the application overview screen.

Select **Audio** and then activate the desired audio source. Select **Menu** and activate the **Audio settings** tab. Select **Auto volume** to display the respective submenu.



To adjust the degree of volume adaptation, select one of the options in the list.

Off: no enhancement of volume with increasing vehicle speed.

High: maximum enhancement of volume with increasing vehicle speed.

Audible touch feedback function

If the audible touch feedback function is activated, each touch of a screen button or menu item is indicated by a beeping sound.

Press  and then select  in the top left corner of the screen to display the application overview screen.

Select **Settings** and then scroll through the list to **Audible touch feedback**.



Touch the screen button next to **Audible touch feedback** to activate or deactivate the function.

Audio Cues

Audio cues are short sound effects indicating certain system actions.

Configuration

Press \uparrow and then select \odot in the top left corner of the screen to display the application overview screen.

Select **Settings** and then **Radio settings**. Activate or deactivate **Audio Cues**.

Audio Cues Volume

Press \uparrow and then select \odot in the top left corner of the screen to display the application overview screen.

Select **Settings** and then **Radio settings**. Select **Audio Cues Volume** to display the respective submenu.

Adjust the volume as desired.

Note

The **Audio Cues Volume** setting is only available if **Audio Cues** is activated.

Volume of traffic announcements

To adjust the volume of traffic announcements, set the desired volume while a traffic announcement is given out by the system. The respective setting is then stored by the system.

System settings

The following settings concern the whole system. All other settings are described by theme in the respective chapters of this manual.

Time and date settings

Press \uparrow and then select \odot in the top left corner of the screen to display the application overview screen.

Select **Settings** and then **Time and date** to display the respective submenu.



Auto set

To choose whether time and date are to be set automatically or manually, select **Auto set**.

For time and date to be set automatically, select **On - RDS**.

For time and date to be set manually, select **Off - Manual**. If **Auto set** is set to **Off - Manual**, the submenu items **Set time** and **Set date** are available.

Set time

To adjust the time and date settings, select **Set time**.

Select the time format at the left side of the screen. Activate **12 hr** or **24 hr**.

Touch **+** or **-** to adjust the time settings.

Set date

To adjust the time and date settings, select **Set date**.

Touch **+** or **-** to adjust the date settings.

Language settings

Press **⏏** and then select **☺** in the top left corner of the screen to display the application overview screen.

Select **Settings** and then **Language** to display the respective menu.

To adjust the language for the menu texts: touch the desired language.

Text scroll function

If long text is displayed on the screen e.g. song titles or station names, the text may either be scrolled continually or it may be scrolled once and then displayed in truncated form.

Press **⏏** and then select **☺** in the top left corner of the screen to display the application overview screen.

Select **Settings**.



If you wish the text to be scrolled continually, activate **Text scroll**.

If you wish the text to be scrolled in blocks, deactivate the setting.

Display Settings

There are different display options available.

Press **⏏** and then select **☺** in the top left corner of the screen to display the application overview screen.

Select **Settings**. Scroll through the list and select **Display Settings**.



Select the desired option.

Wi-Fi settings

Using the **Wi-Fi** menu, you can establish a connection to an available Wi-Fi network.

Press **⌘** and then select **☺** in the top left corner of the screen to display the application overview screen.

Select **Settings** and then **Wi-Fi** to display the respective submenu.



Configuration of Wi-Fi

Activate or deactivate **Wi-Fi**.

Note

A Wi-Fi connection can only be established if **Wi-Fi** is activated.

Wi-Fi networks

To display a list of available Wi-Fi networks, select **Manage Wi-Fi Networks**.

To register a new network, select **Add Another Network**. Follow the instructions on the screen and enter the network name, security type and password. The new network appears in the list.

To reload the existing list, select **Refresh**.

To display more information on a network, select **i**.

To delete a network from the list, select **Delete**.

Factory defaults

Press **⌘** and then select **☺** in the top left corner of the screen to display the application overview screen.

Select **Settings**. Scroll through the list and select **Return to factory settings**.

To restore all vehicle personalisation settings, select **Reset vehicle settings**.

To delete the paired Bluetooth devices and all related data, select **Clear all private data**.

To reset tone and volume settings, delete all favourites, and erase the ringtone selection, select **Restore radio settings**.

In each case, a warning message is displayed. Select **Continue** to reset the settings.

System version

Open source information

Press **⌘** and then select **☺** in the top left corner of the screen to display the application overview screen.

Select **Settings**. Scroll through the list and select **Software information**.

To display open source software licensing information, select **Open source**.

Software updates

Press **⌘** and then select **☺** in the top left corner of the screen to display the application overview screen.

Select **Settings**. Scroll through the list and select **Software information**.

To start a software update, select **Software Update**. For a detailed description on software updates ⇨ 257.

To display a menu with further settings, select **Update Preferences**.

If **Download New Updates in Background** is activated, software updates are downloaded automatically by the system without specific notification. If **Download New Updates in Background** is deactivated, a message might be displayed before an update is carried out. Activate or deactivate the function as desired.



Vehicle settings

Vehicle personalisation ⇨ 90.

Radio

Usage

Activation of the radio function

Press  and then select  in the top left corner of the screen to display the application overview screen.

Select **Audio**. The audio main menu last selected is displayed.

Select **Source**.

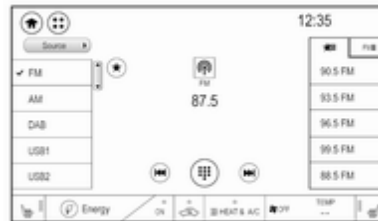

Select the desired waveband.

The station last played in the selected waveband will be received.

Audio menu

Select **Menu** to display the audio menu.

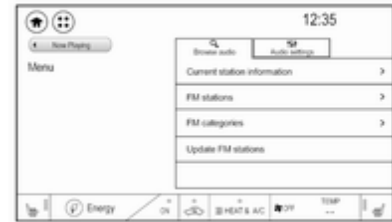

To return from the audio menu to the audio main screen, select **Now playing**.

Current station information

From the FM or DAB main screen, select **Menu** and then activate the **Browse audio** tab.

To display additional information on the station currently playing, select **Current station information**.

Station search

Automatic station search

Briefly press or touch ◀◀ or ▶▶ on the control panel or on the screen to play the previous or next station available.

Manual station search

Press and hold ◀◀ or ▶▶ on the control panel. Release when the required frequency has almost been reached.

A search is made for the next station that can be received and it is played automatically.

Note

FM waveband: when the RDS function is activated, only RDS stations ↻ 122 are searched for, and when the radio traffic service (TP) is activated, only traffic service stations ↻ 122 are searched for.

Station tuning

Touch ⊕ on the screen. The tuning display is shown.



Enter the desired frequency.

Use ✕ to delete digits entered.

Select X to delete the whole input. If necessary, touch ◀ or ▶ to subsequently adjust the input.

Note

A "." between the digits is automatically added by the system at the right location.

Stations lists

Stations

Select **Menu** to open the corresponding waveband-specific submenu.

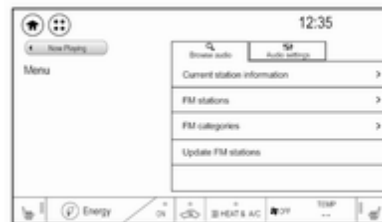

Select the **Browse audio** tab and then select the respective station list, e.g. **FM stations**. All receivable stations of the relevant waveband and in the current reception area are displayed.

Alternatively, select the waveband symbol tab, e.g. FM≡ to directly display the stations.

Select the desired station.

Categories

Numerous radio stations broadcast a PTY code, which specifies the type of programme transmitted (e.g. news). Some stations also change the PTY code depending on the content which is currently transmitted.

The Infotainment system stores these stations, sorted by programme type in the corresponding category list.

Note

The categories list item is only available for the FM and the DAB wavebands.

To search for a programme type determined by the stations, select **Menu** and then select the **Browse audio** tab. Select **FM categories** or **DAB categories**.

A list of programme types currently available is displayed.

Select the desired programme type. A list of stations is displayed transmitting a programme of the selected type.

Select the desired station.

Update station lists

If the stations stored in the waveband-specific station list are no longer received, the station lists must be updated.

Select **Menu** and then select the **Browse audio** tab. Depending on the waveband, select **Update FM stations**, **Update DAB stations** or **Update AM stations**.

Note

If a waveband-specific station list is updated, the corresponding category list is also updated.

A station search is started and a corresponding message is displayed. Once the search is finished, the respective station list is displayed.

Favourites

Favourites of all audio sources can be stored manually in the favourites list. The favourites list contains up to 15 favourites.

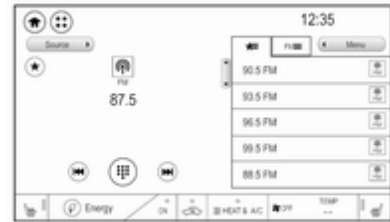



Storing a station

Activate the desired waveband and station.

Activate the **★** icon to display the favourites list. Touch and hold the desired list item for a few seconds. The currently active frequency or station is stored to the list item.

Alternatively, select **⊕** on the screen or in a list. The favourite is saved and the screen button changes to **⊕**.

To delete a station, fling the respective list item to the right. The favourite is wiped from the favourites list.

Alternatively, touch . The favourite is deleted from the list and the screen button changes to .

Retrieving stations

Activate the  tab to display the favourites list.

Select the preset screen button on which the desired radio station is stored.

Radio data system

Radio data system (RDS) is a service of FM stations that considerably facilitates the finding of the desired station and its fault-free reception.

Advantages of RDS

- On the display, the programme name of the station appears instead of its frequency.
- During a station search, the Infotainment system tunes in to RDS stations only.

- The Infotainment system always tunes into the best receivable broadcasting frequency of the set station by means of AF (alternative frequency).
- Depending on the station that is received, the Infotainment system displays radio text that can contain e.g. information on the current programme.

RDS configuration

To use the RDS functions, **RDS** has to be activated.

Activate the FM waveband. Select **Menu** to open the corresponding waveband-specific submenu and then select the **Audio settings** tab.

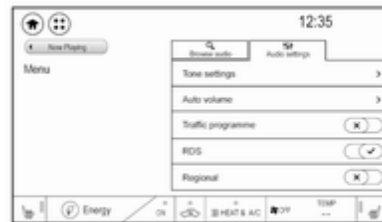

Activate or deactivate **RDS**.

Traffic programme

Radio traffic service stations are RDS stations that broadcast traffic news. If the traffic service is switched on, the current audio source is interrupted for the duration of the traffic announcement.

Activate the FM waveband. Select **Menu** to open the corresponding waveband-specific submenu.

Touch the screen button next to **Traffic programme** to activate or deactivate the function.

If a traffic announcement is broadcasted on the respective station, a message is displayed.

To interrupt the announcement and return to the function previously activated, touch the screen or press \odot .

Regionalisation

Sometimes RDS stations broadcast regionally different programmes on different frequencies.

If regionalisation is activated, alternative frequencies with the same regional programmes are selected where necessary. If regionalisation is switched off, alternative frequencies of the stations are selected without regard to regional programmes.

Activate the FM waveband. Select **Menu** to open the corresponding waveband-specific submenu and then select the **Audio settings** tab.

Activate or deactivate **Regional**.

Digital audio broadcasting

Digital audio broadcasting (DAB) broadcasts radio stations digitally.

DAB stations are indicated by the programme name instead of the broadcasting frequency.

General information

- With DAB, several radio programmes (services) can be broadcast on a single ensemble.
- Besides high-quality digital audio services, DAB is also able to transmit programme-associated data and a multitude of other data services including travel and traffic information.
- As long as a given DAB receiver can pick up the signal sent out by a broadcasting station (even if the signal is very weak), sound reproduction is ensured.
- In the event of poor reception, the volume is reduced automatically to avoid the output of disagreeable noises.

If the DAB signal is too weak to be picked up by the receiver, reception is interrupted completely. This incident can be avoided by activating **DAB to DAB linking** and / or **DAB to FM**

linking in the DAB menu (see below).

- Interference caused by stations that are on nearby frequencies (a phenomenon that is typical of AM and FM reception) does not occur with DAB.
- If the DAB signal is reflected by natural obstacles or buildings, the reception quality of DAB is improved, whereas AM or FM reception is considerably impaired in such cases.
- When DAB reception is enabled, the FM tuner of the Infotainment system remains active in the background and continually searches for the FM stations with the best reception. If TP \odot 122 is activated, traffic announcements of the FM station with the best reception are issued. Deactivate TP if DAB reception should not be interrupted by FM traffic announcements.

DAB announcements

Besides their music programmes, a lot of DAB stations also broadcast announcements of various categories. If you activate some or all categories, the currently received DAB service is interrupted when an announcement of these categories is made.

Activate the DAB waveband. Select **Menu** to open the corresponding waveband-specific submenu and then select the **Audio settings** tab.

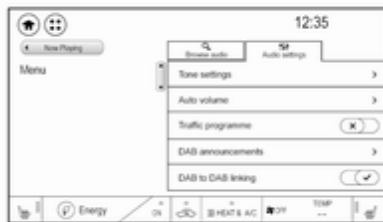

Select **DAB announcements** to display a list of the categories available.

Activate all or just the desired announcement categories. Different announcement categories can be selected at the same time.

DAB to DAB linking

If this function is activated, the device switches over to the same service (programme) on another DAB ensemble (if available) when the DAB signal is too weak to be picked up by the receiver.

Select **Menu** to open the corresponding waveband-specific submenu and then select the **Audio settings** tab.

Activate or deactivate **DAB to DAB linking**.

DAB to FM linking

If this function is activated, the device switches over to a corresponding FM station of the active DAB service (if available) when the DAB signal is too weak to be picked up by the receiver.

Select **Menu** to open the corresponding waveband-specific submenu and then select the **Audio settings** tab.

Activate or deactivate **DAB to FM linking**.

L band

With this function, you may define which DAB wavebands are received by the Infotainment system.

L band (earth and satellite radio) is an additional radio band that can be received.

Select **Menu** to open the corresponding waveband-specific submenu and then select the **Audio settings** tab.

Activate or deactivate **L band**.

External devices

General information



An AUX and USB port for the connection of external devices is located in the centre console.

Note

The port must always be kept clean and dry.

AUX input

It is possible to connect e.g. an iPod or another auxiliary device with a 3.5 mm jack plug to the AUX input.

When connected to the AUX input, the audio signal of the auxiliary device is transmitted via the speakers of the Infotainment system.

The volume and the tone settings can be adjusted via the Infotainment system. All other control functions must be operated via the auxiliary device.

Connecting a device

Connect the AUX device to the AUX port.

Disconnecting a device

Disconnect the AUX device from the AUX port.

USB port

An MP3 player, USB drive, SD card (via USB connector / adapter), iPod® or smartphone can be connected to the USB port.

Up to two USB devices can be connected to the Infotainment system at a time.

The Infotainment system can play audio files, show picture files or play movie files contained in USB storage devices.

When connected to the USB port, various functions of the devices can be operated via the controls and menus of the Infotainment system.

Note

Not all auxiliary devices are supported by the Infotainment system. Check the compatibility list on our website.

Connecting a device

Connect one of the devices mentioned above to the USB port. If required, use the appropriate connection cable. The music function starts automatically.

Note

If a non-readable USB device is connected, a corresponding error message appears and the Infotainment system automatically switches to the previous function.

Disconnecting a device

To disconnect the USB device, select another function and then remove the USB storage device.



Caution

Avoid disconnecting the device during playback. This may damage the device or the Infotainment system.

USB Auto Launch

By default, the USB audio menu is displayed automatically as soon as a USB device is connected.

If desired, this function can be deactivated.

Press  and then select  in the top left corner of the screen to display the application overview screen.

Select **Settings**. Scroll to **USB Auto Launch** and touch the screen button next to the function.

To reactivate the function, touch the screen button again.

Bluetooth

Devices which support the Bluetooth music profiles A2DP and AVRCP can be connected wirelessly to the Infotainment system. The Infotainment system can play music files contained in these devices.

When connected to the USB port, various functions of the devices can be operated via the controls and menus of the Infotainment system.

Connecting and disconnecting a device

For a detailed description on how to establish a Bluetooth connection ⇨ 133.

Manage Bluetooth devices

In the Bluetooth music menu, select **Menu** to display the Bluetooth audio menu and then select the **Audio settings** tab. Select **Manage Bluetooth devices**. The **Devices** list is displayed.

For a detailed description ⇨ 133.

File formats and folders

The maximum capacity of a device supported by the Infotainment system amounts to 5000 music files and 15 stages of folder structure. Only devices formatted in the FAT16 / FAT32 file system are supported.

If there are images included in the audio metadata, these images are displayed on the screen.

Note

Some files may not be played properly. This may be due to a different recording format or the condition of the file.

Files from online shops to which Digital Rights Management (DRM) has been applied cannot be played.

The Infotainment system can play the following audio, picture and movie files stored on external devices.

Audio files

The playable audio file formats are MP3 (MPEG-1 Layer 3, MPEG-2 Layer 3), WMA, AAC, AAC+, OGG,

WAF (PCM), AIFF, 3GPP (audio only) and Audio Books (MP3, WMA, AAC, AA).

The playlist formats recognised by the system are ASX, M3U, PLS, WPL, B4S and XSPF.

Picture files

The displayable picture file formats are JPG, BMP, PNG and GIF.

Movie files

The playable movie file formats are AVI and MP4.

The maximum resolution is 1280 x 720 pixels. The frame rate must be less than 30 fps.

The usable codec is H.264 / MPEG-4 AVC.

The playable audio formats are MP3, AC3, AAC and WMA.

Playing audio

Activating the music function



If the device is not yet connected to the Infotainment system, connect the device ↻ 125.

The respective audio main menu is displayed automatically and playback is started.

Note

If you want a USB device to directly start playback after connection, make sure that **USB Auto Launch** is activated in the **Settings** menu.

If playback is not started automatically take the following steps:

Press  and then select  in the top left corner of the screen to display the application overview screen.

Select **Audio** to open the audio main menu last selected.

Select **Source** and then activate the desired media source to open the respective audio main menu.

Playback of an audio track starts.



The following functions can be used to operate the media source. Depending on the device, some functions may not be available.

Function buttons

Interrupting and resuming playback

Touch  to interrupt playback. The screen button changes to .

Touch  to resume playback.

Playing the next or previous track

Touch  to play the next track.

Touch  within the first seconds of the track playing to return to the previous track.

Returning to the beginning of the current track

Touch **⏮** after a few seconds of the track playing.

Fast forwarding and rewinding

Touch and hold **⏮** or **⏭**. Release to return to normal playback mode.

Playing tracks randomly

Touch **⌘** to play the tracks in random order. The screen button changes to **⌘**.

Touch **⌘** again to deactivate the shuffle function and go back to the normal playback mode.

Playing tracks repeatedly

Touch **↺** and then select one of the options in the drop-down menu.

Repeat all: All available files are played repeatedly.

Repeat song: The song currently playing is played repeatedly.

Repeat off: The repeat function is deactivated.

Browse audio function

Select **Menu** to display the respective audio menu and then select the **Browse audio** tab.



Different categories, in which the songs are sorted, are displayed, e.g. **Playlists**, **Artists** or **Albums**.

Select the desired category and subcategory (if available). The selected files are added to the playlist.

Select the track to start playback.

To return from the audio menu to the audio main screen, select **Now playing**.

Songs list

The songs list contains songs stored on the active media source.

Depending on prior selections, songs of an album or playlist are displayed. If no selection has been made, all songs are displayed in alphabetical order.

Activate the **🎵** tab to display the songs list. Select the desired song.

Favourites

Favourites of all audio sources can be stored manually in the favourites list. The favourites list contains up to 15 favourites.



Storing a song

Activate the desired media source and song.

Activate the **★** tab to display the favourites list. Touch and hold the desired list item for a few seconds. The currently playing song is stored to the list item.

Alternatively, select **⊕** on the screen or in a list. The favourite is saved and the screen button changes to **⊕**.

To delete a song, fling the respective list item to the right. The favourite is wiped from the favourites list.

Alternatively, touch . The favourite is deleted from the list and the screen button changes to .

Retrieving songs

Activate the  tab to display the favourites list.

Select the preset screen button on which the desired song is stored.

Audio settings

Activate the desired audio source and then select **Menu**.

Select the **Audio settings** tab. Adjust the settings as desired.

To return from the audio menu to the audio main screen, select **Now playing**.

Displaying pictures



You can view pictures from a USB device connected to the USB port.

Note

For your safety, some features are disabled while driving.

Activating the picture function

If the device is not yet connected to the Infotainment system, connect the device  125.

Press  and then select  in the top left corner of the screen to display the application overview screen.

Select **Gallery** to open the media main menu.

Select  to open the picture main menu to display a list of items stored on the USB device. Select the desired picture. If this is stored within a folder, select the respective folder first.



Touch the screen to hide the menu bar. Touch the screen again to redisplay the menu bar.

Function buttons

Viewing the next or previous picture

Touch  to view the next picture.

Touch  to view the previous picture.

Rotating a picture

Select  to rotate the picture.

Zoom in on a picture

Touch  to zoom in on a picture or to return to its original size.

Viewing a slide show

Select  to view the pictures stored on the USB device in a slide show.

Touch the screen to end the slide show.

Picture menu

Select **Menu** to display the **Picture menu**.



Slide show time

Select **Slide show time** to display a list of possible time sequences. Activate the desired time sequence in which one picture is to be displayed in a slide show.

Clock and temperature display

To display time and temperature in full screen mode, activate **Clock / temp display**.

Display settings

Select **Display Settings** to open a submenu for the adjustment of brightness and contrast.

Touch + or - to adjust the settings.

Playing movies



You can view movies from a USB device connected to the USB port.

Note

For your safety, the movie function is not available while driving.

Activating the movie function

If the device is not yet connected to the Infotainment system, connect the device ↗ 125.

Press  and then select  in the top left corner of the screen to display the application overview screen.

Select **Gallery** to open the media main menu.

Select  to open the movie main menu to display a list of items stored on the USB device. Select the desired movie. If this is stored within a folder, select the respective folder first.

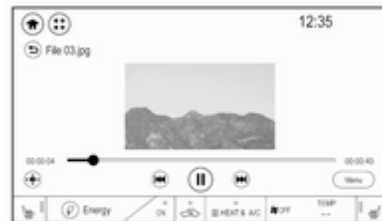

The movie is shown.



Touch the screen to hide the menu bar. Touch the screen again to redisplay the menu bar.

Function buttons

Full screen

Select  to display the movie in full screen mode. Touch  again to exit full screen mode.

Interrupting and resuming playback

Touch **II** to interrupt playback. The screen button changes to **▶**.

Touch **▶** to resume playback.

Playing the next or previous track

Touch **▶▶** to play the next movie file.

Touch **◀◀** within the first seconds of the movie playing to return to the previous movie file.

Returning to the beginning of the current movie

Touch **◀◀** after a few seconds of the movie playing.

Fast forwarding and rewinding

Touch and hold **◀◀** or **▶▶**. Release to return to normal playback mode.

Movie menu

Select **Menu** to display the movie menu.



Clock and temperature display

To display time and temperature in full screen mode, activate **Clock / temp display**.

Display settings

Select **Display Settings** to open a submenu for adjustment of brightness and contrast.

Touch + or - to adjust the settings.

Using smartphone applications

The phone projection applications Apple CarPlay™ and Android™ Auto display selected apps from your

smartphone on the Info Display and allow their operation directly via the Infotainment controls.

Check with the device's manufacturer if this function is compatible with your smartphone and if this application is available in the country you are in.

Preparing the smartphone

Android phone: Download the Android Auto app to your smartphone from the Google Play™ Store.

iPhone: Make sure Siri® is activated on your smartphone.

Activating phone projection in the settings menu

Press **⏏** and then select **☺** in the top left corner of the screen to display the application overview screen.

Select **Settings**.

Scroll through the list to **Apple CarPlay** or **Android Auto**.

Make sure the respective application is activated.

Connecting the mobile phone

Connect the smartphone to the USB port ↗ 125.

When first connecting a device, a privacy consent message may be displayed. Confirm the message to continue the connection procedure.

Starting phone projection

Press ↗ and then select ☺ in the top left corner of the screen to display the application overview screen.

To start the phone projection function, select **Projection**.

Note

If the application is recognised by the Infotainment system, the application icon may change to **Apple CarPlay** or **Android Auto**.

Alternatively, press and hold ↗.

The phone projection screen displayed depends on your smartphone and software version.

Returning to the home screen

Press ↗.

Speech recognition

General information

The voice pass-thru application of the Infotainment system allows access to the speech recognition commands on your smartphone. See your smartphone manufacturer's operating instructions to find out whether your smartphone supports this feature.

In order to use the voice pass-thru application, the smartphone must be connected to the Infotainment system via USB cable ↗ 125 or via Bluetooth ↗ 133.

Usage

Activating speech recognition

Press and hold 🗨️ on the steering wheel to start a speech recognition session. A voice command message is displayed on the screen.

As soon as a beep is heard, you can say a command. For information on the commands supported, see the operating instructions for your smartphone.

Adjusting the volume of voice prompts

Turn 🔊 on the control panel or press the volume buttons behind the steering wheel to increase or decrease the volume of voice prompts.

Deactivating speech recognition

Press 🚫 on the steering wheel. The voice command message disappears and the speech recognition session is ended.

Phone

General information

The phone portal provides you with the possibility of having mobile phone conversations via a vehicle microphone and the vehicle loudspeakers as well as operating the most important mobile phone functions via the Infotainment system in the vehicle. To be able to use the phone portal, the mobile phone must be connected to the Infotainment system via Bluetooth.

Not all phone functions are supported by every mobile phone. The usable phone functions depend on the relevant mobile phone and network provider. You can find further information on this in the operating instructions for your mobile phone, or you can enquire about them with your network provider.

Important information for operation and traffic safety

Warning

Mobile phones have effects on your environment. For this reason safety regulations and directions have been prepared. You should be familiar with the related directions before you use the telephone function.

Warning

Use of the hands-free facility while driving can be dangerous because your concentration is reduced when telephoning. Park your vehicle before you use the hands-free facility. Follow the stipulations of the country in which you find yourself at present.

Do not forget to follow the special regulations that apply in specific areas and always switch off the mobile phone if the use of mobile phones is prohibited, if

interference is caused by the mobile phone or if dangerous situations can occur.

Bluetooth

The phone portal is certified by the Bluetooth Special Interest Group (SIG).

You can find further information about the specification on the internet at <http://www.bluetooth.com>

Bluetooth connection

Bluetooth is a radio standard for the wireless connection of e.g. mobile phones, smartphones or other devices.



The pairing and connecting of the Bluetooth devices to the Infotainment system are carried out via the **Devices** menu. Pairing is the PIN code exchange between the Bluetooth device and the Infotainment system.

Pairing a device

Important information

- Up to ten devices can be paired to the system.
- Only one paired device can be connected to the Infotainment system at a time.
- Pairing only needs to be carried out once, unless the device is deleted from the list of paired devices. If the device has been connected previously, the Infotainment system establishes the connection automatically.
- Bluetooth operation considerably drains the device's battery. Therefore, connect the device to the USB port for charging.

Pairing a new device



1. Activate the Bluetooth function of the Bluetooth device. For further information, see the operating instructions for the Bluetooth device.
2. Press  and then select  in the top left corner of the screen to

display the application overview screen.

Select **Phone** on the display of the Infotainment system. The **Devices** menu is displayed.



Note

The **Devices** menu can also be accessed via the settings menu: Press  and then select  in the top left corner of the screen to display the application overview screen. Select **Settings**. Scroll through the list and select **Devices**.

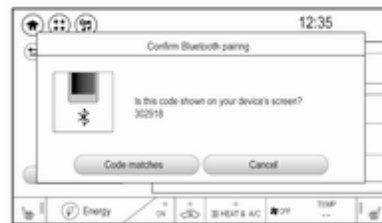

3. Touch **Add device**. All discoverable Bluetooth devices in the environment are displayed in a new search list.

4. Select the device name of the Bluetooth device you wish to pair.
5. Confirm the messages on the Bluetooth device and the Infotainment system.



6. The Infotainment system and the device are paired.

Note



If the Bluetooth device is successfully paired,  next to the Bluetooth device indicates that the phone function is enabled and  indicates that the Bluetooth music function is enabled.

7. The phone book is downloaded automatically to the Infotainment

system. Depending on the phone, the Infotainment system must be allowed access to the phone book. If required, confirm the messages displayed on the Bluetooth device.

If this function is not supported by the Bluetooth device, a corresponding message is displayed.



Connecting a paired device

Press  and then select  in the top left corner of the screen to display the application overview screen.

Select **Settings**. Select **Bluetooth Phone** and then **Devices** to display the respective menu.

Select the Bluetooth device you wish to connect. The device is connected.

Disconnecting a device



Press  and then select  in the top left corner of the screen to display the application overview screen.

Select **Settings**. Scroll through the list and select **Devices** to display the respective menu.

Select the Bluetooth device currently connected. You are prompted with a message.

Confirm the message to disconnect the device.

Deleting a device

Press  and then select  in the top left corner of the screen to display the application overview screen.



Select **Settings**. Scroll through the list and select **Devices** to display the respective menu.

Select **Delete** next to the Bluetooth device you want to delete. You are prompted with a message.

Confirm the message to delete the device.

Resynchronising contacts

The contacts list can be reloaded via the **Settings** menu.

Press  and then select  in the top left corner of the screen to display the application overview screen.

Select **Settings**. Select **Bluetooth Phone** and then select **Resync Device Contacts**. The contacts list is resynchronised.

Emergency call

Warning

Connection setup cannot be guaranteed in all situations. For this reason you should not rely exclusively on a mobile phone when a vitally important communication (e.g. a medical emergency) is concerned.

In some networks it may be necessary for a valid SIM card to be properly inserted in the mobile phone.

Warning

Bear in mind that you can make and receive calls with the mobile phone if it is in a service area with a sufficiently strong signal. Under

certain circumstances, emergency calls cannot be made in all mobile phone networks. Problems may occur when certain network services and / or telephone functions are active. You can enquire about this with the local network operators.

The emergency call number can differ depending on the region and country. Please enquire beforehand about the correct emergency call number for the relevant region.

Making an emergency call

Dial the emergency call number (e.g. 112).

The telephone connection to the emergency call centre is set up.

Answer when the service personnel questions you about the emergency.

⚠ Warning

Do not end the call until you are requested to do so by the emergency call centre.

Operation

As soon as a connection via Bluetooth has been set up between your mobile phone and the Infotainment system, you can operate many functions of your mobile phone via the Infotainment system.

Note

In the hands-free mode, mobile phone operation continues to be possible, e.g. taking a call or adjusting the volume.



After setup of a connection between the mobile phone and the Infotainment system, mobile phone data is transmitted to the Infotainment system. This can take some time depending on the mobile phone and the amount of data to be transferred. During this period, operation of the

mobile phone via the Infotainment system is possible only to a limited extent.

Note

Not every mobile phone supports all functions of the phone portal. Therefore, deviations from the range of functions described below are possible.

Phone main menu

Press  and then select  in the top left corner of the screen to display the application overview screen.

Select **Phone** to display the phone main menu.



Initiating a phone call

Entering a phone number

Press and then select in the top left corner of the screen to display the application overview screen.

Select **Phone**.

Enter a telephone number using the keypad in the phone main menu.

To delete one or more entered characters, touch or touch and hold .

Touch on the screen to start dialling.

Phone book

When pairing a mobile phone with the Infotainment system via Bluetooth, the phone book of the mobile phone is downloaded automatically 133.

Press and then select in the top left corner of the screen to display the application overview screen.

Select **Phone**.

Activate the tab in the phone main menu.



To start a phone call, select the desired contact in the list.

Note

To display a contact with all information available, select **More** next to the desired contact.

Contacts sorting

The phone book can be sorted by last name or first name.

Press and then select in the top left corner of the screen to display the application overview screen.

Select **Settings** to display the respective menu.

Select **Bluetooth Phone** and then **Sort contacts**. Activate the desired option.

Call history

All incoming, outgoing, or missed calls are registered.

Press and then select in the top left corner of the screen to display the application overview screen.

Select **Phone**. Select the tab in the phone main menu.

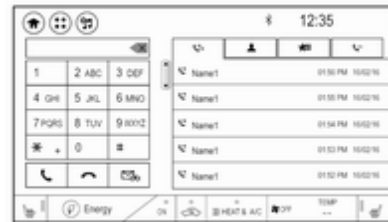



Outgoing calls are marked with , incoming calls are marked with and missed calls are marked with .

Select the desired list entry to initiate a phone call.



Favourites



Contact favourites can be stored in the phone favourites list.

Storing favourites

Press  and then select  in the top left corner of the screen to display the application overview screen.

Select **Phone**. Select the  tab in the phone main menu.



Select  next to the contact you want to store as favourite. The icon changes to  and the contact appears in the favourites list.

Select  again to delete the contact from the favourites list. The icon changes to .

Note

The favourites list is not synchronised with the phone favourites. The favourites have to be added to the favourites list on the Infotainment system.

Retrieving favourites



Press  and then select  in the top left corner of the screen to display the application overview screen.

Select **Phone**. Select the  tab in the phone main menu.

Select the desired favourite to initiate a phone call.

Redialling a number



The last dialled phone number can be redialled.

Press  and then select  in the top left corner of the screen to display the application overview screen.

Select **Phone** and then  on the screen.

Using speed dial numbers

Speed dial numbers that are stored on the mobile phone can also be dialled using the keypad of the phone main menu.

Press  and then select  in the top left corner of the screen to display the application overview screen.



Select **Phone**.

Touch and hold the respective digit on the keypad to initiate the call. For two-digit speed dial numbers, select the first digit and then touch and hold the second digit.

Incoming phone call



Taking a call

If an audio mode, e.g. the radio or USB mode, is active at the moment a call comes in the audio source is muted and stays muted until the call ends.

To answer the call, select  in the message on top of the screen or press  on the steering wheel.



The  tab is activated displaying information on the call.

Rejecting a call

To reject the call, select  in the message on top of the screen or press  on the steering wheel.

Privacy settings

When a call comes in, a message is displayed on the Info Display indicating the name and number of the person calling (if available). If **Privacy** is activated, information on the caller is only shown in the cluster display.

Press  and then select  in the top left corner of the screen to display the application overview screen.

Select **Settings** and then **Bluetooth Phone**. Activate or deactivate **Privacy**.

Functions during a call

During an ongoing phone call the phone main menu is displayed.

Deactivating the hands-free mode temporarily

To continue the conversation on the mobile phone, activate .

To return to the hands-free mode, deactivate .

Deactivating the microphone temporarily

To mute the microphone, activate .

To reactivate the microphone, deactivate .

Setting a call on hold

During an active phone call, the  screen button changes to **Hold**.

Select **Hold** to set the call on hold.



Ending a phone call

Select  to end the call.

Voice mail box

You may operate your voice mail box via the Infotainment system.



Voice mail number

To check the voice mail number of the phone currently connected, press  and then select  in the top left corner of the screen.

Select **Settings** and then **Bluetooth Phone**.

If available, the voice mail number is displayed under **My Number**.

Calling the voice mail box

Press  and then select  in the top left corner of the screen to display the application overview screen.

Select **Phone** to display the phone main screen.

Select  on the keypad to call the mailbox.

Alternatively, enter the voice mail number via the phone keypad.

Mobile phones and CB radio equipment

Installation instructions and operating guidelines

The vehicle specific installation instructions and the operating guidelines of the mobile phone and hands-free manufacturer must be observed when installing and operating a mobile telephone. Failure to do so could invalidate the vehicle operating permit (EU directive 95/54/EC).

Recommendations for fault-free operation:

- Professionally installed exterior antenna to obtain the maximum range possible
- Maximum transmission power 10 W
- Installation of the phone in a suitable spot, consider relevant Note in the Owner's Manual  45

Seek advice on predetermined installation points for the external antenna or equipment holder and ways of using devices with a transmission power exceeding 10 W.

Use of a hands-free attachment without external antenna with mobile telephone standards GSM 900/1800/1900 and UMTS is only permitted if the maximum transmission power of the mobile telephone is 2 W for GSM 900 or 1 W for the other types.

For reasons of safety, do not use the phone while driving. Even use of a hands-free set can be a distraction while driving.

⚠ Warning

Operation of radio equipment and mobile telephones which fail to meet above mentioned mobile telephone standards is only permitted using an antenna located outside of the vehicle.

Caution

Mobile telephones and radio equipment may lead to malfunctions in the vehicle electronics when operated inside the vehicle with no exterior antenna, unless the above mentioned regulations are observed.

Climate control

Climate control systems	141
Electronic climate control system	141
Air vents	145
Adjustable air vents	145
Fixed air vents	145
Maintenance	146
Air intake	146
Air conditioning regular operation	146
Service	146

Climate control systems

Electronic climate control system





Note

Do not cover the sensor located on top of the instrument panel, otherwise the automatic climate control system may not work properly.



In automatic mode, temperature, fan speed and air distribution are regulated automatically.



Controls for:

- temperature
- air distribution  ,  , 
- fan speed 
- automatic mode **AUTO**
- demisting and defrosting  **MAX**



Heated rear window   35.

Heated exterior mirrors   33.

Climate touch screen controls



- system on or off **ON/OFF**
- heating **HEAT**
- cooling **A/C**

- manual air recirculation 
- Heated seats   41

Automatic mode AUTO



Basic setting for maximum comfort:

- Press **AUTO**, the air distribution and fan speed are regulated automatically. The LED in the button illuminates to indicate activation.
- Touch **HEAT** or **A/C** to switch on optimal heating or cooling and demisting. The LED in the button illuminates to indicate activation.

- Set the preselected temperature by turning rotary knob **TEMP**. Recommended temperature is 22 °C.
- Open all air vents to allow optimised air distribution in automatic mode.

The fan speed regulation in automatic mode can be changed in the Info Display.

Vehicle personalisation ⇨ 90.

Temperature preselection



Set temperature to the desired value.

The selected temperature is indicated in the display.

Note



The preselected temperature is only achieved if **HEAT** or **A/C** is switched on.



If the minimum temperature **Lo** is set, the climate control system runs at maximum cooling, when **A/C** is switched on.

If the maximum temperature **Hi** is set, the climate control system runs at maximum heating when **HEAT** is switched on.

Demisting and defrosting the windows MAX



- Press  **MAX**. The LED in the button illuminates to indicate activation. When  **MAX** is selected, air is directed to the windscreen and the fan runs at a higher speed. Fog or frost is cleared from the windscreen more quickly.
- Temperature and air distribution are set automatically and the fan runs at high speed.

- Switch on heated rear window  **REAR**.
- To return to previous mode: press , to return to automatic mode: press **AUTO**.

Settings of automatic rear window heating can be changed in the Info Display.

Vehicle personalisation ⇨ 90.

System activation ON/OFF

Cooling, fan and automatic mode can be switched off by pressing **ON/OFF**.

Manual settings

Climate control system settings can be changed by activating the buttons and rotary knobs as described below. Changing a setting will deactivate automatic mode.

Fan speed

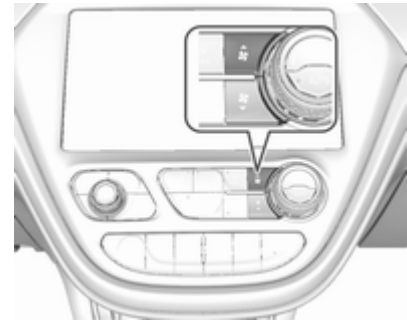

Press lower button to decrease or upper button to increase fan speed. The fan speed is indicated in the lower display area.



If the fan is switched off, the air conditioning is also deactivated.

To return to automatic mode: Press **AUTO**.

Air distribution ,  and 



Press the appropriate button for the desired adjustment. The LED in the button illuminates to indicate activation.

-  : to head area via adjustable air vents
-  : to foot well and windscreen
-  : to windscreen

Combinations are possible.

To return to automatic air distribution: press **AUTO**.

Manual air recirculation 



Touch  to activate the air recirculation mode.

Touch  again to deactivate recirculation mode.

If selected, the touch screen button will illuminate to indicate that air is being recirculated. This helps to quickly cool the air inside the vehicle or prevent outside air and odours from entering.

Touching  deactivates air recirculation. Press **AUTO** to return to automatic operation. Recirculation runs automatically as needed.

 Warning

The exchange of fresh air is reduced in air recirculation mode. In operation without cooling the air humidity increases, so the windows may mist up from inside. The quality of the passenger compartment air deteriorates, which may cause the vehicle occupants to feel drowsy.

Remote heating and cooling

Operated by pressing  on the electronic key.

The climate control system will default to an appropriate heating or cooling mode and the rear window heating will turn on in the event of cold outside temperatures.

Remote start  17.

Air vents

Adjustable air vents

At least one air vent must be open while cooling is on.

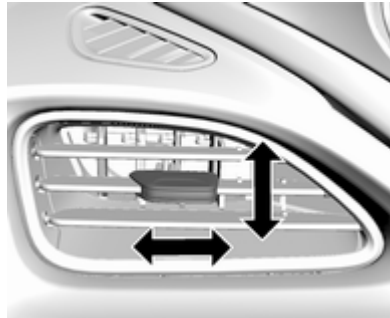
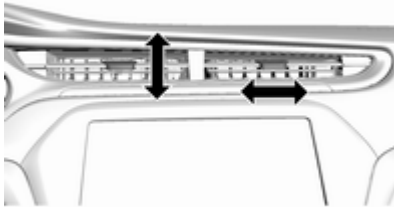

Direct the flow of air by tilting and swivelling the slats.

The airflow may be restricted if the slats are directed towards the windows. Keep the air vents open for proper system performance.

Warning

Do not attach any objects to the slats of the air vents. Risk of damage and injury in case of an accident.

Fixed air vents

Additional air vents are located beneath the windscreen and door windows and in the foot wells.

Maintenance

Air intake

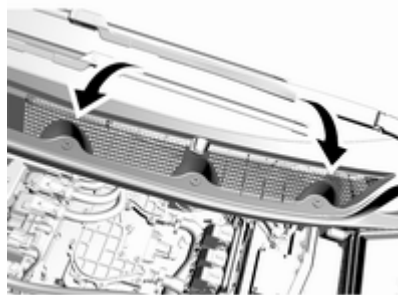

The air intake in front of the windscreen in the engine compartment must be kept clear to allow air intake. Remove any leaves, dirt or snow.

Air conditioning regular operation

In order to ensure continuously efficient performance, cooling must be operated for a few minutes once a month, irrespective of the weather and time of year. Operation with cooling is not possible when the outside temperature is too low.

Service

For optimal cooling performance, it is recommended to annually check the climate control system, starting three years after initial vehicle registration, including:

- functionality and pressure test
- heating functionality
- leakage check
- check of drive belts
- cleaning of condenser and evaporator drainage
- performance check

Driving and operating

Driving hints	147
Driving economically	147
Control of the vehicle	148
Emergencies	148
Starting and operating	148
New vehicle running-in	148
Power button	148
Retained power off	150
Starting and stopping the vehicle	150
Parking	151
Electric vehicle operation modes	153
Operation	153
Drive modes	153
Electric drive unit	153
Operation	153
Brakes	157
Antilock brake system	157
Parking brake	158
Regenerative braking	160

Ride control systems	161
Traction Control system	161
Electronic Stability Control	162
Driver assistance systems	163
Cruise control	163
Speed limiter	164
Forward collision alert	166
Following distance indication ...	168
Active emergency braking	168
Front pedestrian protection	171
Parking assist	173
Side blind zone assistant	180
Lane change alert	181
Panoramic view system	183
Rear view camera	184
Rear cross traffic alert	186
Traffic sign assistant	187
Lane keep assist	190
Charging	192
Programmable charging	196
Programmed charging override	203
Charging status	203
Charge cord	205
Electrical requirements	208

Driving hints

Driving economically

The following advice is intended to help maximise energy efficiency and range.

In colder temperatures, while these efficiency tips will help, the electric vehicle's driving range may be lower due to higher energy usage.

The weight of additional cargo in the vehicle affects efficiency and range. Avoid carrying more than is needed.

Avoid unnecessary use of electrical accessories. Power used for functions other than propelling the vehicle will reduce electric vehicle range.

Always keep the tyres properly inflated and the vehicle properly aligned.

Driving style

Avoid unnecessary rapid accelerations and decelerations.

Use cruise control when appropriate.

Avoid shifting to **N** to coast. The vehicle recovers energy while coasting and braking in **D** or **L**.

Efficiency gauge in the instrument cluster

Driving efficiency gauge ⇨ 74.

Drive mode and gear mode selection

Use normal drive mode when possible.

Sport mode provides more responsive acceleration than normal mode but can reduce energy efficiency.

Use **L** in heavy stop-and-go traffic or when travelling downhill. **L** requires less brake pedal application and provides a controlled, efficient way to slow the vehicle down.

Control of the vehicle

Caution

Drive carefully whenever the road has a steep incline or when driving over a ramp or bump, etc.

Pedals

To ensure the pedal travel is uninhibited, there must be no mats in the area of the pedals.

Use only floor mats, which fit properly and are fixed by the retainers on the driver side.

Emergencies

⚠ Warning

Damage to the high voltage battery or high voltage system can create a risk of electric shock, overheating, or fire. If the vehicle is damaged from a moderate to severe crash, flood, fire, or other event, the vehicle should be inspected as soon as possible by a workshop. Until the vehicle has been inspected, store it outside at least 7.5 m from any structure or anything that can burn.

Starting and operating

New vehicle running-in

Avoid making hard stops for the first 300 km.

Hard stops with new brake linings can lead to premature wear. Follow this breaking-in guideline every time you get new brake linings. Following break-in, vehicle speed and load can be gradually increased.

Power button

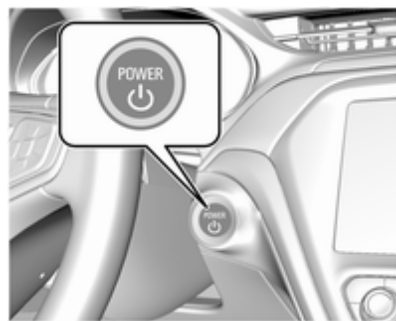

Electronic key must be inside the vehicle.

If the vehicle will not start, place the electronic key in the transmitter pocket inside the centre console.

Starting and stopping the vehicle
▷ 150.

Switching on the vehicle

With the vehicle off and the brake pedal applied, pressing **POWER** once will switch on the vehicle. When  illuminates in the instrument cluster, the vehicle is ready to be driven. This could take up to 15 seconds at extremely cold temperatures.

Switching off the vehicle

With the vehicle in **P**, press **POWER** briefly in service mode or when engine is running and vehicle is stationary. Some functions remain active until driver's door is opened.

If the vehicle is not in **P** when switching off the vehicle, **P** will be automatically engaged before the vehicle is switched off.

A chime will sound if the driver's door is opened while the vehicle is switched on. Always press **POWER** to switch off the vehicle before exiting the vehicle.

Emergency shut off during driving

If the vehicle needs to be switched off during driving in case of emergency, press **POWER** for more than 2 seconds or press twice briefly within 5 seconds.

Starting and stopping the vehicle
▷ 150.

Service mode

This power mode is available for service and diagnostics and to verify the proper operation of the service vehicle soon control indicator as may be required for emission inspection purposes.

With the vehicle switched off and the brake pedal not applied, pressing and holding **POWER** for more than 5 seconds will place the vehicle in service mode. The instruments and audio systems will operate as they do when the vehicle is switched on, but the vehicle will not be able to be

driven. The propulsion system will not start in service mode. Press **POWER** again to switch off the vehicle.

Caution

Service mode will discharge the 12 V vehicle battery. Do not use service mode for an extended period, or the vehicle may not start.

Operation in case of failure

If the vehicle does not start due to a low electronic key battery, a message will be displayed in the Driver Information Centre.

To still drive the vehicle, proceed as follows:

1. Open the centre console and remove the small tray from the centre console. Place the electronic key in the pocket with the buttons facing the bottom of the vehicle.

Other objects, e.g. other keys, transponder, tags, coins etc. must be removed.

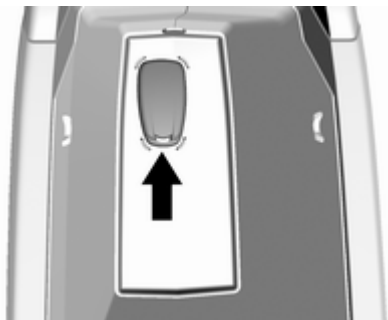

2. With selector lever in **P** or **N** depress the brake pedal and press **POWER** .

To switch off the vehicle, press **POWER**  again. Remove the electronic key from the centre console.

This option is intended for emergencies only. Replace the electronic key battery as soon as possible  19.

For unlocking or locking the doors, see fault in radio remote control unit or electronic key system  20.

Retained power off

The following electronic systems can work until the driver's door is opened or for 10 minutes after the vehicle is switched off:

- power windows
- Infotainment system
- power outlets

Starting and stopping the vehicle

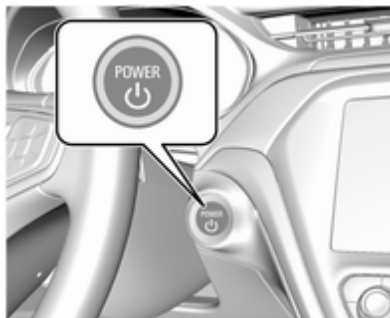

Move the selector lever into **P** or **N**. The propulsion system does not start in any other position.

Note

Do not try to shift into **P** when the vehicle is moving, as the electric drive unit could be damaged. Shift into **P** only when the vehicle is stationary.

The electronic key must be inside the vehicle. Depress the brake pedal, then press **POWER** .

If the electronic key is not in the vehicle or something is interfering with the transmitter, a message is displayed in the Driver Information Centre.



A vehicle ready light is displayed in the lower right corner of the instrument cluster when the vehicle is ready to be driven.

The instrument cluster also displays an active battery gauge when the vehicle is ready to be driven.

A chime will sound if the driver's door is opened while the vehicle is switched on. Always press **POWER**  to switch off the vehicle before exiting the vehicle.

If the vehicle will not start due to a low electronic key battery, the vehicle can still be driven.



Operation in case of failure ⇨ 148.

Restarting

Caution

If the vehicle must be restarted while it is still moving, move the selector lever into **N** and press **POWER**  twice without depressing the brake pedal. The propulsion system will not restart in any other way.

Emergency shut off during driving

1. Brake using a firm and steady pressure. Do not pump the brakes repeatedly. This may reduce power assist, requiring increased brake pedal force.
2. Shift the selector lever into **N**. This can be done while the vehicle is moving. After shifting into **N**, firmly apply the brakes and steer the vehicle to a safe location.
3. Come to a complete stop, shift into **P**, and switch off the vehicle by pressing **POWER** .
4. Apply the parking brake.
If the vehicle cannot be pulled over and must be shut off while driving, press and hold **POWER**  for more than 2 seconds, or press twice briefly within 5 seconds.

Danger

Switching off the vehicle while moving may disable the airbags. While driving, only shut the propulsion system off in an emergency.

Starting the vehicle at low temperatures

It is recommended to plug in the vehicle when exterior temperatures are below 0 °C to maximise high voltage battery life.





Should the exterior temperature be lower than -32 °C, the vehicle must be plugged in when the vehicle is switched on.

Parking

Note

Do not allow the vehicle to remain in extreme temperatures for long periods without being driven or being plugged in.

⚠ Warning

- Always apply parking brake. Pull switch  for approx. 1 second and check if the control indicator  illuminates. The electric parking brake is applied when control indicator  illuminates  79.
 - Switch off the vehicle.
 - If the vehicle is on a level surface or uphill slope, apply the parking brake and set the selector lever to **P** before switching off the vehicle. On an uphill slope, turn the front wheels away from the kerb.
- If the vehicle is on a downhill slope, apply the parking brake and set the selector lever to **P** before switching off the vehicle. Turn the front wheels towards the kerb.
- With the selector lever in **P**, press **POWER**  briefly to switch off the vehicle. Turn the

steering wheel until the steering wheel lock engages.

- Close the windows.
- Lock the vehicle.
- Activate the anti-theft alarm system.
- The engine cooling fans may run after the vehicle has been switched off  211.

It is not recommended to park with the propulsion system running.

If the vehicle is left with the propulsion system running, follow the proper steps to be sure the vehicle will not move.

Post-crash label



The post-crash label is located in the driver's door frame.

After an accident, park the vehicle with a sufficient distance of approx. 7.5 m to other objects.

Park on a non-flammable surface.

Call the hotline number given on the label to get further instructions on how to handle the vehicle.

Electric vehicle operation modes

Operation

This vehicle is a purely electrically driven vehicle. It always uses an electric propulsion system to drive the vehicle. Electricity is the vehicle's only source of energy.

Drive modes

Sport mode



Sport mode provides more responsive acceleration than normal mode, but can reduce energy efficiency. Use normal mode whenever possible.

When the **SPORT** indicator does not illuminate, the vehicle is in normal mode.

Press **SPORT** to select Sport mode.

Press **SPORT** again to return to normal mode.

The **SPORT** indicator will be displayed in the instrument cluster when Sport mode is selected.

Control indicator ⇨ 80.

When Sport mode is active and the vehicle is switched off, Sport mode will still be active when the vehicle is switched on again.

Sport mode may be unavailable if the high voltage battery charge is too low.

Electric drive unit

Operation

The vehicle uses an electric drive unit with a 1-gear transmission. The selector lever is located on the centre console between the seats.



- P** : park position, wheels are locked, engage only when the vehicle is stationary
- R** : reverse gear, engage only when the vehicle is stationary
- N** : neutral
- D** : drive mode, low recuperation
- L** : low, high recuperation, enables one pedal drive

The selector lever always starts from a centre position. The selected gear is indicated by a yellow LED on the selector lever. After releasing the selector lever, it will return to the centre position.

P: This position locks the front wheels. It is the recommended position when starting the propulsion system because the vehicle cannot move easily.

⚠ Warning

It is dangerous to get out of the vehicle if the selector lever is not fully in **P** with the parking brake firmly applied. The vehicle can roll.

Do not leave the vehicle when the propulsion system is running, the vehicle may move suddenly. You or others can be injured. To be sure the vehicle will not move, even if you are on even ground, always apply the parking brake and move the selector lever to **P**.



The release button is designed to prevent inadvertent shifting out of **P** unless the vehicle has been started, the brake pedal is depressed, and the release button is pressed.

When the vehicle is stopped, press **POWER**  to switch off the vehicle. The electric drive unit will shift to **P** automatically.

The vehicle will not shift into **P** if it is moving too fast. Stop the vehicle and shift into **P**.

To shift into **P**, press the **P** button on the selector lever.

To shift out of **P**:

1. Depress the brake pedal and press the release button.
2. Shift into the desired gear.

R: Use this gear to reverse.

If the vehicle is shifted from either **R** to **D**, or **D** to **R** while the speed is too high, the vehicle will shift automatically to **N**. Stop the vehicle and shift again.

To shift into and out of **R**:

1. Bring the vehicle to a complete stop.
2. To shift into **R**, press the release button and move the selector lever forward, and then to the left. **R** is illuminated in red.

To shift out of **R**, shift into the desired gear.

Caution

Shifting into **R** while the vehicle is moving forward could damage the electric drive unit. Only shift into **R** after the vehicle has been stopped.

At low vehicle speeds, **R** can be used to rock the vehicle back and forth to get out of snow, ice, or sand without damaging the electric drive unit.

N: In this position, the propulsion system does not transfer torque to the wheels. To restart the propulsion system when the vehicle is already moving, use **D** only.

The vehicle is not designed to stay in **N** for extended periods of time. It will automatically shift into **P**.

To shift into and out of **N**:

- To shift into **N**, move the selector lever forward until **N** is illuminated in red.
- If the vehicle is in **P**, press the release button while pressing the selector lever forward until **N** is illuminated in red.

To shift out of **N**, bring the vehicle to a complete stop and shift into the desired gear.

D: This position is for normal driving. If more power is needed for passing, and the vehicle speed is:

- less than 56 km/h, push the accelerator pedal about halfway down.
- about 56 km/h or more, push the accelerator pedal all the way down.

Caution

If the vehicle seems to accelerate slowly or not respond when you try to go faster, do not continue your journey. The electric drive unit could be damaged. Consult a workshop as soon as possible.

Note

In slippery conditions, operate the vehicle in **D** for enhanced riding and handling performance.

To shift into and out of **D**:

1. Bring the vehicle to a complete stop.
2. To shift into **D**, move the selector lever back. If the vehicle is in **P**,

press the release button while pressing the selector lever back. **D** is illuminated in red.

To shift out of **D**, shift to the desired gear.

When stopping on a steep hill, use the brakes to hold the vehicle in place.

When shifting into **P** on a hill, use the brakes to hold the vehicle. Then shift into **P**.

L: This position reduces vehicle speed without using the brakes. Use **L** on very steep hills, in deep snow, in mud or in stop-and-go traffic.

Caution

Spinning the tyres or holding the vehicle in one place on a hill using only the accelerator pedal may damage the electric drive unit. If you are stuck, do not spin the tyres. When stopping on a hill, use the brakes to hold the vehicle in place.

One-pedal driving

Caution

When the vehicle is operated in **L** and the driver unfastens his seat belt, the electric parking brake is automatically applied and one pedal driving is not possible.

With one-pedal driving, the accelerator pedal can be used to control the deceleration of the vehicle down to a complete stop.

Quick releasing of the accelerator pedal will result in aggressive deceleration. Slow releasing of the accelerator pedal will allow the deceleration of the vehicle to be adjusted as desired.

To use one-pedal driving, shift into **L**. **L** is only selectable when the vehicle is in **D**. Press the accelerator pedal to achieve the desired speed. The deceleration provided by one-pedal driving provides full regenerative braking and helps increase energy efficiency.

While operating in one-pedal driving, the electric parking brake may apply in some circumstances. This can occur when:

- Driving on slopes.
- The driver's door is open.
- The vehicle has remained stationary for 5 minutes.
- There is a problem with the propulsion system.

To drive again, depress the accelerator pedal, and the electric parking brake will automatically disengage.

One-pedal driving may shift the vehicle into **P** if the vehicle is pushed once it has been stopped or if a problem with the propulsion system develops.

Regenerative braking ⇨ 160.

Car wash mode

This vehicle includes a car wash mode that allows the vehicle to remain in **N** (neutral) for use in automatic car washes.

Car wash mode (vehicle off) - driver in vehicle

To place the vehicle in **N** with the vehicle off and occupied:

1. Apply the brake pedal.
2. Shift to **N**.
3. Turn off the vehicle and release the brake pedal.
4. The indicator should continue to show **N**. If it does not, repeat steps 1-3.

The vehicle is now ready for the car wash.

Car wash mode (vehicle off) - driver out of vehicle

To place the vehicle in **N** with the vehicle off and unoccupied:

1. Apply the brake pedal.
2. Open the door.
3. Shift to **N**.
4. Turn off the vehicle and release the brake pedal.

5. The indicator should continue to show **N**. If it does not, repeat steps 1-4.

6. Exit the vehicle and close the door.

The vehicle is now ready for the car wash.

Car wash mode (vehicle on) - driver in vehicle

To place the vehicle in **N** with the vehicle on and occupied:

1. Apply the brake pedal.
2. Shift to **N**.
3. Release the brake pedal.

The vehicle is now ready for the car wash.

Car wash mode (vehicle on) - driver out of vehicle

To place the vehicle in **N** with the vehicle on and unoccupied:

1. Apply the brake pedal.
2. Open the door.
3. Shift to **N**.
4. Release the brake pedal.

5. The indicator should continue to show **N**. If it does not, repeat steps 1-4.

6. Exit the vehicle and close the door.

The vehicle is now ready for the car wash.

The vehicle may have automatically shifted to **P** upon re-entry.

Brakes

The brake system comprises two independent brake circuits.

If a brake circuit fails, the vehicle can still be braked using the other brake circuit. However, braking effect is achieved only when the brake pedal is depressed firmly. Considerably more force is needed for this. The braking distance is extended. Seek the assistance of a workshop before continuing the journey.

When the vehicle is switched off, the support of the brake servo unit disappears once the brake pedal has been depressed once or twice. Braking effect is not reduced, but braking requires significantly greater force. It is especially important to bear this in mind when being towed.

Control indicator (D) ⇨ 79.

Antilock brake system

Antilock brake system (ABS) prevents the wheels from locking.

ABS starts to regulate brake pressure as soon as a wheel shows a tendency to lock. The vehicle remains steerable, even during hard braking.

ABS control is made apparent through a pulse in the brake pedal and the noise of the regulation process.

For optimum braking, keep the brake pedal fully depressed throughout the braking process, despite the fact that the pedal is pulsating. Do not reduce the pressure on the pedal.

After starting off, the system performs a self-test which may be audible.

Control indicator (ABS) ⇨ 79.

Fault

Warning

If there is a fault in the ABS, the wheels may be liable to lock due to braking that is heavier than normal. The advantages of ABS are no longer available. During

hard braking, the vehicle can no longer be steered and may swerve.

Have the cause of the fault remedied by a workshop.

Parking brake

Electric parking brake



The electric parking brake can always be activated, even if the vehicle is switched off.

Do not operate electric parking brake system too often when the vehicle is switched off as this will discharge the 12 V vehicle battery.

In case of insufficient electric power, the electric parking brake cannot be applied or released.

Applying when vehicle is stationary

Warning

Pull switch (P) for a minimum of 1 second until control indicator (P) illuminates constantly and electric parking brake is applied ⇨ 79. The electric parking brake operates automatically with adequate force.

Before leaving the vehicle, check the electric parking brake status.

Control indicator (P) ⇨ 79.

1. Be sure the vehicle is at a complete stop.
2. Pull switch (P) for approx. 1 second.

The control indicator (P) will flash and then stay on once the electric parking brake is fully applied. Before leaving the vehicle, check the control indicator (P) to ensure the parking brake is applied.

If the control indicator (P) flashes continuously, then the electric parking brake is only partially applied or there is a problem with the electric parking brake. A message is displayed in the Driver Information Centre. Release the electric parking brake and try to apply it again. If the control indicator (P) does not illuminate or keeps flashing, seek the assistance of a workshop.

Do not drive the vehicle if the control indicator (P) is flashing ⇨ 79.

If the electric parking brake is applied while the vehicle is moving, a chime will sound and a message will be displayed in the Driver Information Centre. The vehicle will decelerate as long as the switch is pulled.

Releasing the switch (P) during the deceleration process will release the parking brake. If the switch (P) is

pulled until the vehicle stops moving, the electric parking brake will remain applied.

When the electric parking brake fault indicator (P) illuminates, the electric parking brake has detected a system problem and is operating with reduced functionality. To apply the electric parking brake when (P) illuminates, pull the switch (P) and hold it until the control indicator (P) remains on. If the control indicator (P) illuminates, seek the assistance of a workshop.

The vehicle may automatically apply the electric parking brake in some situations when the vehicle is not moving. This is normal, and is done to periodically check the correct operation of the electric parking brake system.

If the electric parking brake fails to apply, the rear wheels should be blocked to prevent vehicle movement.

Releasing

1. Switch on the vehicle.
2. Keep brake pedal depressed.
3. Push switch (P).

If attempting to release the electric parking brake without the brake pedal being applied, a chime will sound and a message will be displayed in the Driver Information Centre. The electric parking brake is released when (P) is off.

If control indicator (P) is illuminated, the electric parking brake has detected a system problem, and is operating with reduced functionality. To release the electric parking brake when (P) is on, push down the switch (P) and hold it down until the control indicator (P) goes off. If the control indicator remains illuminated, seek the assistance of a workshop.

Note

Driving with the parking brake on can overheat the brake system and cause premature wear or damage to brake system parts. Make sure that

the parking brake is fully released and the control indicator (P) is off before driving.

Automatic release

The electric parking brake is automatically released when the vehicle is running, placed into gear and an attempt is made to drive away. Avoid rapid acceleration when the electric parking brake is applied, to reduce wear of parking brake lining.

Electric parking brake control indicator (P) ⇨ 79.

Electric parking brake fault control indicator (P) ⇨ 79.

Driver Information Centre ⇨ 82.

Regenerative braking

Some braking energy from the moving vehicle is turned back into electrical energy. This energy is then stored back into the high voltage battery system, increasing energy efficiency.

Regenerative power may be limited when the high voltage battery is near full charge or cold.

Regeneration on demand

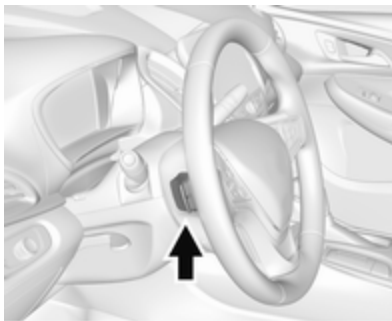

Regeneration on demand allows increased deceleration by pressing and holding the steering wheel paddle. It works in **D** (Drive) and **L** (Low). The accelerator pedal must be mostly released for it to work.

If regenerative braking is active, the regenerative active icon with arrows is shown as green.

Regenerative braking ⇨ 76.

Cruise control will switch off and the brake lights may come on when this feature is activated.

If the vehicle is in **D** (Drive) and is brought to a complete stop while the regenerative braking paddle is held, the vehicle will not creep forward when the paddle is released. The accelerator pedal must be pressed to move the vehicle forward.

One-pedal driving ⇨ 153.

If the vehicle is on a steep gradient, the brake pedal will be required to hold the vehicle.

The brake controller applies the hydraulic brakes using a pump. You may hear the pump during some braking manoeuvres, such as rapid brake application or during regenerative braking as the vehicle comes to a stop. This is normal operation.

Ride control systems

Traction Control system

The Traction Control system (TC) is a component of the Electronic Stability Control (ESC).

TC improves driving stability when necessary, regardless of the type of road surface or tyre grip, by preventing the drive wheels from spinning.

As soon as the drive wheels starts to spin, electric drive unit output is reduced and the wheel spinning the most is braked individually. This considerably improves the driving stability of the vehicle on slippery road surfaces.



TC is operational as soon as the control indicator  extinguishes.

When TC operates  flashes.

Warning

Do not let this special safety feature tempt you into taking risks when driving.

Adapt speed to the road conditions.

Control indicator   80.

Deactivation



TC can be switched off when spinning of drive wheels is required: press  briefly.



Control indicator  illuminates.

When TC is deactivated, ESC remains active but with a higher control threshold.

TC is reactivated by pressing  again.

TC is also reactivated the next time the vehicle is switched on.

Caution

Do not repeatedly brake or accelerate heavily if TC is off. The vehicle's driveline could be damaged.

Fault

If there is a fault in the system the control indicator  illuminates continuously and a message appears in the Driver Information Centre. The system is not operational.



Have the cause of the fault remedied by a workshop.

Electronic Stability Control

Electronic Stability Control (ESC) improves driving stability when necessary, regardless of the type of road surface or tyre grip.

As soon as the vehicle starts to swerve (understeer / oversteer), electric drive unit output is reduced and the wheels are braked individually. This considerably improves the driving stability of the vehicle on slippery road surfaces.



ESC is operational as soon as the control indicator  extinguishes. When ESC operates  flashes.

Warning

Do not let this special safety feature tempt you into taking risks when driving.



Adapt speed to the road conditions.

Control indicator   80.

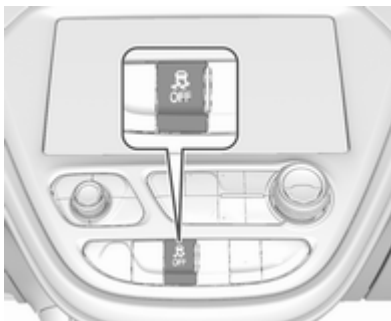
Deactivation



For very high-performance driving, ESC can be deactivated:

Press and hold  until  and  illuminate.

ESC is reactivated by pressing the  button again.

If cruise control is being used when ESC is activated, cruise control will automatically disengage. Press the cruise control button to re-engage if road conditions allow.

Cruise control  163.

Fault

If there is a fault in the system the control indicator  illuminates continuously and a message appears in the Driver Information Centre. The system is not operational.

Have the cause of the fault remedied by a workshop.

Resetting

If  illuminates and remains illuminated, reset the system as follows:

1. Stop the vehicle.
2. Switch off the vehicle and wait for 15 seconds.
3. Switch on the vehicle.

If  still illuminates and remains illuminated, seek the assistance of a workshop.

Driver assistance systems

Warning

Driver assistance systems are developed to support the driver and not to replace the driver's attention.

The driver stays in full control of the vehicle and accepts full responsibility when driving the vehicle.

When using driver assistance systems, always take care regarding the current traffic situation and follow applicable traffic rules.

Cruise control

The cruise control can store and maintain speeds of approx. 25 km/h or more.

Deviations from the stored speeds may occur when driving uphill or downhill.

With the Traction Control system or Electronic Stability Control, the system may limit wheel spin while using cruise control. If this happens, the cruise control will automatically disengage.

Traction Control system ⇨ 161.

Electronic Stability Control ⇨ 162.

If a collision alert occurs when cruise control is activated, cruise control is disengaged.



Forward collision alert ⇨ 166.



Do not use the cruise control if it is not advisable to maintain a constant speed.

Switching on the system



Press , control indicator  in instrument cluster illuminates white and cruise control is on standby. Press  again to deactivate cruise control.

Activation of the functionality

Accelerate to the desired speed and press **SET/-**, the current speed is stored and maintained. The desired set speed briefly appears in the instrument cluster. Accelerator pedal can be released.

Vehicle speed can be increased by depressing the accelerator pedal. When the accelerator pedal is released, the previously stored speed is resumed.

Control indicator   81.

Increase speed

With cruise control active, press **RES/+** until the desired speed is reached or press **RES/+** repeatedly: speed is increased in small increments.



Reduce speed

With cruise control active, press **SET/-** until the desired speed is reached or press **SET/-** repeatedly: speed is decreased in small increments.

Resume speed

If the cruise control is set at a desired speed and then the brakes are applied, the cruise control is disengaged without erasing the set speed from memory. Once the vehicle speed is approx. 25 km/h or higher, press **RES/+**. The vehicle returns to the previously set speed.

Deactivation of the functionality



Press , control indicator  in instrument cluster illuminates white.

Cruise control is deactivated, but not switched off. Last stored speed remains in memory for later speed resume.

Automatic deactivation:

- Vehicle speed is below approx. 25 km/h.
- The brake pedal is depressed.
- The selector lever is in **N**.
- The Traction Control system or Electronic Stability Control is operating.

Switching off the system

Press , control indicator  in instrument cluster extinguishes. The stored speed is deleted.

Speed limiter

The speed limiter prevents the vehicle exceeding a preset maximum speed.

The maximum speed can be set at speeds above 25 km/h.

The driver can only accelerate up to the preset speed. Deviations from the limited speed may occur when driving downhill.

The preset speed limit is displayed in the Driver Information Centre when the system is active.

Activation of the functionality



Press .

If cruise control has been activated beforehand, it is switched off when speed limiter is activated and the control indicator  extinguishes.

Set speed limit

Accelerate to the desired speed and briefly press **SET/-**: the current speed is stored as maximum speed.

Speed limit is displayed in the Driver Information Centre.



Change speed limit

With speed limiter active, press **RES/+** to increase or **SET/-** to decrease the desired maximum speed.

Exceeding the speed limit

When exceeding the limited speed without driver input, the speed will flash in the Driver Information Centre and a chime sounds during this period.

In the event of an emergency, it is possible to exceed the speed limit by depressing the accelerator pedal firmly nearly to the final point. In this case no chime sounds.

Release the accelerator pedal and the speed limiter function is reactivated once a speed lower than the limit speed is obtained.

Deactivation of the functionality

The limited speed will be stored and is indicated in brackets in the Driver Information Centre. Additionally, a corresponding message appears.

Speed limiter is deactivated, but not switched off. Last stored speed remains in memory for later speed resume.

Resume limit speed

Press **RES/+**. The stored speed limit will be obtained.

Switching off the system

Press , the speed limit indication extinguishes in the Driver Information Centre. The stored speed is deleted.

By pressing  to activate cruise control or adaptive cruise control, speed limiter is also deactivated and the stored speed is deleted.

By switching off the vehicle, speed limiter is also deactivated, but the speed limit will be stored for next speed limiter activation.

Forward collision alert

The forward collision alert may help to avoid or reduce the harm caused by front-end crashes.

The forward collision alert uses the front camera system in the windscreen to detect a vehicle directly ahead, in your path, within a distance of approx. 60 m.



A vehicle ahead is indicated by the control indicator .

If a vehicle directly ahead is approached too quickly, a warning chime is sounded.

Additionally, the driver is notified by a flashing red LED stripe which is projected on the windscreen in the driver's field of view.

A precondition is that forward collision alert is not deactivated in the vehicle personalisation  90.

Activation

Forward collision alert operates automatically above 8 km/h, if it is not deactivated in the vehicle personalisation menu.

Alerting the driver

The vehicle ahead control indicator  illuminates green in the instrument cluster when the system has detected a vehicle in the driving path.

The control indicator  changes to yellow when the distance to a preceding moving vehicle gets too small or when approaching another vehicle too rapidly.

Caution

The colour lighting of this control indicator does not correspond to local traffic laws on following distance. The driver bears full responsibility for maintaining safe following distance according to applicable traffic rules, weather and road conditions etc. at all times.

When the time to a potential collision with a vehicle in front gets too small and a collision is imminent, the driver is notified by a flashing red LED stripe which is projected on the windscreen in the driver's field of view.

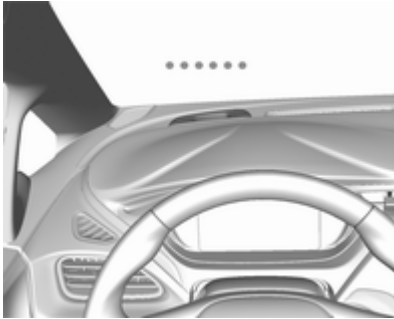



Simultaneously a warning chime sounds. Depress the brake pedal and steer the vehicle, if it is required by the situation.

Selecting the alert sensitivity

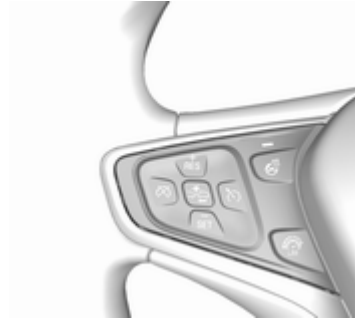
The alert sensitivity to near, medium or far.



Press , the current setting is shown on the Driver Information Centre.

Press  repeatedly to change the alert sensitivity. The selected setting is also displayed in the Driver Information Centre. The last selected setting will be stored when the vehicle is switched off.

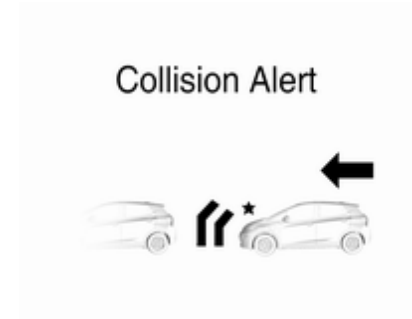

Deactivation

The system can be deactivated in the personalisation menu  90.

The forward collision alert will be activated again with the last selected alert sensitivity when the vehicle is switched on next time.

General information

Warning

Forward collision alert is just a warning system and does not apply the brakes. When

approaching a vehicle ahead too rapidly, it may not provide you enough time to avoid a collision.

The driver accepts full responsibility for the appropriate following distance based on traffic, weather and visibility conditions.

The complete attention of the driver is always required while driving. The driver must always be ready to take action and apply the brakes.

System limitations

Forward collision alert is designed to warn about vehicles only, but may react also to other objects.

In the following cases, forward collision alert may not detect a vehicle ahead or sensor performance is limited:

- on winding roads
- when weather limits visibility, such as fog, rain, or snow
- when the sensor is blocked by snow, ice, slush, mud, dirt, windscreen damage or affected by foreign items, e.g. stickers

Following distance indication

The following distance indication displays the distance in seconds to a preceding moving vehicle. The front camera in the windscreen is used to detect the distance of a vehicle directly ahead in the vehicle's path. It is active at speeds above 8 km/h.

When a preceding vehicle is detected ahead, the distance is indicated in seconds, displayed on a page in the Driver Information Centre.

Following Distance



2.0 sec

Select **Information** menu via steering wheel buttons and press ✓ to select following distance indication ↻ 82.

The minimum indicated distance is 0.5 seconds.

If there is no vehicle ahead or the vehicle ahead is out of range, two dashes will be displayed: -- sec.

Active emergency braking

Active emergency braking can help to reduce the damage and injury from crashes with vehicles, pedestrians and obstacles directly ahead, when a collision can no longer be avoided either by manual braking or by steering. Before the active emergency braking applies, the driver is warned by the forward collision alert ↻ 166 and front pedestrian protection ↻ 171.

The feature uses various inputs (e.g. camera sensor, brake pressure, vehicle speed) to calculate the probability of a frontal collision.

⚠ Warning

This system is not intended to replace the driver responsibility for driving the vehicle and looking ahead. Its function is limited to

supplemental use only to reduce the vehicle speed before a collision.

The system may not react to animals. After a sudden lane change, the system needs a certain time to detect the next preceding vehicle.

The driver must always be ready to take action and apply the brakes and steer to avoid collisions.

Functionality

If equipped only with front camera the active emergency braking operates in a forward gear above walking speed up to 80 km/h.

A precondition is that the system is not deactivated in the vehicle personalisation menu ↻ 90.

The system includes:

- brake preparation system
- emergency automatic braking
- forward looking brake assist
- front pedestrian protection system

Brake preparation system

When approaching a vehicle ahead or a pedestrian so quickly that a collision is likely, the brake preparation system slightly pressurises the brakes. This reduces the response time, when a manual or automatic braking is requested.

The brake system is prepared so that braking can occur more rapidly.

If equipped only with front camera the system operates up to a speed of 80 km/h.

Emergency automatic braking

After activation of brake preparation system and just before the imminent collision, this function automatically applies limited braking to reduce the impact speed of the collision or prevent a crash.

Depending on the situation, the vehicle may automatically brake moderately or hard. This front automatic braking can only occur if a vehicle ahead is detected, indicated by the vehicle ahead indicator 🚗
↻ 166. On vehicles with front

pedestrian protection, automatic braking can also occur when a pedestrian ahead is detected, indicated by the pedestrian ahead indicator 🚶.

The system operates up to a speed of 80 km/h.

Below a speed of 40 km/h the system can apply full braking.

Emergency automatic braking may slow the vehicle to a complete stop to try to avoid a potential crash. If this happens, emergency automatic braking may engage the electric parking brake to hold the vehicle at a stop. To release, push the electric parking brake switch or firmly depress the accelerator pedal.

⚠ Warning

Emergency automatic braking is an emergency crash preparation feature and is not designed to avoid crashes. Do not rely on the system to brake the vehicle. Emergency automatic braking will

not brake outside of its operating speed range and only responds to detected vehicles.

Forward looking brake assist

In addition to the brake preparation system and emergency automatic braking, the forward looking brake assist function makes the brake assist more sensitive. Therefore, depressing the brake pedal less strongly results in immediate hard braking. This function helps the driver brake quicker and harder before an imminent collision.

The system operates up to a speed of 80 km/h.

⚠ Warning

Active emergency braking is not designed to apply hard autonomous braking or to automatically avoid a collision. It is designed to reduce the vehicle speed before a collision. It may not react to animals. After a sudden

lane change, the system needs a certain time to detect the next preceding vehicle.

The complete attention of the driver is always required while driving. The driver must always be ready to take action and apply the brakes and steer to avoid collisions.

Intelligent brake assist

Intelligent brake assist may activate when the brake pedal is applied quickly by providing a boost to braking based on the speed of approach and distance to a vehicle ahead.

Minor brake pedal pulsations or pedal movement during this time are normal and the brake pedal should continue to be applied as required. Intelligent brake assist will automatically disengage only when the brake pedal is released.

⚠ Warning

Intelligent brake assist may increase vehicle braking in situations when it may not be necessary. You could block the flow of traffic. If this occurs, take your foot off the brake pedal and then apply the brakes as needed.

Front pedestrian protection

Front pedestrian protection ⇨ 171.

Deactivation

Active emergency braking can be deactivated in the personalisation menu in the Info Display ⇨ 90.

If deactivated, a message is displayed in the Driver Information Centre.

We recommend to deactivate the system in the following cases:

- when the vehicle is being towed
- before using an automatic car wash with ignition switched on

- if the windscreen has been damaged close to the camera
- if the front bumper has been damaged

The system is reactivated the next time the vehicle is switched on.

System limitations

In some cases, the active emergency braking system may provide automatic braking in situations that seem to be unnecessary, for instance in parking garages, due to traffic signs in a curve or due to vehicles in another lane. This is normal operation, the vehicle does not need a service. Firmly apply the accelerator pedal if the situation and surroundings permit to override the automatic braking.

In the following cases, active emergency braking performance is limited:

- When driving on winding or hilly roads.
- When not all vehicles are detected, especially vehicles with a trailer, tractors, muddy vehicles, etc.
- When detecting a vehicle when weather limits visibility, such as in fog, rain, or snow.
- During nighttime driving.
- When weather limits visibility, such as fog, rain, or snow.
- When the sensor in the windscreen is blocked by snow, ice, slush, mud, dirt, windscreen damage or affected by foreign items, e.g. stickers.

To avoid malfunction keep the areas of the camera sensor in the windscreen always clear of dirt, dust, ice and snow.

Complete attention is always required while driving, and you should be ready to take action and apply the brakes and / or steer the vehicle to avoid crashes.

Fault

In case the system requires a service, a message is displayed in the Driver Information Centre.

If the system does not work as it should do, vehicle messages are displayed in the Driver Information Centre.

Vehicle messages ⇨ 89.

Front pedestrian protection

The front pedestrian protection system may help avoid or reduce the harm caused by front-end crashes with nearby pedestrians when driving in a forward gear.

The system uses the front camera in the windscreen to detect a pedestrian directly ahead in your path.

The front pedestrian protection system can detect and alert about pedestrians when in a forward gear at speeds between 8 km/h and 80 km/h.

Additionally, the front pedestrian protection system can provide a boost to braking or automatically brake the vehicle.

During daytime driving, the system detects pedestrians up to a distance of approximately 40 m. During nighttime driving, system performance might be limited.

The front pedestrian protection can be set to **Off**, **Alert** or **Alert and Brake** in the vehicle personalisation ↻ 90.

⚠ Danger

Front pedestrian braking does not provide an alert or automatically brake the vehicle, unless it detects a pedestrian.

The system may not detect pedestrians, including children, when the pedestrian is not directly

ahead, not fully visible, not standing upright, or when part of a group.

Front pedestrian protection includes:

- detecting front pedestrian ahead
- front pedestrian alert
- automatic braking

Pedestrian detected ahead



A pedestrian ahead is indicated up to a distance of approximately 40 m by control indicator  in the instrument cluster.

Front pedestrian alert



When the vehicle approaches a detected pedestrian ahead too rapidly, a red flashing LED alert is projected onto the windscreen in the driver's field of view and a warning chime is sounded. The brake system may prepare for driver braking to occur more rapidly which can cause a brief, mild deceleration. Continue to apply the brake pedal as required.

Cruise control may be disengaged when the front pedestrian alert occurs.

Automatic braking

If a crash into a pedestrian directly ahead is imminent and the brakes have not been applied, the braking strength is automatically adapted. This can help to avoid some very low speed pedestrian crashes or reduce pedestrian injury.

Automatic braking levels may be reduced under certain conditions, such as higher speeds.

If this happens, automatic braking may engage the electric parking brake to hold the vehicle at a stop. Release the electric parking brake. A firm press of the accelerator pedal will also release automatic braking and the electric parking brake ⇨ 158.

This system includes intelligent brake assist, and the emergency automatic braking system may also respond to pedestrians.

Active emergency braking ⇨ 168.

Automatic braking can be disabled through vehicle personalisation ⇨ 90.

General information

⚠ Warning

The driver must always be ready to take action and apply the brakes and steer to avoid collisions.

⚠ Warning

Front pedestrian braking may alert or automatically brake the vehicle suddenly in situations where it is unexpected and undesired. It could falsely alert or brake for objects similar in shape or size to pedestrians, including shadows. This is normal operation and the vehicle does not need a service. To override Automatic braking, firmly depress the accelerator pedal, if it is safe to do so.

System limitations

In the following cases, front pedestrian protection may not detect a pedestrian ahead or sensor performance is limited:

- When vehicle speed is out of range from 8 km/h to 80 km/h .
- When the distance to an pedestrian ahead is more than 40 m.
- When weather limits visibility, such as fog, rain, or snow.
- During nighttime driving.
- When the sensor in the windscreen is blocked by snow, ice, slush, mud, dirt, windscreen damage or affected by foreign items, e.g. stickers.

Parking assist

Rear parking assist

⚠ Warning

It is the driver who bears full responsibility for the parking manoeuvre.

Always check the surrounding area while reversing and using the rear parking assist system.

The rear parking assist makes parking easier by measuring the distance between the vehicle and rear obstacles. It informs and warns the driver by giving acoustic signals and display indication.



The system has three ultrasonic parking sensors in the rear bumper.

Activation

After the vehicle is switched on, the rear parking assist is activated.

An illuminated LED in the parking assist button **P** with a triangle symbol indicates that the system is ready to operate.

Indication

The system warns the driver with acoustic signals against potentially hazardous obstacles behind the vehicle in a distance range up to 50 cm while a forward gear is engaged, or up to 1.5 m while reverse gear is engaged.

Depending on which side of the vehicle is closer to an obstacle, you will hear acoustic warning signals in the vehicle on the respective side. The interval between the sounds becomes shorter as the vehicle gets closer to that obstacle. When the distance is less than approx. 30 cm, the sound is continuous.

Additionally, the distance to rear obstacles is displayed by changing distance lines in the Driver Information Centre \rightarrow 82.

The distance indication can be inhibited by vehicle messages with a higher priority. After dismissing the message, distance indication appears again.

Deactivation



Press parking assist button **P** with a triangle symbol to deactivate, the LED in the button extinguishes.

Fault

In the event of a fault or if the system does not work temporarily, e.g. because of high external noise level or other interference factors, the LED in the button flashes for 3 seconds and then extinguishes. A message is indicated in the Driver Information Centre.

Front-rear parking assist

⚠ Warning

The driver bears full responsibility for the parking manoeuvre.

Always check the surrounding area when driving backwards or forwards while using parking assist system.

The front-rear parking assist measures the distance between the vehicle and obstacles in front and behind the vehicle. It informs and warns the driver by giving acoustic signals and display indication.

It uses two different acoustic warning signals for the front and rear monitoring areas, each with a different tone frequency.



The system has four ultrasonic parking sensors in front bumper and three ultrasonic parking sensors in the rear bumper.

Activation

The system is activated automatically at a speed up to 11 km/h.



An illuminated LED in the parking assist button **P+▲** indicates that the system is ready to operate.

If **P+▲** is switched off, the front parking assist is deactivated until the vehicle is switched on again.

If vehicle speed has exceeded 25 km/h beforehand, parking assist will be reactivated when speed drops below 11 km/h.

When the system is deactivated, the LED in the button extinguishes and a message pops-up in the Driver Information Centre.

Indication

The system warns the driver with acoustic signals against potentially hazardous obstacles in front of the vehicle in a distance range up to 80 cm and against potentially hazardous obstacles behind the vehicle in a distance range up to 50 cm while a forward gear is engaged, or up to 1.5 m while reverse gear is engaged.

Depending on which side of the vehicle is closer to an obstacle, you will hear acoustic warning signals in the vehicle on the respective side. The interval between the sounds becomes shorter as the vehicle gets closer to that obstacle. When the distance is less than approx. 30 cm, the sound is continuous.

Additionally, the distance to rear and front obstacles is displayed by changing distance lines in the Driver Information Centre ↷ 82 or, depending on the version, on the Info Display ↷ 85.



The distance indication can be inhibited by vehicle messages with a higher priority. After dismissing the message, distance indication appears again.

Deactivation

The system is deactivated automatically when vehicle speed exceeds 11 km/h.

Manual deactivation is also possible by pressing the parking assist button **P** with a triangle symbol.

When the system is deactivated manually, the LED in the button extinguishes and a message pops-up in the Driver Information Centre.

After a manual deactivation, the front-rear parking assist is activated again if **P** with a triangle symbol is pressed or if reverse gear is engaged.

Fault

In the event of a fault or if the system does not work temporarily, e.g. because of high external noise level or other interference factors, a message pops-up in the Driver Information Centre.

Vehicle messages ↷ 89.

Advanced parking assist**⚠ Warning**

The driver bears full responsibility for accepting the parking slot suggested by the system and the parking manoeuvre.

Always check the surrounding area in all directions when using the advanced parking assist.

The advanced parking assist measures a suitable parking slot while passing, calculates the

trajectory and automatically steers the vehicle into a parallel or perpendicular parking slot.

Instructions are given in the Driver Information Centre ↻ 82 or, depending on the version, on the Info Display ↻ 85, supported by acoustic signals.

The driver must control acceleration, braking and gear shifting, while steering is done automatically.





Advanced parking assist is always combined with front-rear parking assist. Both systems use the same sensors in the front and rear bumper.

The system has six ultrasonic parking sensors in the front bumper and five ultrasonic parking sensors in the rear bumper.

Activation of advanced parking assist

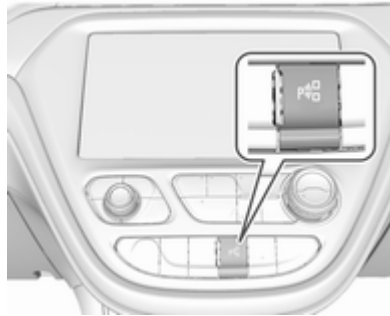
Advanced parking assist can only be activated when driving forwards.



When searching for a parking slot, the system is ready to operate with a short press of .

The system recognises and memorises 10 m for parallel parking slots or 6 m for perpendicular parking slots in the parking assist mode.

The system can only be activated at a speed up to 30 km/h and the system searches for a parking slot at a speed up to 30 km/h.

The maximum allowed parallel distance between the vehicle and a row of parked cars is 1.8 m for parallel parking and 2.5 m for perpendicular parking.

Functionality

Parking slot searching mode, indication in the Info Display



Select parallel or perpendicular parking slot by touching the respective icon on the Info Display.

Select parking side by touching the respective icon on the Info Display.

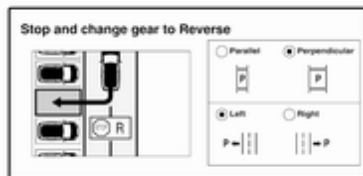

When a slot is detected, a visual feedback on the Info Display and an acoustic signal is given.

If the driver does not stop the vehicle after a parking slot is proposed, the system starts to search for another suitable parking slot.

Park guiding mode

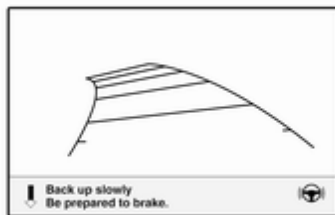

The parking slot suggestion of the system is accepted when the vehicle is stopped by the driver within 10 m for parallel parking slots or 6 m for perpendicular parking slots after the **Stop** message is given. The system calculates the optimal path into the parking slot.

A brief vibration in the steering wheel after engaging reverse gear indicates that the steering is controlled by the system. Then the vehicle is steered into the slot automatically by giving the driver detailed instructions for

braking, accelerating and gear shifting. The driver must keep hands away from the steering wheel.

Always pay attention to the sound of the front-rear parking assist. Continuous sound indicates that the distance to an obstacle is less than approx. 30 cm.

If, for any reason, the driver must take over control of the steering, hold the steering wheel only at the outer edge. Automatic steering is cancelled in this event.

Display indication

The instructions in the Info Display show:

- General hints and warning messages.
- A hint when driving faster than 30 km/h during parking slot searching mode.
- The demand to stop the vehicle, when a parking slot is detected.
- The direction of driving during the parking manoeuvre.
- The demand to shift into reverse gear or drive mode.

- The demand to stop or to drive slowly.
- For some of the instructions a progress bar is shown in the Driver Information Centre.
- The successful completion of the parking manoeuvre indicated by a pop-up symbol and a chime.
- The cancelling of a parking manoeuvre.

Display priorities

Advanced parking assist indication in the Info Display can be inhibited by vehicle messages with a higher priority. After approving the message, advanced parking assist instructions appear again and the parking manoeuvre can be continued.

Deactivation

The system is deactivated by:

- a short press of 
- parking manoeuvre successfully ended

- driving faster than 30 km/h during parking slot search without braking despite message in the Info Display
- driving faster than 8 km/h during parking guidance
- driver interference on steering wheel detected
- exceeding number of maximum gear changes: eight cycles when parallel parking or five cycles when perpendicular parking
- switching off the vehicle

Deactivation by the driver or by the system during manoeuvring will be indicated by a message on the display. Additionally, an acoustic signal sounds.

Fault

A message appears when:

- There is a fault in the system.
- The driver did not successfully complete the parking manoeuvre.
- The system is not operational.
- Any of the deactivation reasons described above apply.

If an object is detected during parking instructions, **Stop** is indicated on the display. Removing the object will resume the parking manoeuvre. If the object is not removed, the system will be deactivated. A long press of  will activate the system and search for a new parking slot.

Basic notes on parking assist systems

Warning

Under certain circumstances, various reflective surfaces on objects or clothing as well as external noise sources may cause the system to fail to detect obstacles.

Special attention must be paid to low obstacles which can damage the lower part of the bumper.

Caution

Performance of the system can be reduced when sensors are covered, e.g. by ice or snow.

Performance of the parking assist system can be reduced due to heavy loading.

Special conditions apply if there are taller vehicles in the vicinity (e.g. off-road vehicles, mini vans, vans). Object identification and correct distance indication in the upper part of these vehicles cannot be guaranteed.

Objects with a very small reflection cross-section, e.g. objects of narrow size or soft materials, may not be detected by the system.

Parking assist systems do not detect objects outside the detection range.

Note

It is possible that the sensor detects a non-existing object caused by echo disturbance from external

acoustic noise or mechanical misalignments (sporadic false warnings may occur).

Make sure that the front number plate is properly mounted, vertically and horizontally centred and the sensors are firmly in place. The performance of the parking assist could be reduced if the number plate is bent or a number plate holder is used.

Advanced parking assist system may not respond to changes in the available parking space after initiating a parking manoeuvre. The system may recognize an entry, a gateway, a courtyard or even a crossing as a parking slot. After selecting reverse gear the system will start a parking manoeuvre. Take care regarding the availability of the suggested parking slot.

Low curbs and surface irregularities, e.g. on construction zones, are not detected by the system. The driver accepts responsibility.

Note

Each new vehicle requires a calibration. For optimal parking guidance, a driving distance of at least 10 km, including a number of bends, is required.

Side blind zone assistant

The side blind zone assistant detects and reports objects on either side of the vehicle, within a specified "blind zone". The system displays a visual alert in each exterior mirror, when detecting objects that may not be visible in the interior and exterior mirrors.

The radar distance sensors are located in the rear bumper.



Warning

Side blind zone assistant does not replace driver vision.

The system does not detect:

- vehicles outside the side blind zones which may be rapidly approaching
- pedestrians, cyclists or animals

Before changing a lane, always check all mirrors, look over the shoulder and use the turn lights.

When the system detects a vehicle in the side blind zone while driving forwards, either while passing a vehicle or being passed, a yellow warning symbol  will illuminate in the relevant exterior mirror. If the driver then activates the turn light, the warning symbol  starts flashing yellow as a warning not to change lanes.

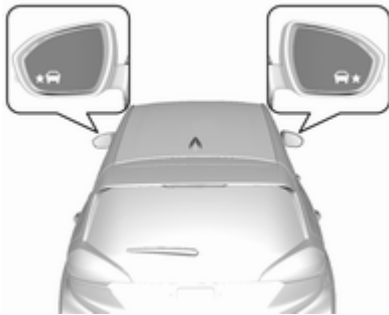

When the vehicle is started, both exterior mirror displays will briefly illuminate to indicate that the system is operating.

The system can be activated or deactivated in the Info Display.

Vehicle personalisation ⇨ 90.

Side blind zone assistant will be deactivated when Lane change alert is deactivated. Deactivation is indicated by a message in the Driver Information Centre.

Detection zones

The detection zones start at the rear bumper and extend approx. 3 m rearwards and to the sides. The height of the zone is approx. between 0.5 m and 2 m off the ground.

Side blind zone assistant is designed to ignore stationary objects, e.g. guardrails, posts, curbs, walls and beams. Parked vehicles or oncoming vehicles are not detected.

Fault

Occasional false alerts can occur under normal circumstances and will increase in wet conditions.

Side blind zone assistant does not operate when the left or right corners of the rear bumper are covered with mud, dirt, snow, ice, slush, or in heavy rainstorms.

Cleaning instructions ⇨ 243.

In the event of a fault in the system or if the system does not work due to temporary conditions, a message is displayed in the Driver Information Centre. Seek the assistance of a workshop.

Lane change alert

Additional to the side blind zone assistant ⇨ 180, lane change alert recognises rapidly approaching vehicles from behind on parallel lanes next to your vehicle.

If the vehicle is equipped with lane change alert, side blind zone assistant is always included.



The system alerts visually in each exterior mirror when detecting rapidly approaching vehicles from behind.

The radar distance sensors are located in the rear bumper.

⚠ Warning

Lane change alert does not replace driver vision.

Before changing a lane, always check all mirrors, look over the shoulder and use the turn light.

When the system detects an approaching vehicle from behind which drives considerably faster, the yellow warning symbol  will illuminate in the relevant exterior mirror. If the driver then activates the turn light, the warning symbol  starts flashing yellow as a warning not to change lanes.

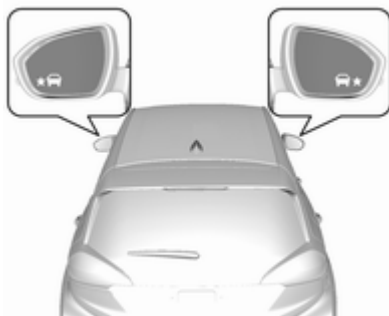

When the vehicle is started, both exterior mirror displays will briefly come on to indicate that the system is operating.

Detection zones

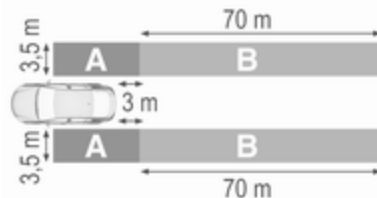

The system sensors cover a zone of approx. 3.5 m parallel on both vehicle sides and approx. 3 m rearwards on side blind zone assistant (A) and approx. 70 m rearwards on lane change alert (B) on parallel lanes. The zones start at each exterior mirror. The height of the zone is approx. between 0.5 m and 2 m off the ground.

Deactivation

Activation or deactivation of the lane change alert can be set in the vehicle personalisation menu in the Info Display.

Vehicle personalisation ⇨ 90.

Info Display ⇨ 85.

Deactivation is indicated by a message in the Driver Information Centre.

Note

Each new vehicle requires a calibration. For optimal performance, drive as soon as possible on a straight highway road with roadside objects, e.g. guardrails and barriers for some distance.

System limitations

Occasional false alerts can occur under normal circumstances or in sharp curves. The system can temporarily alert of objects in the blind zone at specific weather conditions (rain, hail etc). Driving on a wet road or in the transitions from a dry area to a wet area can cause the system to light up, as water splash can be interpreted as an object. Otherwise ★🚗 may illuminate due to guardrails, signs, trees, shrubs or other immobile objects. This is normal operation and the system does not need a service.

The system may not operate properly when:

- ice, snow, mud, or anything else covers the sensors
- driving in heavy rainstorms
- the vehicle had an accident
- there are extreme temperature changes

In the event of a fault in the system or if the system does not work due to temporary conditions, a message is displayed in the Driver Information Centre. Seek the assistance of a workshop.

Panoramic view system

The panoramic view system vision displays an image of the area surrounding the vehicle, along with the front or rear camera views in the centre console.

The system uses four cameras:

- rear camera, installed above the license plate
- front camera, installed in the grille or near the front emblem
- side cameras, located at the bottom of both exterior mirrors

Warning

The surround vision cameras have blind spots and will not display all objects near the corners of the vehicle. Folding side mirrors that are out of position will not display the surrounding view correctly. Always check around the vehicle when parking or reversing.

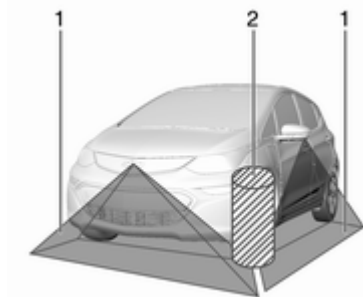

1. Area displayed by the panoramic view system
2. Area not shown

Front vision camera



A view of the area in front of the vehicle may be displayed in the Info Display. The front view is shown after shifting from **R** to **D** and when the vehicle is moving forward slower than 8 km/h.

Warning

The camera(s) do not display children, pedestrians, bicyclists, crossing traffic, animals, or any other object outside of the cameras' field of view, below the bumper, or under the vehicle.

Shown distances may be different from actual distances. Do not drive or park the vehicle using only these camera(s). Always check behind and around the vehicle before driving. Failure to use proper care may result in injury, death, or vehicle damage.

The system also works when the surrounding is dark, but performance may be restricted.

Rear view camera

The rear view camera assists the driver when reversing by displaying a view of the area behind the vehicle.

The view of the camera is displayed in the Info Display.

Warning

The rear view camera does not replace driver vision. Note that objects that are outside the camera's field of view and the

parking assist sensors, e.g. below the bumper or underneath the vehicle, are not displayed.

Do not reverse or park the vehicle using only the rear view camera.

Always check the surrounding of the vehicle before driving.

Activation

Rear view camera is automatically activated when reverse gear is engaged.

Functionality



The camera is mounted between the number plate lights and has a viewing angle of 130°.

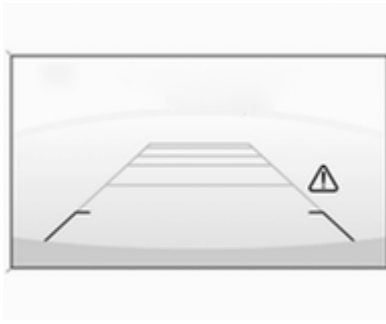

The area displayed by the camera is limited. The distance of the image that appears on the display differs from the actual distance.

Guiding lines

Dynamic guiding lines are horizontal lines at 1 m intervals projected onto the picture to define the distance to displayed objects.

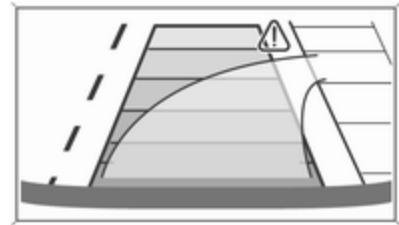

Trajectory lane of the vehicle is shown in accordance with the steering angle.

Warning symbols

Warning symbols are indicated as triangles \triangle on the picture, which show obstacles detected by the rear sensors of the advanced parking assist.

Additionally, \triangle appears on the top line of the Info Display with the warning to check the vehicle surroundings.

Display settings

Brightness and contrast can be set by touching the touch screen display when rear view camera is active.

Deactivation

The camera is switched off when a certain forward speed is exceeded or if reverse gear is not engaged for approx. 15 seconds. Rear view camera can be manually deactivated in the vehicle personalisation menu in the Info Display. Select the relevant setting in **Settings** ▶ **Vehicle settings**.

Deactivation of guiding lines and warning symbols

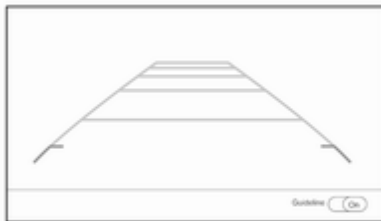

Activation or deactivation of the visual guiding lines and the warning symbols can be changed in the **Settings** menu in the Info Display. Select the relevant setting in **Settings** ▶ **Rear camera**.

Info Display ⇨ 85.

Vehicle personalisation ⇨ 90.

Fault

Fault messages are displayed with a  on the Driver Information Centre.

The rear view camera may not operate properly when:

- The surrounding is dark.
- The sun or the beam of headlights is shining directly into the camera lens.
- Ice, snow, mud, or anything else covers the camera lens. Clean the lens, rinse it with water, and wipe it with a soft cloth.
- The vehicle had a rear end accident.
- There are extreme temperature changes.

Rear cross traffic alert

Additional to the rear view camera ⇨ 184, rear cross traffic alert warns of cross traffic from left or right side when reversing. When cross traffic is recognised and the rear view camera is activated, a warning triangle with a direction arrow  appears on the Info Display, showing the direction of the traffic. Furthermore, three beeps will sound from the speaker on the respective side.

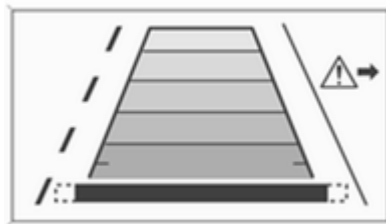

The radar distance sensors are located sideways in the rear bumper.

⚠ Warning

The rear cross traffic alert does not replace driver vision. Note that objects that are outside sensors, e.g. below the bumper or underneath the vehicle, are not displayed.

Pedestrians, children or animals are not detected. Do not reverse the vehicle by only looking at the Info Display and check the surrounding behind and around the vehicle before reversing.

Activation

Rear cross traffic alert is automatically activated together with the rear view camera when reverse gear is engaged.

Detection zones

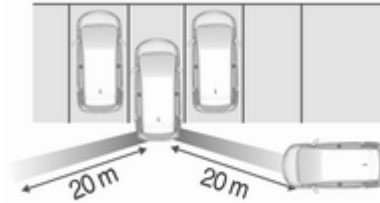

The system sensors cover a zone of approx. 20 m to the left or right side behind the vehicle.

Deactivation

Rear cross traffic alert is deactivated together with the rear view camera when a certain forward speed is exceeded or if reverse gear is not engaged for approx. 10 seconds.

Activation or deactivation of the rear cross traffic alert can be set in the vehicle personalisation menu in the Info Display.

Select the relevant setting in **Settings** ▶ **Vehicle settings** in the Info Display.

Info Display ⇨ 85.

Vehicle personalisation ⇨ 90.

Fault

The system may not operate properly when:

- Ice, snow, mud, or anything else covers the sensors.
- The vehicle had a rear end accident.
- There are extreme temperature changes.

Traffic sign assistant

Functionality

Traffic sign assistant detects designated traffic signs via a front camera and displays them in the Driver Information Centre.



Traffic signs, which will be detected, are:

Limit and no passing signs

- speed limit
- no passing
- end of speed limit
- end of no passing

Road signs

Beginning and end of:

- city regions (country-specific)
- motorways
- A-roads
- play streets

Add on signs

- additional hints to traffic signs
- restriction of trailer towing
- tractor constraints
- wet warning
- ice warning
- time constraints
- distance constraints
- direction arrows

Speed limit signs and no passing signs are displayed in the Driver Information Centre until the next speed limit sign or end of speed limit is detected or up to a defined sign timeout.



Indication of multiple signs on the display is possible.



An exclamation mark in a frame indicates that there is an additional sign detected which cannot be clearly identified by the system.

The system performance depends on the lighting conditions.

Display indication

Information about the currently valid traffic signs is available on the designated traffic sign assistant page in the Driver Information Centre.

Additionally, the currently valid speed limit is displayed permanently in the lower line of the Driver Information Centre. In case a speed limit with add on sign is available, a + symbol is displayed in this area.



Choose **Vehicle info** via right steering wheel buttons and press Δ or ∇ to select traffic sign assistant page \rightarrow 82.

When another page on the Driver Information Centre menu was selected and then traffic sign assistant page is chosen again, the last recognised traffic sign will be displayed.

Alert function



Once activated, speed limit and no passing signs are displayed as pop-up alerts in the Driver Information Centre.

The alert function can be activated or deactivated by pressing \checkmark on the steering wheel.

System reset

The content of the traffic sign display can be cleared in the settings menu of the traffic sign assistant page by selecting **Reset** and confirm by pressing \checkmark on the steering wheel controls.

Alternatively, \checkmark can be pressed for 3 seconds to clear the content of the page.



In some cases, traffic sign assistant is cleared up automatically by the system.

Clearing of traffic signs

There are different scenarios that lead to clearing the currently displayed traffic signs. After clearing, the "Default Sign" or a sign from navigation map data is displayed in the Driver Information Centre.

Reasons for signs being cleared:

- A predefined distance was driven or time has elapsed (differs for each sign type)
- Vehicle drives through a turn
- If speed drops below 52 km/h (city entry detection)

Fault

Traffic sign assistant may not operate correctly if:

- The area of the windscreen, where the front camera is located, is not clean or affected by foreign items, e.g. stickers.
- Traffic signs are completely or partially covered or difficult to discern.
- There are adverse environmental conditions, e.g. heavy rain, snow, direct sunlight or shadows.
- Traffic signs are incorrectly mounted or damaged.
- Traffic signs do not comply with the Vienna Convention on Road Signs and Signals.

Caution

The system is intended to help the driver within a defined speed range to discern certain traffic signs. Do not ignore traffic signs which are not displayed by the system.

The system does not discern any other than the conventional traffic signs that might give or end a speed limit.

Do not let this special feature tempt you into taking risks when driving.

Always adapt speed to the road conditions.

The driver assistance systems do not relieve the driver from full responsibility for vehicle operation.

Lane keep assist

Lane keep assist helps to avoid crashes due to unintentional lane departures. The front camera observes the lane markings between which the vehicle is driving. If the vehicle approaches a lane marking, the steering wheel is gently turned to position the vehicle back into the lane.

Override the system by turning the steering wheel.

When crossing a lane marking significantly, lane keep assist starts a visual and acoustic warning.

Unintended lane departure is assumed:

- without using turn light
- using the turn light in the opposite direction of the lane departure
- without braking
- without acceleration
- without active steering

Note

The system is switched off during detection of ambiguous lane markings, e.g. in construction areas.

Note

The system may be switched off if it detects lanes which are too narrow, too wide or too curved.

Activation

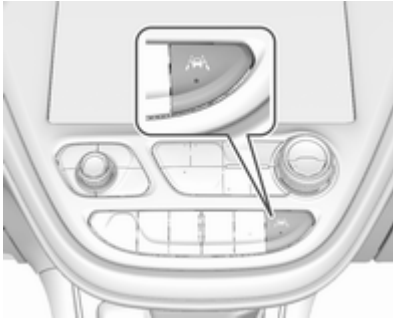



The lane keep assist is activated by pressing . The LED in the button illuminates to indicate that the system is switched on.



When the control indicator  in the instrument cluster illuminates green, the system is ready to assist.

The system is operational at vehicle speeds above 60 km/h and if lane markings are available.

The system gently turns the steering wheel and the control indicator  changes to yellow, if the vehicle approaches a detected lane marking without using the turn light in that direction.

The system alerts by flashing  together with three chimes, from the respective direction, if the lane is departed significantly.

The system is only operable when a lane marking is detected.

If the system only detects lane markings on one side of the road, it will only assist for this side.

Lane keep assist detects hands-free driving. In this case a message in the Driver Information Centre pops-up and a chime sounds as long as lane keep assist detects hands-free driving.

Always take the steering wheel while driving. Both the driving manner and the road condition may affect the

timing of alert and the occurrence of alert. Move the steering wheel to stop the alert.

Deactivation

The system is deactivated by pressing . The LED in the button extinguishes.

The system is reactivated the next time the vehicle is switched on.

Fault

The system performance may be affected by:

- windscreen not clean or affected by foreign items, e.g. stickers
- close vehicles ahead
- banked roads
- winding or hilly roads
- road edges
- roads with poor lane markings
- sudden lighting changes
- adverse environmental conditions e.g. heavy rain or snow
- vehicle modifications, e.g. tyres

Switch off the system if the system is disturbed by tar marks, shadows, road cracks, temporary or construction lane markings, or other road imperfections.

Warning

Always keep your attention on the road and maintain proper vehicle position within the lane, otherwise vehicle damage, injury or death could occur.

The system does not detect pedestrians, cyclists or animals on the road. Steer the vehicle manually to avoid injuries and deaths.

Lane keep assist does not continuously steer the vehicle.

The system may not keep the vehicle in the lane or give an alert, even if a lane marking is detected.

The steering of the lane keep assist may not be sufficient to avoid a lane departure.

The system may not detect hands-off driving due to external influences (road condition and surface, weather etc). The driver has full responsibility to control the vehicle and is always required to keep the hands on the steering wheel while driving.

Using the system while driving on slippery roads could cause loss of control of the vehicle and a crash. Switch off the system.

Charging

This section explains the process of charging the vehicle's high voltage battery. Do not allow the vehicle to remain in places with extremes of temperature for long periods without being driven or plugged in.

It is recommended to keep the vehicle plugged in, even if fully charged, to keep the high voltage battery temperature ready for the next drive.

The vehicle must be plugged in when the temperatures are below -25 °C, to operate properly and to maximise high voltage battery life.

However, we recommend plugging in the vehicle when temperatures drop below 0 °C or raise above 32 °C.

When using the portable charge cord, it will take approximately 33 hours to charge the vehicle with the 10 A setting.

When using a 230 V charging station, it will take approximately 10 hours to charge the vehicle with the 32 A setting.

Charge times will vary based on high voltage battery condition and outside temperature. There are three ways to programme how the vehicle is charged.

Programmable charging ⇨ 196.

The charging system may run fans and pumps resulting in noises coming from the vehicle while it is turned off. Additional clicking sounds may be caused by the electrical devices used while charging.

While the charge cord is plugged into the vehicle, the vehicle cannot be driven.

When to charge

When the high voltage battery is getting low, charging messages may be displayed.

The **Charge vehicle soon** message indicates that the driving range is low and the vehicle needs to be charged soon. As the charge level drops, the **Propulsion power is reduced** message is displayed and the accelerator pedal response is reduced. In addition, the remaining

range value will change to **Low** indicating the vehicle should be charged immediately.

When the energy is fully depleted, the **Out of power. Charge vehicle now** message is displayed and the vehicle slows to a stop. Brake and steering assist will still operate. Once the vehicle has stopped, switch off the vehicle.

AC (alternating current) charging

Start charging

A portable charge cord used to charge the vehicle high voltage battery is stored under the rear floor storage cover in the load compartment.

1. Shift into **P** (Park) and switch off the vehicle.



2. Push the rearward edge of the charge port door in and release to open the door.

In cold weather conditions, ice may form around the charge port door. Remove ice from the area before attempting to open or close the charge port door.



3. Open the tailgate. Lift the rear floor storage cover and remove the charge cord.

4. Plug the charge cord into the electrical outlet.

Electrical requirements ⇨ 208.

Verify the charge cord status.

Charge cord ⇨ 205.

Select the appropriate charge level.

See "Charge limit selection" in Programmable charging ⇨ 196.



5. Plug in the vehicle plug of the charge cord into the charge port on the vehicle. Verify that the charging status indicator illuminates on top of the instrument panel and an audible beep occurs.

Charging status ⇨ 203.

6. Once charging, the vehicle plug will be locked to the charge port and cannot be disconnected while charging is active.

Stop charging

1. To stop charging, when inside the vehicle, use the **Stop** button on the **Charging** screen.

See "Temporary charge mode override and cancel" in Programmable charging ⇨ 196.

Additionally, the stop charge button on the electronic key may also be used. Press and hold  on the electronic key. This will also unlock the vehicle plug.



2. Unplug the vehicle plug of the charge cord from the vehicle.

3. Close the charge port door by pressing firmly in the centre until it engages.

4. Unplug the charge cord from the electrical outlet.

5. Place the charge cord into the storage compartment.

DC (direct current) charging

Check the charging station DC vehicle plug for compatibility with the DC charge port on this vehicle. When recharging at a DC fast charge station, the power cable connected to the vehicle must be less than 10 m in length.

Follow the steps listed on the charging station to perform a DC vehicle charge.

If for any reason DC charging does not begin or is interrupted, check the DC charge station display for messages. Unplug to restart the DC charge process.

Start charging

1. Make sure the vehicle is parked.
2. Push the rearward edge of the charge port door and release to open the door.

In cold weather conditions, ice may form around the charge port door. The charge port door may not open on the first attempt. Remove ice from the area and

repeat attempt to open the charge port door.

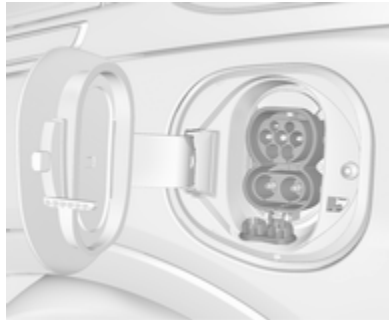

3. Open the DC dust cover. Plug in the DC vehicle plug into the DC charge port on the vehicle. Make sure that the DC vehicle plug is fully connected to the DC charge port. If it is not properly seated then the charge may not occur. Proper plug connection can be checked by information on the Driver Information Centre.
4. Follow the steps listed on the charging station to start charging. The electric parking brake will automatically apply once the charge process has been started.

5. Once charging, the DC vehicle plug will be locked to the DC charge port and cannot be disconnected while charging is active.
6. Verify that the charging status indicator illuminates on top of the instrument panel and a horn chirp occurs.
Charging status ⇨ 203.

Caution

Do not attempt to disconnect the DC vehicle plug while charging is active. This action may damage vehicle or charging station hardware.

Stop charging

Controls on the charging station can be used to stop the charge process at any time. Or press and hold  on the electronic key. This will also unlock the vehicle plug.

To stop charging when inside the vehicle, you may use the **Stop** button on the **Charging** screen.

Programmable charging ⇨ 196.

There is also an available mobile app with several charging functions.

Smartphone remote function ⇨ 27.

Automatic power supply cut-off

When the vehicle no longer needs to use power from the charging station, the charging process will be stopped. Use the electronic key to unlock the DC vehicle plug.

Energy can still be consumed from the charging station when the vehicle's displays and indicators show that the high voltage battery is fully charged. This is to ensure the high voltage battery is in optimal temperature operating range to maximise vehicle range.

Programmable charging ⇨ 196.

End charging

1. Wait until the charging process has been fully stopped, the vehicle plug is unlocked and the charging status indicator is solid green or off.
2. Unplug the DC vehicle plug from the DC charge port on the vehicle and close the dust cover.

3. Close the charge port door by pressing firmly in the centre to latch properly.
4. Manually disengage the electric parking brake before driving the vehicle.
5. To start another DC charge, remove the DC vehicle plug and reconnect.

Programmable charging

Programmable charge modes

To view the current charge mode status on the Info Display, touch **Energy** and then **Charging**.

The charge start and charge complete time estimations are also displayed on the screen. These estimations are most accurate when the vehicle is plugged in and in moderate temperature conditions. Also, to get an accurate time estimate, the vehicle uses an internal clock for programmable charging, not the clock in the instrument panel.

Charge mode selection

Touch **Energy** and then **Charging** and select the desired charging mode.

Immediate



The vehicle starts charging as soon as it is connected to an electrical outlet.

Select the **Charge limit**, see below.

Departure

The vehicle estimates the charging start time considering the programmed departure time for the current day of the week. Charging begins at the start time and is

complete by the departure time only if sufficient time is allowed after the charge cord is plugged in.

Select the **Priority charging to On or Off** (Priority charging will immediately charge the vehicle to a predefined level).

Departure time entry

The departure charge mode allows for the departure time to be entered to match your personal schedule.

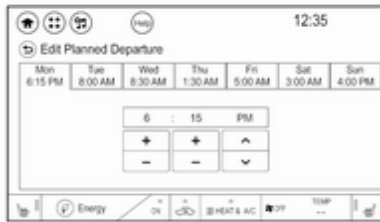

1. With **Departure** charge mode selected, touch **Edit**.

2. The current programmed departure time is displayed on the tab with the day of the week. Select the tab for the day of the week that needs to be edited.
3. Touch **+** or **-** to change the hours and minutes.
4. Touch **∨** or **∧** to change **AM** or **PM**.
5. Touch **↩** to exit the screen.

Note

- Charging begins at the start time and is completed by departure time only if sufficient time is allowed after the charge cord is plugged in.
- The vehicle uses an internal clock for programmable charging, not the clock in the Info Display.

Charging mode error

If a charging problem has occurred, the error message is displayed. In this case, please try restarting the vehicle or contact a workshop.



Charge limit selection



The charge limit setting allows the vehicle's charge limit to be selected so it matches the capability of the charging location. If the vehicle consistently stops charging after plugging in, or if a circuit breaker continues to trip, reducing to a lower charge limit setting may resolve the issue.

The charge limit setting should be configured to match the electrical current rating for the electrical outlet that the charge cord is connected to. On the **Charge mode** screen, toggle the **Charge limit** selection between:

- 10 A
- 6 A

The charge limit setting must be updated prior to the vehicle being charged and the charge limit setting will reset to a default value when the vehicle is shifted from P.

⚠ Warning

If the capacity of the electrical circuit or AC socket is not known, only use the lowest charge level

until the circuit capacity has been inspected by a qualified electrician. Using a charge level that exceeds either the electrical circuit or the AC outlet capacity may start a fire or damage the electrical circuit.

Electrical requirements ⇨ 208.

Electric rate preference

The vehicle estimates the charging start time based on the utility rate schedule, utility rate preference, and the programmed departure time for the current day of the week. The vehicle will charge during the least expensive rate periods to achieve a full high voltage battery charge by the departure time. Electrical rate information from the utility company for the charging location is required for this mode.

From the **Charge mode** screen with **Departure** charge mode selected, touch **More** to select the **Electric rate preference**.

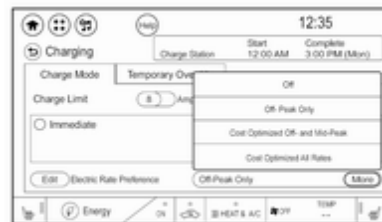

Touch one of the following options to select the **Electric rate preference**:

- **Off**: Delayed charging based on departure.
- **Off-peak only**: Charge during off-peak rates.
- **Cost optimised off-peak & mid-peak**: Charge during mid-peak and off-peak rates.
- **Cost optimised all rates**: Charge during peak, mid-peak, and off-peak rates.

Charging begins at the start time and is complete by the departure time only if sufficient time is allowed after the charge cord is plugged in. For

example, if the vehicle is plugged in for only 1 hour prior to the departure time, and the high voltage battery is completely discharged, the vehicle will not be fully charged by the departure time regardless of the rate selection.

Also, if the selected electric rate settings result in a very long charge completion time, the vehicle will start charging immediately upon plug-in. For example, if the electric rate table is set up with all peak rates and the rate preference is to charge during off-peak rates only, then the vehicle will start charging immediately upon plug-in.

Electric rate schedule

From the **Charging** mode screen with **Departure** charge mode selected, touch **Edit** in the **Electric rate preference**.



Select one of the following for the **Charge completion** option:

- **Earliest possible**
- **Latest possible**

Electric rates, or cost per unit, may vary based on time, weekday / weekend, and season. During the day when the demand for electricity is high, the rates are usually higher and called peak rates. At night when the demand for electricity is low, the rates are usually lower and called off-peak rates. In some areas, a mid-peak rate is offered.

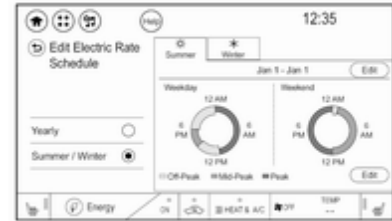

Touch **Edit electric rate schedule** from the **Electric rate Schedule** screen and select the desired schedule.

- **Yearly**
- **Summer / Winter**

Summer / Winter schedule start date entering

With **Summer / Winter** as the preferred rate schedule, touch **Edit** on the **Summer** tab next to the dates.

1. Touch **+** or **-** to change the month and day for the start of Summer.
2. Select the **Winter** tab.

3. Touch **+** or **-** to change the month and day for the start of Winter.
4. Touch **↩** to exit the screen.

Electric rate schedule editing

Electric rate information from the utility company for the charging location is required.

1. Touch **Edit electric rate schedule** from the **Electric rate Schedule** screen and select the desired schedule.

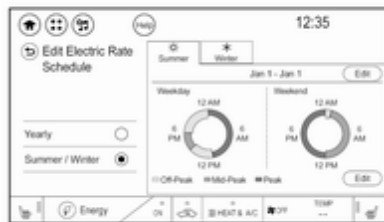

2. Touch **Edit** in the lower right corner of the screen to edit the electric rate schedule.
Both weekday and weekend schedules must be set. The rate

schedule only applies for a 24-hour period, starting at 12 AM and ending at 12 AM. There can be five rate changes for each day; not all must be used.

3. Touch **Set** next to the row to be edited.



4. Select **Peak**, **Mid-peak**, or **Off-peak**. Use **+** or **-** to enter the time, and **∨** or **∧** to change AM or PM.

The finish times must be consecutive. If a finish time does not follow a start time, an error message displays.

5. Touch **OK**.

Priority charging

The priority charging feature will work when the **Departure** charge mode is selected. This feature is designed to ensure that the high voltage battery pack has a minimal amount of energy prior to delaying a charge. Upon completion of priority charging the vehicle will return to normal programmable charging operation.

The feature can be enabled or disabled by selecting **On** or **Off** from the **Charge mode** screen when the **Departure** charge mode is selected. When enabled, priority charging will only prevent programmable charging while the high voltage battery is recharged from a depleted state to a 40% state of charge.

Temporary charge mode override and cancel

To temporarily override a delayed charge event, unplug the charge cord from the charge port and then plug it back in within 5 seconds. A single audible chirp will sound and charging will begin immediately.

To cancel a temporary override, unplug the charge cord, wait for 10 seconds, and then plug the charge cord back in. A double audible chirp will sound and charging will be delayed.

Temporary override of a delayed charge mode

Programmed delayed charge modes can be temporarily overridden to an immediate charge mode for one charge cycle. Also, the next planned departure time can be temporarily overridden for one charge cycle. In addition to the in-vehicle overrides via the programmable charging screens, there are other ways to temporarily override a delayed charge mode.

Programmed charging override
↗ 203.

The **Temporary override** provides the ability to set temporary charge items for the next charge cycle.

Touch the **Temporary override** tab on the **Charging** screen.



Select:

- **Immediate:** Charge immediately at plug in.
- **Temporary Departure:** Set the temporary departure time.
- **Off:** Cancel temporary charge mode.

To override or cancel an active charging cycle, touch **Stop** on the **Charging** screen.

Target charge level

This mode allows the charging range for the vehicle to be set based on what is needed. When at a public pay station and a full charge is not

needed, the target charge level can be set to only get as much range as needed.

If driving on a hill, the target charge level can be set to stop the charge before the battery is full to allow space for energy from regenerative braking when going down a hill.

There is a minimum target charge level. Once this level is reached, – will be grayed out.

Touch **Target Charge Level** on the charging screen.

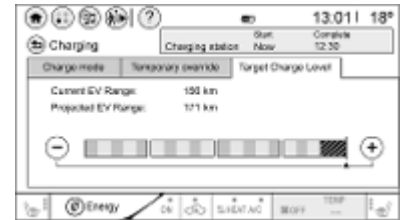

Touch + or – to increase or decrease the charge level.



A reminder will be displayed on the instrument cluster to show target charge level set.

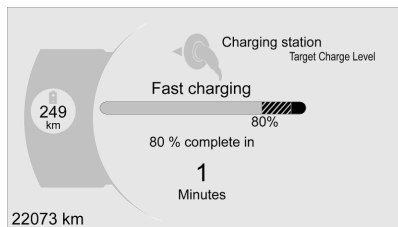

If the target charge level is higher than 80%, fast charging on the instrument cluster will show a solid line to 80%, a shaded line up to the target charge level, and the time to complete 80%.

If the target charge level is less than 80%, fast charging on the instrument cluster will show a shaded line up to the target charge level and the time to complete.

Target charge level defaults to 100% if the 12 V vehicle battery becomes discharged.

Location based charging

With **Location-based charging** enabled, the **Charge mode** and **Charge limit preference** are saved and set back to the customer's preference every time the vehicle is returned to the saved **Home** location. When the vehicle is not at the saved **Home** location, then the vehicle will default to the lower limit of **Charge limit preference** and the **Charge mode** will be set to **Immediate**.

When **Location-based charging** is **On** and the vehicle is away from the saved **Home** location, then the selection for the charge mode will be disabled and the selection will be greyed out.

After 90 days, a notification will display and the **Charge limit preference** will need to be reset for the next 90 days. Important information about portable electric vehicle charging ↷ 205.

When the GPS location is not available, dashes will be displayed and location based charging will be disabled until the GPS is restored.

To use location based charging, a **Home** location must first be stored.

To store a **Home** location:

1. From the **Energy** home screen, touch **Charging Options**.
2. Touch **Location-based charging**.
3. Touch **Set home location** ○.
4. Touch **OK**.
5. Touch **On** to enable **Location-based charging**.

To change the stored **Home** location:

1. Touch **Update Home Location** ○ on the **Location-based charging** screen.
2. Touch **Update**, then **OK** to set the new home location.

- Touch **Cancel** to make no changes.
- Touch **Remove** to clear the location and turn location based charging off.

Charging interrupted or overridden pop-up

The **Charging override / interruption occurred** pop-up will appear if any of the following conditions occur:

- The charging settings have been modified via OnStar through the website or the mobile app. For example, the departure time tables, the rate tables, or the charge mode were updated using the customer website (available in select regions).
- There was an unintended loss of AC power during the plug-in charge event. For example, there was a power outage or the charge cord was unplugged from the wall.

Programmable charging disabled



When the programmable charging system is disabled, the **Unable to charge** screen will be displayed.

Programmed charging override

To temporarily override a delayed charge event, unplug the charge cord from the charge port and then plug it back in within 5 seconds. A single horn chirp will sound and charging will begin immediately.

To cancel a temporary override, unplug the charge cord, wait for 10 seconds, and then plug the charge cord back in. A double horn chirp will sound and charging will be delayed. Programmable charging ↗ 196.

Charging status

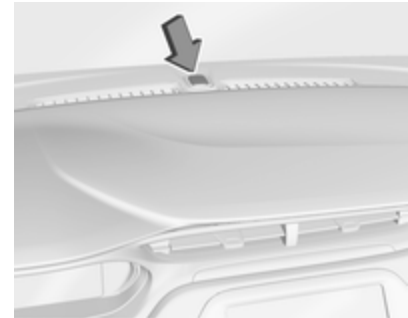

The vehicle has a charging status indicator at the centre of the instrument panel near the windscreen. When the vehicle is plugged in and the vehicle power is off, the charging status indicator indicates the following:

- Short flashing green – One horn chirp: Vehicle is plugged in. High voltage battery is not fully charged. High voltage battery is charging. Flash rate increases from one to four flashes as the high voltage battery charges.
one flash: 0–25% charge
two flashes: 25–50% charge
three flashes: 50–75% charge
four flashes: 75–100% charge
- Short flashing green – Two audible beeps: Vehicle is charging but will delay by programmable charging at least once before the charge is complete. Flash rate increases from one to four flashes as the high voltage battery charges.
- Short flashing green – Four audible beeps: Insufficient time to fully charge by departure time due to the selected rate preference. To increase the high voltage battery state of charge at the departure time perform a delayed charging override.
Programmable charging ⇨ 196.

- Long flashing green – Two horn chirps: Charging is delayed by programmable charging. Charging will begin later.
- Solid green – No horn chirps: Charging is complete.
- Solid yellow – No horn chirp: Vehicle is plugged in. It is normal for the charging status indicator to turn yellow for a few seconds after plugging in a compatible charge cord. The solid yellow may remain illuminated depending on the vehicle and if there is a total utility interruption. This may also indicate that the charging system has detected a fault and will not charge the high voltage battery.
- No light signal (upon plug-in) – No horn chirps: Charge cord connection should be checked.
- No light signal (after indication of green or yellow charging status indicator) – No horn chirps: Charge cord connection should be checked. If connection is correct, this may be due to a power failure and charging will

begin later. This may also occur if the vehicle has detected a high voltage charging system fault.

- No light signal – Three horn chirps: Charge port door is open.
- No light signal – Horn chirps repeatedly: The power supply was interrupted before the charging process could be completed. Repeated chirps will stop if power is restored within 90 seconds.

To stop the alert, unplug the charge cord or press  on the electronic key.

The charge power loss alert can be disabled in the Info Display.

Vehicle personalisation ⇨ 90.

The system may be thermally conditioning the high voltage battery during any of the states mentioned above, requiring electric energy to be transferred to the vehicle.

If the vehicle is plugged in and vehicle power is on, the charging status indicator will flash or illuminate solid green, depending on the charge level.

If the vehicle is plugged in and the charging status indicator is off, a charging fault has been detected.

Charge cord

Danger

There is a risk of electric shock that may cause personal injury or death.

Do not use the charge cord if any part of the charge cord is damaged.

Do not open or remove the charge cord cover.

Service by qualified personnel only. Connect the charge cord to a properly grounded outlet with cords that are not damaged.

A portable charge cord used to charge the vehicle high voltage battery is stored under the rear floor storage cover in the load compartment ↗ 192.

Important information about portable electric vehicle charging

- Charging an electric vehicle can stress a building's electrical system more than a typical household appliance.
- Before you plug in to any electrical outlet, have a qualified electrician inspect and verify the electrical system (electrical outlet, wiring, junctions and protection devices) for heavy-duty service at a 10 A continuous load.
- Electrical outlets may wear out with normal usage or be damaged over time, making them unsuitable for electric vehicle charging.
- Check the electrical outlet / plug while charging and discontinue use if the electrical outlet / plug is hot, then have the electrical outlet serviced by a qualified electrician.

- When outdoors, plug into an electrical outlet that is weather-proof while in use.
- Mount the charging cord to reduce strain on the electrical outlet / plug.

Warning

Improper use of portable electric vehicle charge cords may cause a fire, electrical shock, or burns, and may result in damage to property, serious injury, or death.

- Do not use extension cords, multi-outlet power strips, splitters, grounding adaptors, surge protectors, or similar devices.
- Do not use an electrical socket that is worn or damaged, or one that will not hold the plug firmly in place.
- Do not use an electrical socket that is not properly grounded.
- Do not use an electrical socket that is on a circuit with other electrical loads.

⚠ Warning

Read all the safety warnings and instructions before using this product. Failure to follow the warnings and the instructions may result in electric shock, fire, and / or serious injury.

Never leave children unattended near the vehicle while the vehicle is charging and never allow children to play with the charge cord.

If the plug provided does not fit the electrical outlet, do not modify the plug. Arrange for a qualified electrician to inspect the electrical outlet.

Do not put fingers into the electric vehicle connector.

⚠ Warning

To reduce the risk of fire, installations shall comply with the requirements of the standard International Electrotechnical

Commission IEC 60364 on electrical installations of buildings. The installer shall comply with any additional local requirements mandated by the country and / or municipality.

Do not use this product if the flexible power cord or the electric vehicle cable is frayed, has broken insulation, or shows any other signs of damage.

Do not use this product if the enclosure or the vehicle plug is broken, cracked, open, or shows any other indication of damage.

The plug must be plugged into an appropriate electrical outlet that is properly installed in accordance with all local codes and ordinances. Do not modify the plug provided with the product. If the plug does not fit the electrical outlet, have a proper electrical outlet installed by a qualified electrician. If ground is missing, the charge cord indicators will indicate an electrical system fault and the vehicle may not charge.

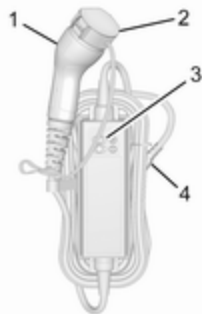

1. Vehicle plug
2. Protective cover
3. Status indicators
4. Wall plug





Charge cord status indicators

After plugging in the charge cord, it will perform a quick self test.

Verify the charge cord status.

- ☉ illuminates green and ☉ is off, the charge cord is ready to charge the vehicle.
- ☉ flashing green and ☉ is off: Electrical outlet / plug fault: The charge cord has detected that the

electrical outlet / plug overheated. Use another electrical outlet or have the electrical outlet serviced by a qualified electrician. Reset the charge cord by unplugging the charge cord from the electrical outlet and re-plugging it.

-  is off and  flashes red: Vehicle fault: The charge cord ground-fault circuit interrupter has tripped. Ensure that there is no physical damage to the charge cord and that the vehicle plug is seated completely and making a good connection. Reset the charge cord by unplugging from the electrical outlet and re-plugging it. If the fault remains, consult a workshop for a service.
-  solid green and  flashes red: charge cord fault: The charge cord has detected a potential problem with the charge cord. Reset the charge cord by unplugging from the electrical outlet and re-plugging it. If the fault remains, seek the assistance of a workshop.

If no status indicator is lit, ensure the electrical outlet is powered.

Charge level selection

Warning

If the capacity of the electrical circuit or AC socket is not known, only use the lowest charge level until the circuit capacity has been inspected by a qualified electrician. Using a charge level that exceeds either the electrical circuit or the AC outlet capacity may start a fire or damage the electrical circuit.

Note

By choosing a reduced charge level, the charging time is increased.

Charge limit selection can be made using the **Charge limit preference** screen on the Info Display.

Charge limit selection ⇨ 196.

Grounding instructions

This product must be grounded. If this product should malfunction or break down, grounding provides a path of least resistance for electric current to reduce the risk of electric shock. This product is equipped with a cord that has a grounding conductor. The plug must be plugged into an appropriate outlet that is properly installed and grounded in accordance with all local codes and ordinances.

Warning

Improper connection of the charge cord ground may cause electrical shock. Check with a qualified electrician if there is doubt as to whether the charge circuit is properly grounded. Do not modify the plug provided with the product. If it will not fit the electrical outlet, have a proper electrical outlet installed by a qualified electrician.

Charge cord mounting instructions

Choose an appropriate, solid location for mounting the charge cord. The appropriate height for mounting the charge cord is 91 cm from the floor.

Space the holes 18.7 cm apart.

Install the mounting screws leaving the head of the screws 5 mm from the surface.

Securely mount the charge cord on to the screws.

Connect the wall plug to the electrical outlet.

Connect the vehicle plug to the charge port.

Electrical requirements

Caution

Do not use portable or stationary backup generating equipment to charge the vehicle. This may cause damage to the vehicle's charging system. Only charge the vehicle from utility supplied power.

Charge limit selection ⇨ 196.

Reduced limit mode allows a non-dedicated circuit to be used but increases the charging time.

This vehicle is capable of being charged with standard vehicle charging equipment complying with one or more of the following standards:

- SAE J1772
- SAE J2847-2
- IEC 61851-1
- IEC 61851-22
- IEC 61851-23
- IEC 61851-24
- IEC 62196-1
- IEC 62196-2
- IEC 62196-3
- ISO 15118

Ensure that all local electrical code / standards are being met for a 10 A continuous load. Always follow the charging equipment installation instructions. Contact a workshop for more information.

⚠ Warning

If the capacity of the electrical circuit or AC socket is not known, only use the lowest charge level until the circuit capacity has been inspected by a qualified electrician. Using a charge level that exceeds either the electrical circuit or the AC outlet capacity may start a fire or damage the electrical circuit.

Vehicle care

General Information	209
Accessories and vehicle modifications	209
Lifting the vehicle	210
Vehicle storage	210
End-of-life vehicle recovery	211
Vehicle checks	211
Performing work	211
Bonnet	212
Cooling system	213
Washer fluid	215
Brakes	215
Brake fluid	215
Vehicle battery	216
Wiper blade replacement	218
Headlight aiming	218
Bulb replacement	219
Halogen bulbs	219
Xenon headlights	219
Front turn lights	219
Tail lights	220
Side turn lights	220
Number plate light	221

Electrical system	222
High voltage devices and wiring	222
Electrical system overload	222
Fuses	222
Engine compartment fuse box	224
Instrument panel fuse box	227
Vehicle tools	230
Tools	230
Wheels and tyres	230
Tyres	230
Winter tyres	231
Tyre designations	231
Tyre pressure	231
Tyre pressure monitoring system	232
Tread depth	234
Changing tyre and wheel size	235
Wheel covers	235
Tyre chains	236
Tyre repair kit	236
Jump starting	240
Towing	242
Towing the vehicle	242
Towing another vehicle	243
Appearance care	243
Exterior care	243
Interior care	245

General Information

Accessories and vehicle modifications

We recommend the use of genuine parts and accessories and factory approved parts specific for your vehicle type. We cannot assess or guarantee reliability of other products - even if they have a regulatory or otherwise granted approval.

Any modification, conversion or other changes made to standard vehicle specifications (including, without limitation, software modifications, modifications of the electronic control units) may invalidate the warranty offered by Opel. Furthermore, such changes may affect driver assistance systems and energy consumption. They may also invalidate the vehicle operating permit.

Caution

When transporting the vehicle on a train or on a recovery vehicle, the mud flaps might be damaged.

Lifting the vehicle

⚠ Warning

Lifting the vehicle improperly can cause serious injuries and damage to the vehicle.

The vehicle should be lifted only by well-trained staff at an authorised workshop.

Jacking position for lifting platform

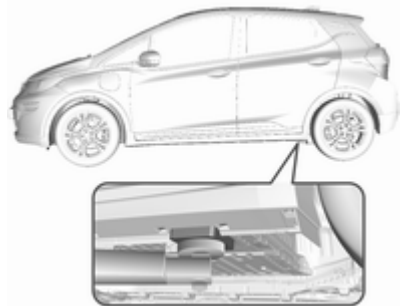

Rear arm position of the lifting platform at the underbody.



Front arm position of the lifting platform at the underbody.

Ramps may be needed under the front tyres to provide the necessary clearance for certain lifting platforms in this location.

Vehicle storage

Storage for a long period of time

If the vehicle is to be stored for several months:

- Wash and wax the vehicle.
- Have the wax in the engine compartment and underbody checked.

- Clean and preserve the rubber seals.
- Drain the washer fluid reservoir.
- Check the coolant antifreeze and corrosion protection.
- Adjust tyre pressure to the value specified for full load.
- Park the vehicle in a dry, well ventilated place. Engage **P**. Prevent the vehicle from rolling.
- Do not apply the parking brake.
- Open the bonnet, close all doors and lock the vehicle.

Up to four weeks

Plug in the charge cord.

Four weeks to twelve months

- Discharge the high voltage battery until two or three bars remain on the battery range indicator (battery symbol) on the instrument cluster.
- Do not plug in the charge cord.
- Always store the vehicle in a place with temperatures between $-10\text{ }^{\circ}\text{C}$ and $30\text{ }^{\circ}\text{C}$.

- Vehicle storage at extreme temperatures may cause damage to the high voltage battery.
- Remove the black negative (-) cable from the 12 V vehicle battery and attach a trickle charger to the vehicle battery terminals or keep the 12 V vehicle battery cables connected and trickle charge from the positive (+) and negative (-) terminals in the engine compartment.

Caution

The vehicle is equipped with an AGM 12 V vehicle battery, which can be damaged by using the incorrect type of trickle charger.

An AGM compatible charger must be used with the appropriate setting selected.

Follow the trickle charger manufacturer instructions.

After the 12 V vehicle battery cable is reconnected, it is possible that the vehicle may not operate. If this happens, the high voltage battery may need to be charged.

Putting back into operation

When the vehicle is to be put back into operation:

- Connect the clamp to the negative terminal of the 12 V vehicle battery. Activate the electronics of the power windows.
- Check tyre pressure.
- Fill up the washer fluid reservoir.
- Check the coolant level.
- Fit the number plate if necessary.

End-of-life vehicle recovery

Information on end-of-life vehicle recovery centres and the recycling of end-of-life vehicles is available on our website, where legally required. Only entrust this work to an authorised recycling centre.

Vehicle checks

Performing work

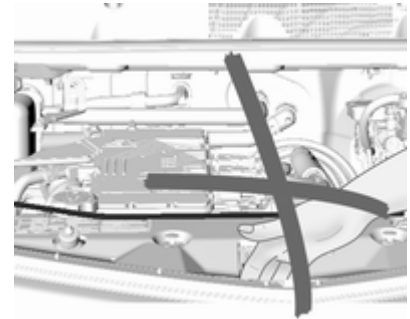

⚠ Danger

Never try to perform maintenance work on high voltage battery components yourself. You may be injured and the vehicle may be damaged. Service and repair of these high voltage battery components should only be performed by a trained service technician with proper knowledge and tools. Exposure to high

voltage may cause shock, burns, and even death. The high voltage components in the vehicle can only be serviced by technicians with special training.

High voltage components are identified by labels. Do not remove, open, take apart, or modify these components. High voltage cable or wiring has orange covering. Do not probe, tamper with, cut, or modify high voltage cable or wiring.

⚠ Warning

Only perform engine compartment checks when the vehicle is off.

The cooling fan may start operating even if the vehicle is off.

Caution

Even small amounts of contamination can cause damage to vehicle systems. Do not allow contaminants to contact the fluids, reservoir caps, or dipsticks.

Bonnet

Opening

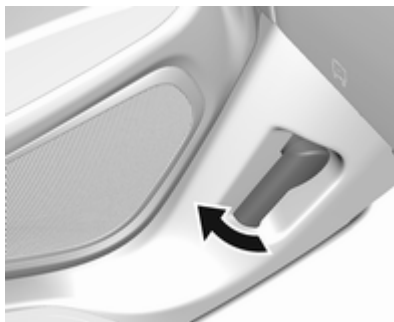

1. Pull the bonnet release lever and return it to its original position.



2. Move the safety catch sideways to the left vehicle side and open the bonnet.

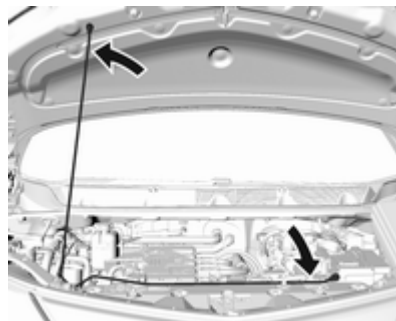

- Release the bonnet support from its retainer above the radiator support and place it securely into the slotted retainer in the bonnet.

Closing

Before closing the bonnet, press the support into the holder.

Lower the bonnet and let it fall into the latch from a low height (20-25 cm). Check that the bonnet is engaged.

Caution

Do not press the bonnet into the latch to avoid dents.

Cooling system

The vehicle has three different cooling systems.

Regularly check the coolant level of the respective cooling systems and have the cause of a possible coolant loss remedied by a workshop.

Caution

Make sure that you never run the vehicle with insufficient coolant.

A low coolant level can cause damage to the vehicle.

Heater cooling system

The coolant reservoir is located in the engine compartment.

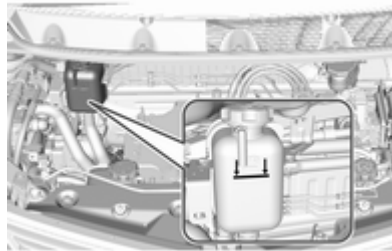

The coolant provides freeze protection down to approx. -28 °C.

Caution

Only use approved antifreeze.

If the engine cooling system is cold, the coolant level should be above the filling line mark. Top up if the level is low.

⚠ Warning

Allow the engine to cool before opening the cap. Carefully open the cap, relieving the pressure slowly.

To top up use a 1:1 mixture of approved coolant concentrate mixed with tap water. Install the cap tightly.

High voltage battery cooling system

⚠ Danger

The high voltage battery coolant may only be serviced by a qualified technician.

Improper handling could cause serious injuries or death.

The high voltage battery coolant reservoir is located on the front side of the engine compartment.

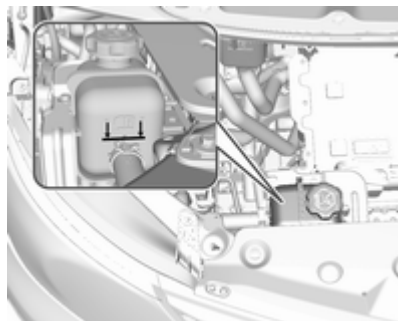

Check to see if coolant is visible in the high voltage battery coolant reservoir. If coolant is visible but the coolant level is below the cold fill line, there could be a leak within the cooling system.

If the coolant level is too low, seek the assistance of a workshop.

Power electronics and charger modules cooling system

⚠ Danger

The power electronics and charger modules coolant may only be serviced by a qualified technician.

Improper handling could cause serious injuries or death.

The power electronics and charger modules are cooled using the same coolant loop.

The power electronics and charger modules coolant reservoir is located on the front side of the engine compartment.

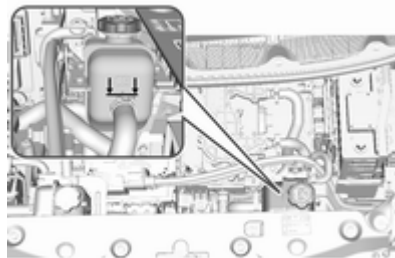

Check to see if coolant is visible in the power electronics and charger modules coolant reservoir. If coolant is visible but the coolant level is below the cold fill line, there could be a leak in the cooling system.

If the coolant level is too low, seek the assistance of a workshop.

Washer fluid

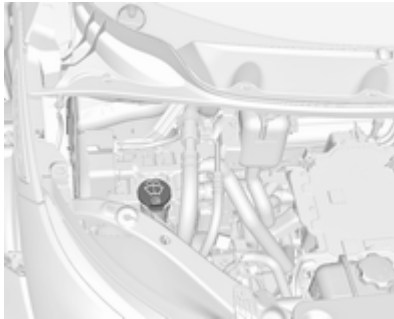

Fill with clean water mixed with a suitable quantity of approved windscreen washer fluid which contains antifreeze.

When adding windscreen washer fluid to the vehicle, be sure to read the manufacturer's instructions before use.

Caution

Only washer fluid with a sufficient antifreeze concentration provides protection at low temperatures or a sudden drop in temperature.

- When using concentrated washer fluid, follow the manufacturer's instructions for adding water.
- Do not mix water with ready-to-use washer fluid. Water can cause the solution to freeze and damage the washer fluid tank and other parts of the washer system.
- Fill the washer fluid tank only three quarters full when it is very cold. This allows for fluid expansion if freezing occurs, which could damage the tank if it is completely full.
- Do not use engine coolant (antifreeze) in the windscreen washer. It can damage the windscreen washer system and paint.

Washer fluid ⇨ 247.

Brakes

In the event of minimum thickness of the brake lining, a squealing noise sounds during braking.

Continued driving is possible but have the brake lining replaced as soon as possible.

Once new brake linings are installed, do not brake unnecessarily hard for the first few journeys.

Brake fluid

⚠ Warning

Brake fluid is poisonous and corrosive. Avoid contact with eyes, skin, fabrics and painted surfaces.

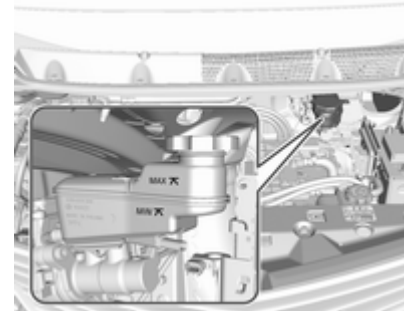

When the vehicle has not been running for at least 1 minute, the maximum fluid level is at the top of the reservoir body. When the vehicle is running, the brake fluid level must be between the **MIN** and **MAX** marks.

If the brake fluid level is below **MIN** seek the assistance of a workshop.

After work is done on the brake hydraulic system, make sure the fluid level is in the proper operating range between the **MIN** and **MAX** marks when the vehicle is running. Only use high-performance brake fluid approved for the vehicle. Consult a workshop.

Brake fluid ⇨ 247.

Vehicle battery

Danger

Only a trained service technician with the proper knowledge and tools may inspect, test or replace the high voltage battery.

Seek the assistance of a workshop if the high voltage battery needs service.

This vehicle has a high voltage battery and a 12 V vehicle battery.

If the vehicle is involved in a crash, the sensing system may shut down the high voltage system. If this occurs, the high voltage battery will be disconnected and the vehicle will not start.

A service message will be displayed in the Driver Information Centre.

Before the vehicle can be operated again, it must be serviced at a workshop.

Airbag system ⇨ 45.

A vehicle cover, which can reduce sun loading on the vehicle and improve high voltage battery life, is available from your Opel Ampera-e Service Partner.

The Opel Ampera-e Service Partner has information on how to recycle the high voltage battery.

Keep the vehicle plugged in, even when fully charged, to keep the high voltage battery temperature ready for the next drive. This is important when outside temperatures are extremely hot or cold.

Refer to the replacement number shown on the original 12 V vehicle battery label if a new 12 V vehicle battery is required. The vehicle has an Absorbed Glass Mat (AGM) 12 V vehicle battery.

Installation of a standard 12 V vehicle battery will result in reduced 12 V vehicle battery life. When using a 12 V battery charger on the AGM 12 V vehicle battery, note that some chargers have an AGM battery setting on the charger. If available, use the AGM setting on the charger to limit charge voltage to 14.8 V.

Follow the charger manufacturer's instructions.



Batteries do not belong in household waste. They must be disposed of at an appropriate recycling collection point.

There are connecting points for jump starting in the engine compartment.

Jump starting ⇨ 240.

Remove the 12 V vehicle battery black negative (-) cable from the 12 V vehicle battery to prevent the 12 V vehicle battery from running down, or use a battery trickle charger.

Ensure the vehicle is switched off before connecting or disconnecting the 12 V vehicle battery.

Vehicle storage ⇨ 210.

Battery discharge protection ⇨ 104.

Warning label



Meaning of symbols:

- No sparks, naked flames or smoking.
- Always shield eyes. Explosive gases can cause blindness or injury.
- Keep the 12 V vehicle battery out of reach of children.
- The 12 V vehicle battery contains sulphuric acid which could cause blindness or serious burn injuries.

- See the Owner's Manual for further information.
- Explosive gas may be present in the vicinity of the 12 V vehicle battery.

Post-crash label

The post-crash label is located in the door frame ⇨ 151.

Wiper blade replacement

Windscreen

1. Lift the wiper arm.

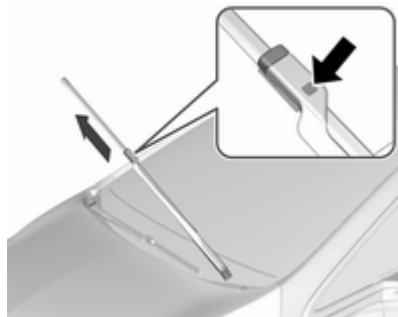

2. Press button to disengage the wiper blade and remove.
3. Lower wiper arm carefully.

Rear window

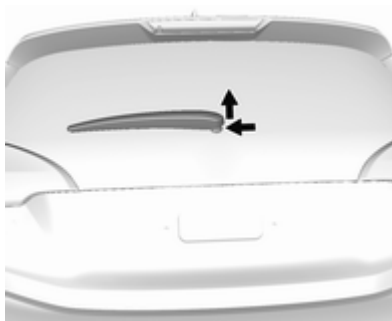

1. Pull the cover on the right until it disengages.
2. Slide the cover leftwards to unhook it from the blade assembly.
3. Remove the cover.
4. Lift the wiper arm.

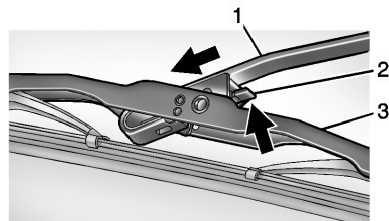

5. Push the release lever (2) to disengage the hook and pull the blade assembly (3) out of the wiper arm (1).
6. Push the new blade assembly securely on the wiper arm until the release lever clicks into place.
7. After wiper blade replacement, ensure that the cover hook slides into the slot in the blade assembly.
8. Snap the cover down to secure.

Headlight aiming

Headlight aim has been preset and should need no further adjustment. When driving in countries where the traffic drives on the opposite side of the road, it is not necessary to adjust the low beam.

If the vehicle is damaged in a crash, the headlight aim may be affected. If adjustment to the low beam is necessary, seek the assistance of a workshop.

Bulb replacement

Switch off the vehicle and the relevant light.

Only hold a new bulb at the base. Do not touch the bulb glass with bare hands.

Use only the same bulb type for replacement.

Replace headlight bulbs from within the engine compartment.

Bulb check

After a bulb replacement, switch on the vehicle, operate and check the lights.

Halogen bulbs

⚠ Warning

Halogen bulbs have pressurised gas inside and can burst if you drop or scratch the bulb. You or others could be injured. Be sure to read and follow the instructions on the bulb package.

Xenon headlights

⚠ Danger

Xenon headlights work under extremely high electrical voltage.

Do not touch. Have bulbs replaced by a workshop.

Bulbs for front turn lights and corner lighting can be changed.

Sidelight / Daytime running lights are designed as Light Emitting Diodes (LEDs) and cannot be replaced.

Front turn lights

Each turn light is accessible from behind via the respective wheel house:



1. Tilt the wheel and remove screws on the outside of the wheel house. Use the screwdriver provided with the vehicle tools.
2. Detach the respective wheel house panel partially.
3. Rotate the bulb holder anticlockwise to disengage and pull it out.
4. Pull the old bulb straight out of the holder and replace it with a new one.

5. Insert the lamp holder back into the turn light housing and rotate it clockwise.
6. Reinstall the wheel house panel with screws.

Tail lights

Tail light assembly in the rear bumper

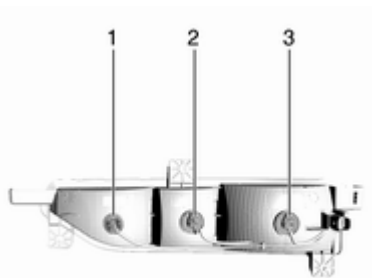

The tail light assembly is located in the rear bumper. The bulbs are accessible from the underside of the vehicle.

- (1) Rear fog light (driver side) / reversing light (passenger side)
 - (2) Turn light
 - (3) Tail / brake light
1. Turn the bulb holder anticlockwise and remove it from the reflector.
 2. Pull the bulb out of the bulb holder.
 3. Replace bulb.
 4. Insert the bulb holder into the reflector and rotate clockwise.

In case of failure, have LEDs replaced by a workshop.

Tail light assembly in the tailgate

The lights of the tail light assembly in the tailgate are LEDs and have to be replaced by a workshop.

Side turn lights

Have bulbs replaced by a workshop.

Number plate light



1. Insert a screwdriver into the slot to the left of the lamp and swivel the screwdriver.
2. Remove the lamp downwards, taking care not to pull at the cable.



3. Remove the lamp housing from the bulb holder by turning the bulb holder clockwise.



4. Pull the bulb out of the bulb holder and replace it.

5. Insert the bulb holder into the lamp housing and turn the bulb holder anticlockwise.
6. Insert the lamp into the tailgate and let it engage.

Some versions have LED number plate lights. In case of defective LEDs, have them replaced by a workshop.

Electrical system

High voltage devices and wiring

⚠ Warning

Exposure to high voltage may cause shock, burns, and even death. The high voltage components in the vehicle should only be serviced by specially trained technicians.

High voltage components are identified by labels. Do not remove, open, take apart, or modify these components. High voltage cable or wiring has orange covering. Do not probe, tamper with, cut, or modify high voltage cable or wiring.

Electrical system overload

The vehicle has fuses and circuit breakers to protect against an electrical system overload.

If the current electrical load is too heavy, the circuit breaker will open and close, protecting the circuit until the current load returns to normal or the problem is fixed. This greatly reduces the chance of circuit overload and fire caused by electrical problems.

Fuses and circuit breakers protect the following parts in the vehicle:

- Headlight wiring
- Windscreen wiper motor
- Power windows and other power accessories

Headlight wiring

An electrical overload may cause the lights to go on and off or in some cases to remain off. In this case, have the headlight wiring checked immediately by a workshop.

Windscreen wipers

If the wiper motor overheats due to blockage from heavy snow or ice, the windscreen wipers will stop until the motor has cooled down and the wiper control has been turned off. After

removal of the blockage, the wiper motor will restart when moving the wiper control to the desired operating position.

Although the circuit is protected from electrical overload, mechanical overload due to heavy snow or ice may cause wiper linkage damage.

Always clear ice and heavy snow from the windscreen before using the windscreen wipers. If the overload is caused by an electrical problem and not snow or ice, it must be serviced.

Fuses

Data on the replacement fuse must match the data on the defective fuse.

There are two fuse boxes in the vehicle:

- at the front left side of the engine compartment
- at the left side of the instrument panel

Before replacing a fuse, turn off the respective switch and the vehicle.

A blown fuse can be recognised by its melted wire. Do not replace the fuse until the cause of the fault has been remedied.

Caution

Do not replace the fuse until the cause of the fault has been remedied.

Some functions are protected by several fuses.

Fuses may also be inserted without existence of a function.

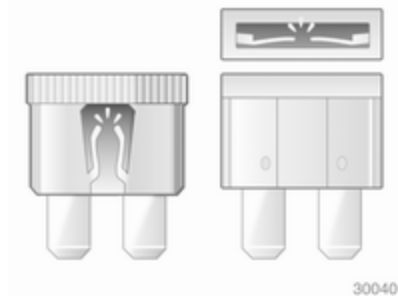

Fuse extractor

A fuse extractor is located in the fuse box in the engine compartment.

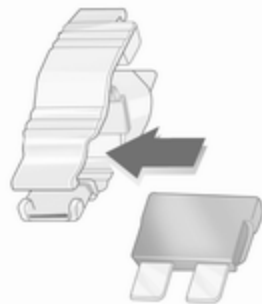
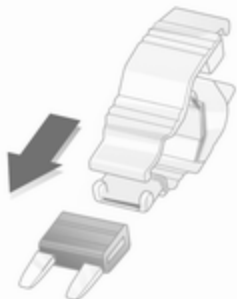

Place the fuse extractor on the various types of fuse from the top or side, and withdraw fuse.

Engine compartment fuse box

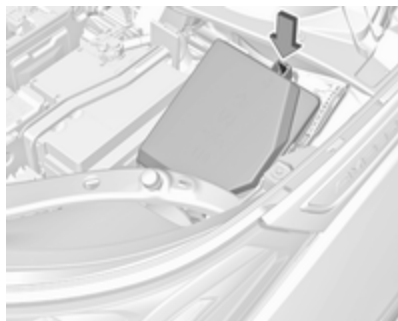

The fuse box is located at the left front side of the engine compartment.

To open the fuse block cover, press the clip and remove the cover.

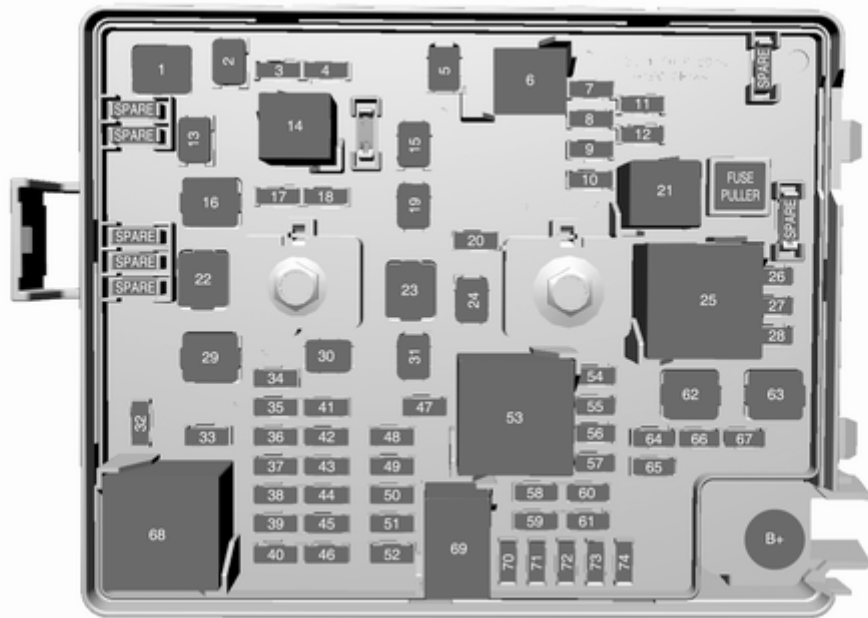

Number Usage

1	–
2	Power window rear
3	–
4	Rechargeable energy storage system 1
5	–
6	–
7	Left high beam headlight
8	Right high beam headlight
9	Left low beam headlight
10	Right low beam headlight
11	Horn
12	–
13	Front wiper motor driver
14	Tailgate
15	Front wiper motor co-driver
16	Electronic brake control module supply electronics

Number Usage

17	Rear wiper
18	Tailgate
19	Seat module front
20	Washer
21	–
22	Linear power module
23	Electronic brake control module supply motor
24	Seat module rear
25	–
26	Transmission range control module
27	Aero shutter
28	Auxiliary oil pump
29	E-booster motor source
30	Front power windows
31	In-panel bussed electrical centre

Number Usage

32	Rear window defogger
33	Heated exterior rear view mirror
34	Pedestrian friendly alert function
35	–
36	–
37	Current sensor
38	Rain sensor
39	–
40	E-booster (ECU)
41	Power line communication module
42	Automatic occupant sensing
43	Window switch
44	Rechargeable energy storage system

Number Usage

45	Vehicle integration control module
46	Integrated chassis control module
47	Headlight levelling device
48	Integrated chassis control module
49	Interior rear view mirror
50	–
51	E-booster
52	Rear camera
53	–
54	A/C control module
55	Rechargeable energy storage system pump
56	–
57	Power electronics coolant pump
58	Engine control module

Number Usage

59	Electric steering column lock
60	HVAC electric heater
61	On-board charging module
62	Transmission range control module 1
63	Electric cooling fan
64	Engine control module
65	Auxiliary heater pump
66	–
67	Drive unit controller
68	Rear window defogger
69	–
70	A/C control module
71	–
72	Transmission range control module

Number Usage

73	Single power inverter module
74	–

After having changed defective fuses, close the fuse box cover and press until it engages.

If the fuse box cover is not closed correctly, malfunctions may occur.

Instrument panel fuse box

The fuse box is located on the driver's side behind a cover in the instrument panel.



To open the compartment, compress the locking tabs, fold cover down and remove.

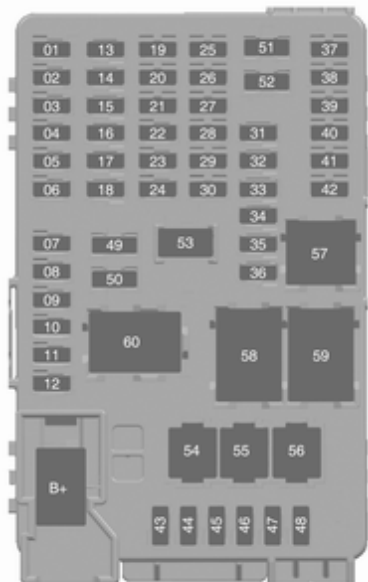

The instrument panel fuse block is on the left side of the instrument panel. To access the fuses, open the fuse panel door by pulling out.

Number Usage

1	Video processing module
2	Indicator light solar sensor
3	Side blind zone assistant
4	Passive entry, passive start
5	Central gateway module
6	Body control module 4
7	Body control module 3
8	Body control module 2
9	Body control module 1
10	Trailer interface module 1
11	Amplifier
12	Body control module 8
13	Data link connector 1
14	Automatic parking assist
15	–

Number Usage

16	Single power inverter module 1
17	Body control module 6
18	Body control module 5
19	–
20	–
21	–
22	–
23	USB
24	Wireless charging module
25	Reflected LED alert display
26	Automatic heated steering wheel
27	–
28	Instrument cluster 2
29	Trailer interface module 2
30	Headlight levelling device
31	OnStar

Number Usage

32	–
33	Heating, ventilation, and air conditioning module
34	–
35	Instrument panel cluster 1
36	Radio
37	–
38	–
39	–
40	–
41	–
42	–
43	Body control module 7
44	Sensing and diagnostic module
45	Front camera module
46	Vehicle integration control module

Number Usage

47	Single power inverter module 2
48	Electric steering column lock
49	Auxiliary jack
50	Steering wheel controls
51	Steering wheel controls backlighting
52	Smartphone remote function module
53	Auxiliary power outlet
54	–
55	Logistic
56	–
57	–
58	–
59	–
60	–

To reinstall the door, insert the bottom tab first, then push the door back into its original location.

Vehicle tools

Tools

Open the floor cover of the load compartment ↗ 60.

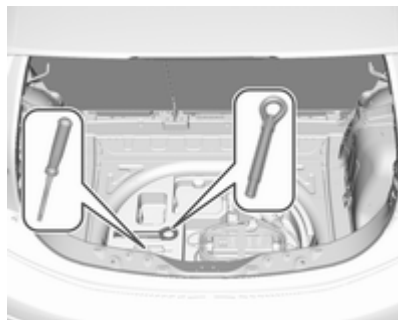

The towing eye and a screwdriver are located under a cover in the load compartment.

Tyre repair kit ↗ 236.

Wheels and tyres

Tyre condition, wheel condition

Drive over edges slowly and at right angles if possible. Driving over sharp edges can cause tyre and wheel damage. Do not trap tyres on the kerb when parking.

Regularly check the wheels for damage. Seek the assistance of a workshop in the event of damage or unusual wear.

Tyres

Self-sealing tyres

This vehicle may have self-sealing tyres. These tyres have a material inside that can seal punctures up to 6 mm in the tread area.

The tyre may lose air pressure if the sidewall is damaged or the tread puncture is too large. If the Tyre pressure monitoring system indicates the tyre pressure is low, inspect the tyre for damage and inflate it to the recommended pressure. If the tyre is

unable to maintain the recommended pressure, seek the assistance of a workshop.

Caution

Do not drive with a deflated self-sealing tyre as this could damage the tyre. Make sure the tyre is inflated to the recommended pressure or have it immediately repaired or replaced.

When tyre replacement is needed, replace with a self-sealing tyre, because the vehicle does not come with a spare tyre or tyre changing equipment.

Directional tyres

If possible, fit directional tyres such that they roll in the direction of travel. The rolling direction is indicated by a symbol (e.g. an arrow) on the sidewall.

The following applies to tyres fitted opposing the rolling direction:

- Driveability may be affected.
- Do not drive faster than 80 km/h.
- Drive particularly carefully on wet and snow-covered road surfaces.

Winter tyres

Winter tyres improve driving safety at temperatures below 7 °C and should therefore be fitted on all wheels.

All tyre sizes are permitted as winter tyres ⇨ 253.

In accordance with country-specific regulations, affix the speed sticker in the driver's field of view.

Tyre designations

E.g. **215/60 R 16 95 H**

215 : Tyre width, mm

60 : Cross-section ratio (tyre height to tyre width), %

R : Belt type: Radial

RF : Type: RunFlat

16 : Wheel diameter, inches

95 : Load index e.g. 95 is equivalent to 690 kg

H : Speed code letter

Speed code letter:

Q : up to 160 km/h

S : up to 180 km/h

T : up to 190 km/h

H : up to 210 km/h

V : up to 240 km/h

W : up to 270 km/h

Choose a tyre appropriate for the maximum speed of your vehicle.

The maximum speed is achievable at kerb weight with driver (75 kg) plus 125 kg payload. Optional equipment could reduce the maximum speed of the vehicle.

Performance ⇨ 251.

Tyre pressure

Check the pressure of cold tyres at least every 14 days and before any long journey.

This also applies to vehicles with tyre pressure monitoring system.



Tyre pressure ⇨ 253.

The tyre pressure information label on the left door frame indicates the original equipment tyres and the correspondent tyre pressures.

The tyre pressure data refers to cold tyres. It applies to summer and winter tyres.

The ECO tyre pressure serves to achieve the smallest amount of energy consumption possible.

Incorrect tyre pressures will impair safety, vehicle handling, comfort and efficiency and will increase tyre wear.

Tyre pressures differ depending on various options.

For the tyres approved for your vehicle, refer to the EEC Certificate of Conformity provided with your vehicle or other national registration documents.

The driver is responsible for correct adjustment of tyre pressure.

⚠ Warning

If the pressure is too low, this can result in considerable tyre warm-up and internal damage, leading to tread separation and even to tyre blow-out at high speeds.

⚠ Warning

For specific tyres the recommended tyre pressure as shown in the tyre pressure table may exceed the maximum tyre pressure as indicated on the tyre. Never exceed the maximum tyre pressure as indicated on the tyre.

If the tyre pressure must be reduced or increased on a vehicle with tyre pressure monitoring system, switch off the vehicle.

Temperature dependency

The tyre pressure depends on the temperature of the tyre. During driving, tyre temperature and pressure increase. Tyre pressure values provided on the tyre information label and tyre pressure chart are valid for cold tyres, which means at 20 °C.

The pressure increases by nearly 10 kPa for a 10 °C temperature increase. This must be considered when warm tyres are checked.

The tyre pressure value displayed in the Driver Information Centre shows the real tyre pressure. A cooled down tyre will show a decreased value, which does not indicate an air leak.

Tyre pressure monitoring system

The tyre pressure monitoring system checks the pressure of all four tyres once a minute when vehicle speed exceeds a certain limit.

Caution

Tyre pressure monitoring system warns only about low tyre pressure condition and does not replace regular tyre maintenance by the driver.

All wheels must be equipped with pressure sensors and the tyres must have the prescribed pressure.

Note

In countries where the tyre pressure monitoring system is legally required, the use of wheels without pressure sensors will invalidate the vehicle operating permit.

The current tyre pressures can be shown in the Driver Information Centre.

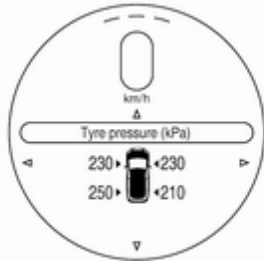

To access the tyre pressure page, choose vehicle info menu via right steering wheel buttons and press \triangle or ∇ to select tyre pressure.

To reset the system:

- Press and hold \checkmark until the tyre pressure monitoring system asks for a check.
- Press \checkmark again to confirm. The vehicle honks twice.

System status and pressure warnings are displayed by a message indicating the corresponding tyre in the Driver Information Centre.

The system considers the tyre temperature for the warnings.

Temperature dependency \diamond 231.



A detected low tyre pressure condition is indicated by the control indicator ! \diamond 80.

If ! illuminates, stop as soon as possible and inflate the tyres as recommended \diamond 253.

After inflating, some driving may be required to update the tyre pressure values in the Driver Information Centre. During this time ! may illuminate.

If ! illuminates at lower temperatures and extinguishes after driving, this could be an indicator for approaching a low tyre pressure condition. Check tyre pressure.

Vehicle messages \diamond 89.

If the tyre pressure must be reduced or increased, switch off vehicle.

Winter tyres or additional wheel sets must be fitted with sensors, otherwise the system will not work and control indicator ! illuminates continuously.

The tyre pressure monitoring system malfunction indicator is combined with the low tyre pressure control indicator. If the system detects a malfunction, ! will flash for approx. 1 minute and then remain continuously illuminated. This sequence will continue upon subsequent vehicle start-ups as long as the malfunction exists.

If the malfunction indicator ! is illuminated, the system may not be able to detect or signal low tyre pressure as intended. Tyre pressure monitoring system malfunctions may occur for a variety of reasons, including the installation of replacement or alternate tyres or wheels on the vehicle that prevent the tyre pressure monitoring system from functioning properly. Always check the tyre pressure monitoring system malfunction control indicator ! after replacing one or more tyres or wheels on your vehicle to ensure that the

replacement or alternative tyres and wheels allow the tyre pressure monitoring system to continue to function properly.

A spare wheel is not equipped with a pressure sensor. The tyre pressure monitoring system is not operational for these wheels. Control indicator (⚠) illuminates. For the further three wheels the system remains operational.

The use of commercially-available liquid tyre repair kits can impair the function of the system. Factory-approved repair kits can be used.

Operating electronic devices or being close to facilities using similar wave frequencies could disrupt the tyre pressure monitoring system.

Each time the tyres are replaced, tyre pressure monitoring system sensors must be dismantled and serviced. For the screwed sensor, replace valve core and sealing ring. For the clipped sensor, replace complete valve stem.

Vehicle loading status

Adjust tyre pressure to load condition according to the tyre information label or tyre pressure chart ⇨ 253, and select the appropriate setting in the menu **Tyre load** in the **Options** menu in the Driver Information Centre ⇨ 82. This setting is the reference for the tyre pressure warnings.

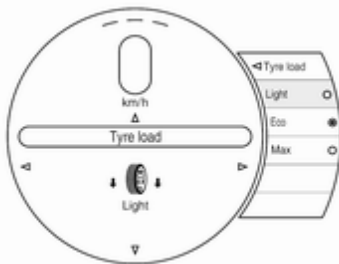

The available settings are:

- **Light** for comfort pressure up to three people.
- **Eco** for Eco pressure up to three people.
- **Max** for full loading.

Auto learn function

Each tyre pressure sensor has a unique identification code. The identification code must be matched to a new wheel position after rotating the wheels or exchanging the complete wheel set and if one or more tyre pressure sensors were replaced.

After changing wheels, the vehicle must be stationary for approx. 20 minutes before the system recalculates. The following relearn process takes up to 10 minutes of driving with a minimum speed of 20 km/h. In this event, (⚠) can be displayed or pressure values can swap in the Driver Information Centre.

If problems occur during the relearn process, a warning message will be displayed in the Driver Information Centre.

Tread depth

Check tread depth at regular intervals.

Tyres should be replaced for safety reasons at a tread depth of 2-3 mm (4 mm for winter tyres).

For safety reasons it is recommended that the tread depth of the tyres on one axle should not vary by more than 2 mm.



The legally permissible minimum tread depth (1.6 mm) has been reached when the tread has worn down as far as one of the tread wear indicators (TWI). Their position is indicated by markings on the sidewall.

If there is more wear at the front than the rear, swap round front wheels and rear wheels periodically. Ensure that the direction of rotation of the wheels remains the same.

Tyres age, even if they are not used. We recommend tyre replacement every six years.

Changing tyre and wheel size

If tyres of a different size than those fitted at the factory are used, it may be necessary to reprogramme the nominal tyre pressure and make other vehicle modifications.

After converting to a different tyre size, have the label with tyre pressures replaced and the tyre pressure monitoring system reinitialised ⇨ 232.

⚠ Warning

The use of unsuitable tyres or wheels may lead to accidents and will invalidate the vehicle operating permit.

Wheel covers

Wheel covers and tyres that are factory approved for the respective vehicle and comply with all of the relevant wheel and tyre combination requirements must be used.

If the wheel covers and tyres used are not factory approved, the tyres must not have a rim protection ridge.

Wheel covers must not impair brake cooling.

⚠ Warning

Use of unsuitable tyres or wheel covers could lead to sudden pressure loss and thereby accidents.

Tyre chains



Tyre chains are only permitted on the front wheels.

⚠ Warning

Damage may lead to tyre blowout.

Tyre chains used on a vehicle without the proper amount of clearance can cause damage to the brakes, suspension, or other vehicle parts. The area damaged by the tyre chains could cause loss of control and a crash. Use another type of traction device only if its manufacturer recommends it for the vehicle's tyre

size combination and road conditions. Follow that manufacturer's instructions. To avoid vehicle damage, drive slowly and readjust or remove the traction device if it contacts the vehicle. Do not spin the wheels. If traction devices are used, install them on the front tyres.

On tyres of size 205/55 R16 and 215/50 R17 only use special snow chains which are permitted for Opel Ampera-e and tyres of these sizes. For further information contact a workshop.

Tyre repair kit

Minor damage to the tyre tread can be repaired with the tyre repair kit.

Do not remove foreign bodies from the tyres.

Tyre damage exceeding 4 mm or that is at the tyre's sidewall cannot be repaired with the tyre repair kit.

⚠ Warning

Do not drive faster than 80 km/h.
Do not use for a lengthy period.
Steering and handling may be affected.

If you have a flat tyre:

Apply the parking brake and engage a forward gear or the reverse gear.

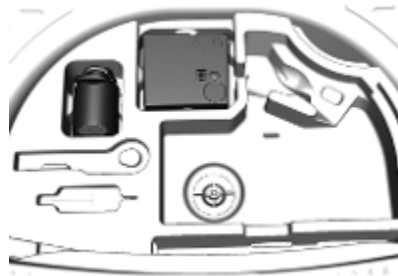

The tyre repair kit is in the tool box under the floor cover in the load compartment.

1. Open the floor cover.

- Remove the compressor and the sealant bottle.



- Remove the electrical connection cable and air hose from the storage compartments on the underside of the compressor.



- Screw the compressor air hose to the connection on the sealant bottle.
- Fit the sealant bottle into the retainer on the compressor.
Set the compressor near the tyre in such a way that the sealant bottle is upright.

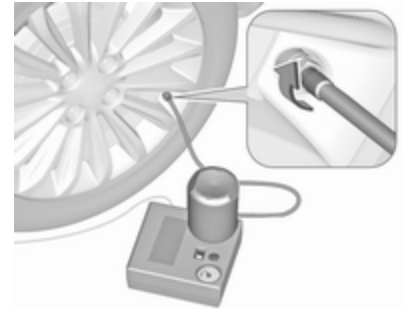

- Unscrew valve cap from defective tyre.
- Screw the filler hose to the tyre valve.
- The switch on the compressor must be set to O.
- Connect the compressor plug to the power outlet or cigarette lighter socket.
To avoid discharging the battery, we recommend running the engine.

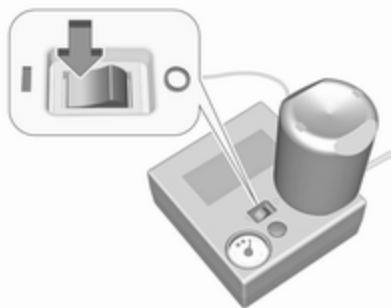

Set the rocker switch on the compressor to I. The tyre is filled with sealant.

10. The compressor pressure gauge briefly indicates up to 6 bar whilst the sealant bottle is emptying (approx. 30 seconds). Then the pressure starts to drop.
11. All of the sealant is pumped into the tyre. Then the tyre is inflated.
12. The prescribed tyre pressure should be obtained within 10 min. Tyre pressure ⇨ 253.

When the correct pressure is obtained, switch off the compressor.

If the prescribed tyre pressure is not obtained within 10 min, remove the tyre repair kit. Move the vehicle one tyre rotation. Reattach the tyre repair kit and continue the filling procedure for 10 min. If the prescribed tyre pressure is still not obtained, the tyre is too badly damaged. Seek the assistance of a workshop.



Drain excess tyre pressure with the button over the pressure indicator.

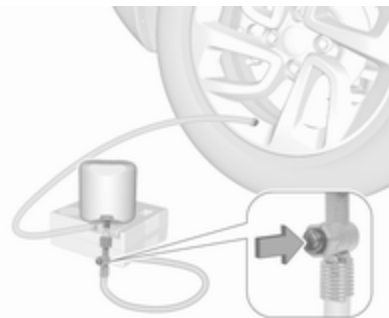

Depending on version the button can be located on the air hose.

Do not run the compressor for longer than 10 min.

13. Detach the tyre repair kit. Push catch on bracket to remove sealant bottle from bracket. Screw the tyre inflation hose to the free connection of the sealant bottle. This prevents sealant from escaping. Stow tyre repair kit in load compartment.
14. Remove any excess sealant using a cloth.

15. Take the label indicating maximum permitted speed from the sealant bottle and affix in the driver's field of view.
16. Continue driving immediately so that sealant is evenly distributed in the tyre. After driving approx. 10 km (but no more than 10 min), stop and check tyre pressure. Screw compressor air hose directly onto tyre valve and compressor when doing this.

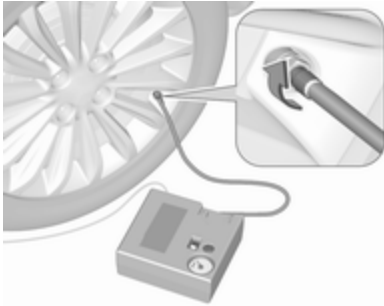

If tyre pressure is more than 1.3 bar, set it to the correct value. Repeat the procedure until there is no more loss of pressure.

- If the tyre pressure has fallen below 1.3 bar, the vehicle must not be used. Seek the assistance of a workshop.
17. Stow away tyre repair kit in load compartment.
Reinstall floor cover.
Rear floor storage cover ⇨ 60.

Note

The driving characteristics of the repaired tyre are severely affected, therefore have this tyre replaced.

If unusual noise is heard or the compressor becomes hot, turn compressor off for at least 30 min.

The built-in safety valve opens at a pressure of 7 bar.

Note the expiry date of the kit. After this date its sealing capability is no longer guaranteed. Pay attention to storage information on sealant bottle.

Replace the used sealant bottle. Dispose of the bottle as prescribed by applicable laws.

The compressor and sealant can be used from approx. -30 °C.

The adapters possibly supplied can be used to pump up other items e.g. footballs, air mattresses, inflatable dinghies etc. They can be located on the underside of the compressor. To remove, screw on compressor air hose and withdraw adapter.

Jump starting

Do not use quick charger.

If the 12 V vehicle battery is empty, the vehicle can be started using jump leads and the vehicle battery of another vehicle. Jump starting only works when the high voltage battery is charged.

⚠ Danger

The high voltage battery cannot be jump started either with another vehicle or battery charger. Personal injury, death, or damage to the vehicle could result.

⚠ Warning

Be extremely careful when using jump leads. Any deviation from the following instructions can lead to injuries or damage caused by vehicle battery explosion or damage to the electrical systems of both vehicles.

⚠ Warning

Avoid contact of the battery with eyes, skin, fabrics and painted surfaces. The fluid contains sulphuric acid which can cause injuries and damage in the event of direct contact.

⚠ Warning

Never jump start another vehicle by using the terminals located in the engine compartment. This could cause a fuse to overload in the vehicle.

- Never expose the 12 V vehicle battery to naked flames or sparks.
- A discharged 12 V vehicle battery can already freeze at a temperature of 0 °C. Defrost the frozen 12 V vehicle battery before connecting jump leads.
- Wear eye protection and protective clothing when handling a 12 V vehicle battery.

- Use a booster vehicle battery with the same voltage (12 V). Its capacity (Ah) must not be much less than that of the discharged 12 V vehicle battery.
- Use jump leads with insulated terminals and a cross section of at least 16 mm².
- Do not disconnect the discharged 12 V vehicle battery from the vehicle.
- Switch off all unnecessary electrical consumers.
- Do not lean over the 12 V vehicle battery during jump starting.
- Do not allow the terminals of one lead to touch those of the other lead.
- The vehicles must not come into contact with each other during the jump starting process.
- Apply the parking brake, shift selector lever into **P**.
- Open the positive terminal protection cap of both batteries.

Battery terminals in the engine compartment

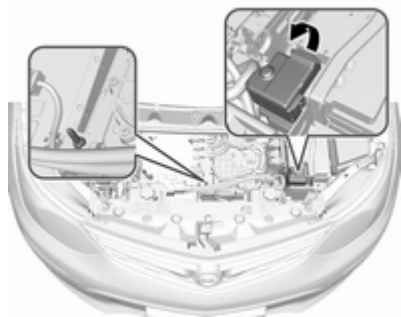

The battery terminals to jump start the vehicle are located in the engine compartment.

The positive battery terminal is located below a cover. Open the cover before jump starting the vehicle.

The negative battery terminal is stud on a bracket located near the charger modules.

Jump starting the vehicle

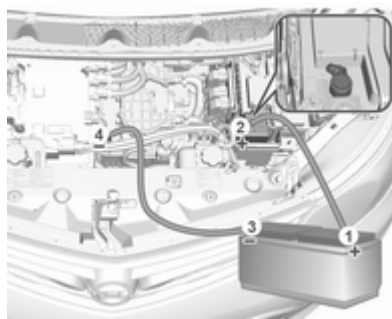

Lead connection order:

1. Connect the red lead to the positive terminal of the booster vehicle battery.
2. Connect the other end of the red lead to the positive terminal of your vehicle.
3. Connect the black lead to the negative terminal of the booster vehicle battery.
4. Connect the other end of the black lead to the negative battery terminal (stud).

Route the leads so that they cannot catch on rotating parts in the engine compartment.

To start the vehicle:

1. Start the engine of the vehicle providing the jump.
2. After 5 minutes, press **POWER**  to switch on the vehicle.

After the instrument cluster initialises, the vehicle will use power from the high voltage battery to charge the 12 V vehicle battery.

3. Switch on electrical consumers (e.g. headlights, heated rear window) of the vehicle receiving the jump start.
4. Reverse above sequence exactly when removing leads.

Towing

Towing the vehicle

Caution

Incorrect towing of a disabled vehicle may cause damage to the vehicle. The disabled vehicle should only be towed on a flatbed car carrier.

Ensure the vehicle is only towed by well trained technicians.



Wrap a cloth around the tip of a slot screwdriver to prevent paint damage. Insert the screwdriver in the slot at the

short edge of the cap. Release the cap by carefully moving the screwdriver sideways.

The towing eye is stowed with the vehicle tools ⇨ 230.



Screw in the towing eye anticlockwise as far as it will go until it stops in a horizontal position.

Attach a tow rope – or better still a tow rod – to the towing eye.

The towing eye must only be used for towing and not for recovering the vehicle.

Switch on the vehicle to release steering wheel lock and to permit operation of brake lights, horn and windscreen wiper.

Caution

Deactivate the driver assistance systems like active emergency braking ⇨ 168, otherwise the vehicle may automatically brake during towing.

Shift the selector lever of the electric drive unit into N.

Release the electric parking brake.

Caution

Drive slowly. Do not drive jerkily. Excessive tractive force can damage the vehicle.

When the vehicle is not running, considerably more force is needed to brake and steer.

To prevent the entry of exhaust gases from the towing vehicle, switch on the air recirculation and close the windows.

Seek the assistance of a workshop.

After towing, unscrew the towing eye.

Insert cap at the bottom and close.

Towing another vehicle

The vehicle is neither designed nor intended to tow a trailer or another vehicle.

Appearance care

Exterior care

Locks

The locks are lubricated at the factory using a high quality lock cylinder grease. Use de-icing agent only when absolutely necessary, as this has a degreasing effect and impairs lock function. After using a de-icing agent, have the locks regreased by a workshop.

Washing

The paintwork of your vehicle is exposed to environmental influences. Wash and wax your vehicle regularly. When using automatic vehicle washes, select a programme that includes waxing.

Do not apply waxes or polishes to uncoated plastic, vinyl, rubber, decals, simulated wood, or flat paint as damage can occur.

Bird droppings, dead insects, resin, pollen and the like should be cleaned off immediately, as they contain aggressive constituents which can cause paint damage.

If using a vehicle wash, comply with the vehicle wash manufacturer's instructions. The windscreen wiper and rear window wiper must be switched off. Remove external accessories such as roof racks etc.

If you wash your vehicle by hand, make sure that the insides of the wheel housings are also thoroughly rinsed out.

Clean edges and folds on opened doors and the bonnet as well as the areas they cover.

Clean bright metal mouldings with a cleaning solution approved for aluminium to avoid damages.

Caution

Always use a cleaning agent with a pH value of four to nine.

Do not use cleaning agents on hot surfaces.

Do not clean the engine compartment with a steam-jet or high-pressure jet cleaner.

Thoroughly rinse and leather-off the vehicle. Rinse leather frequently. Use separate leathers for painted and glass surfaces: remnants of wax on the windows will impair vision.

Have the door hinges of all doors greased by a workshop.

Do not use hard objects to remove spots of tar. Use tar removal spray on painted surfaces.

Exterior lights

Headlight and other light covers are made of plastic. Do not use any abrasive or caustic agents, do not use an ice scraper, and do not clean them dry.

Polishing and waxing

Wax the vehicle regularly (at the latest when water no longer beads). Otherwise, the paintwork will dry out.

Polishing is necessary only if the paint has become dull or if solid deposits have become attached to it.

Paintwork polish with silicone forms a protective film, making waxing unnecessary.

Plastic body parts must not be treated with wax or polishing agents.

Windows and wiper blades

Switch off wipers before handling in their areas.

Use a soft lint-free cloth or chamois leather together with window cleaner and insect remover.

When cleaning the rear window from inside, always wipe in parallel to the heating element to prevent damage.

For mechanical removal of ice, use a sharp-edged ice scraper. Press the scraper firmly against the glass so that no dirt can get under it and scratch the glass.

Remove dirt residues from smearing wiper blades by using a soft cloth and window cleaner. Also make sure to remove any residues such as wax, insect residues and similar from the window.

Ice residues, pollution and continuous wiping on dry windows will damage or even destroy the wiper blades.

Wheels and tyres

Do not use high-pressure jet cleaners.

Clean rims with a pH-neutral wheel cleaner.

Rims are painted and can be treated with the same agents as the body.

Paintwork damage

Rectify minor paintwork damage with a touch-up pen before rust forms. Have more extensive damage or rust areas repaired by a workshop.

Underbody

Some areas of the vehicle underbody have a PVC undercoating while other critical areas have a durable protective wax coating.

After the underbody is washed, check the underbody and have it waxed if necessary.

Bitumen / rubber materials could damage the PVC coating. Have underbody work carried out by a workshop.

Before and after winter, wash the underbody and have the protective wax coating checked.

Interior care

Interior and upholstery

Only clean the vehicle interior, including the instrument panel fascia and panelling, with a dry cloth or interior cleaner.

Clean the leather upholstery with clear water and a soft cloth. In case of heavy soiling, use leather care.

The instrument cluster and the displays should only be cleaned using a soft damp cloth. If necessary use a weak soap solution.

Do not spray cleaners directly on any switches or controls.

Clean fabric upholstery with a vacuum cleaner and brush. Remove stains with an upholstery cleaner.

Clothing fabrics may not be colourfast. This could cause visible discolourations, especially on light-coloured upholstery. Removable stains and discolourations should be cleaned as soon as possible.

Clean seat belts with lukewarm water or interior cleaner.

Caution

Close Velcro fasteners as open Velcro fasteners on clothing could damage seat upholstery.

The same applies to clothing with sharp-edged objects, like zips or belts or studded jeans.

Plastic and rubber parts

Plastic and rubber parts can be cleaned with the same cleaner as used to clean the body. Use interior cleaner if necessary. Do not use any other agent. Avoid solvents and petrol in particular. Do not use high-pressure jet cleaners.

Service and maintenance

General information	246
Service information	246
Recommended fluids, lubricants and parts	247
Recommended fluids and lubricants	247

General information

Service information

In order to ensure economical and safe vehicle operation and to maintain the value of your vehicle, it is of vital importance that all maintenance work is carried out at the proper intervals as specified.

The detailed, up-to-date service schedule for your vehicle is available at the workshop.

European service intervals

Maintenance of your vehicle is required every 30,000 km or after one year, whichever occurs first, unless otherwise indicated in the service display.

A shorter service interval can be valid for severe driving behaviour, e.g. for taxis and police vehicles.

The European service intervals are valid for the following countries:

Andorra, Austria, Belgium, Bosnia-Herzegovina, Bulgaria, Croatia, Cyprus, Czech Republic, Denmark, Estonia, Finland, France, Germany,

Greece, Greenland, Hungary, Iceland, Ireland, Italy, Latvia, Liechtenstein, Lithuania, Luxembourg, Macedonia, Malta, Monaco, Montenegro, Netherlands, Norway, Poland, Portugal, Romania, San Marino, Serbia, Slovakia, Slovenia, Spain, Sweden, Switzerland, United Kingdom.

International service intervals

Maintenance of your vehicle is required every 15,000 km or after one year, whichever occurs first, unless otherwise indicated in the service display.

Severe operating conditions exist if one or more of the following circumstances occur frequently: Cold starting, stop and go operation, mountain driving, driving on poor and sandy road surfaces, increased air pollution, presence of airborne sand and high dust content, driving at high altitude and large variations of temperature. Under these severe operating conditions, certain service work may be required more frequently than the regular service interval.

The international service intervals are valid for the countries which are not listed in the European service intervals.

Confirmations

Confirmation of service is recorded in the Service and warranty booklet. The date and mileage is completed with the stamp and signature of the servicing workshop.

Make sure that the Service and warranty booklet is completed correctly as continuous proof of service is essential if any warranty or goodwill claims are to be met, and is also a benefit when selling the vehicle.

Recommended fluids, lubricants and parts

Recommended fluids and lubricants

Only use products that have been tested and approved. Damage resulting from the use of non-approved materials will not be covered by the warranty.

Warning

Operating materials are hazardous and could be poisonous. Handle with care. Pay attention to information given on the containers.

Coolant and antifreeze

Use only organic acid type-long life coolant (LLC) antifreeze approved for the vehicle. Consult a workshop. The system is factory filled with coolant designed for excellent corrosion protection and frost protection down to approx. -28°C . In northern countries with very low temperatures the factory filled coolant provides frost protection down to approx. -37°C . This concentration should be maintained all year round. The use of additional coolant additives that intend to give additional corrosion protection or seal against minor leaks can cause function problems. Liability for consequences resulting from the use of additional coolant additives will be rejected.

Washer fluid

Use only washer fluid approved for the vehicle to prevent damage of wiper blades, paintwork, plastic and rubber parts. Consult a workshop.

Brake fluid

Over time, brake fluid absorbs moisture which will reduce braking effectiveness. The brake fluid should therefore be replaced at the specified interval.

Technical data

Vehicle identification	249
Vehicle Identification Number ..	249
Identification plate	249
Vehicle data	251
Engine data	251
Performance	251
Vehicle weight	251
Vehicle dimensions	252
Tyre pressures	253

Vehicle identification

Vehicle Identification Number



The Vehicle Identification Number may be embossed on the instrument panel, visible through the windscreen, or in the engine compartment on the right body panel.

The Vehicle Identification Number may be stamped on the identification plate, or in the engine compartment on the body panel.

Identification plate



The identification plate is located on the front left or right door frame.

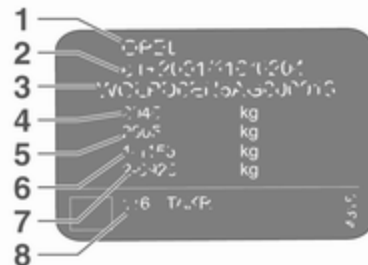

Information on identification label:

- 1 : manufacturer
- 2 : type approval number
- 3 : vehicle identification number
- 4 : permissible gross vehicle weight rating in kg
- 5 : permissible gross train weight in kg
- 6 : maximum permissible front axle load in kg
- 7 : maximum permissible rear axle load in kg
- 8 : vehicle-specific or country-specific data

The combined total of front and rear axle loads must not exceed the permissible gross vehicle weight. For example, if the front axle is bearing its maximum permissible load, the rear axle can only bear a load that is equal to the gross vehicle weight minus the front axle load.

The technical data is determined in accordance with European Community standards. We reserve the right to make modifications. Specifications in the vehicle documents always have priority over those given in this manual.

Vehicle data

Engine data

Power [kW]	150
Torque [Nm]	360

Performance

Maximum speed [km/h]	150
----------------------	-----

Vehicle weight

Kerb weight [kg]	1691
------------------	------

Optional equipment and accessories increase the kerb weight.

Loading information ↪ 62.

Vehicle dimensions

Length [mm]	4164
Width without exterior mirrors [mm]	1765
Width with two exterior mirrors [mm]	2039
Height (without antenna) [mm]	1594
Length of load compartment floor [mm]	681
Length of load compartment with folded rear seats [mm]	1459
Load compartment width [mm]	1154
Load compartment height [mm]	921
Wheelbase [mm]	2600
Turning circle diameter [m]	10.8

Tyre pressures

Tyres	Comfort with up to three people		ECO with up to three people		With full load	
	front	rear	front	rear	front	rear
	[kPa/bar] ([psi])	[kPa/bar] ([psi])	[kPa/bar] ([psi])	[kPa/bar] ([psi])	[kPa/bar] ([psi])	[kPa/bar] ([psi])
215/50 R17	220/2.2 (32)	260/2.6 (37)	270/2.7 (39)	300/3.0 (44)	240/2.4 (35)	280/2.8 (40)
205/55 R16						

Customer information

Customer information	254
Declaration of conformity	254
REACH	255
Software acknowledgement	256
Software update	257
Registered trademarks	258
Vehicle data recording and privacy	258
Event data recorders	258
Radio Frequency Identification (RFID)	261

Customer information

Declaration of conformity

Transmission systems

This vehicle has systems that transmit and / or receive radio waves subject to Directive 2014/53/EU. The manufacturers of the systems listed below declare conformity with Directive 2014/53/EU. The full text of the EU declaration of conformity for each system is available at the following internet address: www.opel.com/conformity.

Importer is
Opel / Vauxhall, Bahnhofplatz,
65423 Ruesselsheim am Main,
Germany.

Antenna module

Laird

Daimlerring 31, 31135 Hildesheim,
Germany

Operation frequency: N/A

Maximum output: N/A

Kathrein Automotive GmbH

Roemerring 1, 31137 Hildesheim,
Germany

Operation frequency: N/A

Maximum output: N/A

Electronic key transmitter

Denso Corporation

1-1, Showa-cho, Kariya-shi, Aichi-
ken 448-8661, Japan

Operation frequency: 433.92 MHz

Maximum output: -5.88 dBm

Electronic key receiver

Denso Corporation

Waldeckerstrasse 11, 64546
Moerfelden-Walldorf, Germany

Operation frequency: 125 kHz

Maximum output: -0.14 dBm

Immobiliser

Robert Bosch GmbH

Robert Bosch Platz 1, 70839
Gerlingen, Germany

Operation frequency: 125 kHz

Maximum output:

5.1 dB μ A/m @ 10 m

Infotainment system IntelliLink-e

LG Electronics

European Shared Service Center
B.V., Krijgsman 1, 1186 DM
Amstelveen, The Netherlands

Operation frequency (MHz)	Maximum output (dBm)
---------------------------	----------------------

2400.0 - 2483.5	4.0
-----------------	-----

2400.0 - 2483.5	13.0
-----------------	------

5725.0 - 5850.0	13.0
-----------------	------

OnStar module

LG Electronics

European Shared Service Center
B.V., Krijgsman 1, 1186 DM
Amstelveen, The Netherlands

Operation frequency (MHz)	Maximum output (dBm)
---------------------------	----------------------

2402 - 2480	4
-------------	---

2412 - 2462	18
-------------	----

880 - 915	33
-----------	----

1710 - 1785	24
-------------	----

1850 - 1910	24
-------------	----

1920 - 1980	24
-------------	----

2500 - 2570	23
-------------	----

Radar unit

Hella KGaA Hueck & Co.

Rixbecker Strasse 75, 59552
Lippstadt, Germany

Operation frequency:

24.05 - 24.25 GHz

Maximum output: 20 EIRP dBm

Radio remote control receiver

Robert Bosch GmbH

Robert Bosch Platz 1, 70839
Gerlingen, Germany

Operation frequency: N/A

Maximum output: N/A

Radio remote control transmitter

Robert Bosch GmbH

Robert Bosch Platz 1, 70839
Gerlingen, Germany

Operation frequency: 433.92 MHz

Maximum output: -4 dBm

Smartphone remote module

Denso Corporation

Waldeckerstrasse 11, 64546
Moerfelden-Walldorf, Germany

Operation frequency:

2400 - 2482 MHz

Maximum output: 3 dBm

Tyre pressure sensors

Schrader Electronics Ltd.

11 Technology Park, Belfast Road,
Antrim BT41 1QS, Northern Ireland,
United Kingdom

Operation frequency: 433.92 MHz

Maximum output: 10 dBm

REACH

Registration, Evaluation, Authorisation and Restriction of Chemicals (REACH) is a European Union regulation adopted to improve the protection of human health and the environment from the risks that can be posed by chemicals. Visit www.opel.com/reach for further information and for access to the Article 33 communication.

Software acknowledgement

Certain OnStar components include libcurl and unzip software and other third party software. Below are the notices and licenses associated with libcurl and unzip and for other third party software please see <http://www.lg.com/global/support/opensource/index>.

libcurl

Copyright and permission notice

Copyright (c) 1996 - 2010, Daniel Stenberg, <daniel@haxx.se>.

All rights reserved.

Permission to use, copy, modify, and distribute this software for any purpose with or without fee is hereby granted, provided that the above copyright notice and this permission notice appear in all copies.

The software is provided "as is", without warranty of any kind, express or implied, including but not limited to the warranties of merchantability, fitness for a particular purpose and non-infringement of third party rights. In no event shall the authors or

copyright holders be liable for any claim, damages or other liability, whether in an action of contract, tort or otherwise, arising from, out of or in connection with the software or the use or other dealings in the software.

Except as contained in this notice, the name of a copyright holder shall not be used in advertising or otherwise to promote the sale, use or other dealings in this Software without prior written authorization of the copyright holder.

unzip

This is version 2005-Feb-10 of the Info-ZIP copyright and license. The definitive version of this document should be available at <ftp://ftp.info-zip.org/pub/infzip/license.html> indefinitely.

Copyright (c) 1990-2005 Info-ZIP. All rights reserved.

For the purposes of this copyright and license, "Info-ZIP" is defined as the following set of individuals:

Mark Adler, John Bush, Karl Davis, Harald Denker, Jean-Michel Dubois, Jean-loup Gailly, Hunter Goatley, Ed

Gordon, Ian Gorman, Chris Herborth, Dirk Haase, Greg Hartwig, Robert Heath, Jonathan Hudson, Paul Kienitz, David Kirschbaum, Johnny Lee, Onno van der Linden, Igor Mandrichenko, Steve P. Miller, Sergio Monesi, Keith Owens, George Petrov, Greg Roelofs, Kai Uwe Rommel, Steve Salisbury, Dave Smith, Steven M. Schweda, Christian Spieler, Cosmin Truta, Antoine Verheijen, Paul von Behren, Rich Wales, Mike White.

This software is provided "as is," without warranty of any kind, express or implied. In no event shall Info-ZIP or its contributors be held liable for any direct, indirect, incidental, special or consequential damages arising out of the use of or inability to use this software.

Permission is granted to anyone to use this software for any purpose, including commercial applications, and to alter it and redistribute it freely, subject to the following restrictions:

1. Redistributions of source code must retain the above copyright notice, definition, disclaimer, and this list of conditions.
2. Redistributions in binary form (compiled executables) must reproduce the above copyright notice, definition, disclaimer, and this list of conditions in documentation and / or other materials provided with the distribution. The sole exception to this condition is redistribution of a standard UnZipSFX binary (including SFXWiz) as part of a self-extracting archive; that is permitted without inclusion of this license, as long as the normal SFX banner has not been removed from the binary or disabled.
3. Altered versions—including, but not limited to, ports to new operating systems, existing ports with new graphical interfaces, and dynamic, shared, or static library versions—must be plainly marked as such and must not be misrepresented as being the original source. Such altered

versions also must not be misrepresented as being Info-ZIP releases—including, but not limited to, labelling of the altered versions with the names “Info-ZIP” (or any variation thereof, including, but not limited to, different capitalizations), “Pocket UnZip,” “WiZ” or “MacZip” without the explicit permission of Info-ZIP. Such altered versions are further prohibited from misrepresentative use of the Zip-Bugs or Info-ZIP e-mail addresses or of the Info-ZIP URL(s).

4. Info-ZIP retains the right to use the names “Info-ZIP,” “Zip,” “UnZip,” “UnZipSFX,” “WiZ,” “Pocket UnZip,” “Pocket Zip,” and “MacZip” for its own source and binary releases.

Software update

The Infotainment system can download and install selected software updates over a wireless connection.

Note

The availability of these over-the-air vehicle software updates varies by vehicle and country. Find more information on our home page.

Internet connection

Downloading over-the-air vehicle software updates requires internet connectivity, which can be accessed through the vehicle’s built-in OnStar connection or another password-protected Wi-Fi hotspot, e.g. provided by a mobile phone.

To connect the Infotainment system to a hotspot, select **Settings** on the home screen, **Wi-Fi** and then **Manage Wi-Fi Networks**. Select the desired Wi-Fi network, and follow the on-screen prompts.

Updates

The system will prompt for certain updates to be downloaded and installed. There is also an option to check for updates manually.

To manually check for updates, select **Settings** on the home screen, **Software information** and then **Software Update**. Follow the on-screen prompts.

Note

Steps for downloading and installing updates may vary by vehicle.

Note

During the installation process, the vehicle may not be operational.

Registered trademarks

Apple Inc.

Apple CarPlay™ is a trademark of Apple Inc.

App Store® and iTunes Store® are registered trademarks of Apple Inc.

iPhone®, iPod®, iPod touch®, iPod nano®, iPad® and Siri® are registered trademarks of Apple Inc.

Bluetooth SIG, Inc.

Bluetooth® is a registered trademark of Bluetooth SIG, Inc.

DivX, LLC

DivX® and DivX Certified® are registered trademarks of DivX, LLC.

EnGIS Technologies, Inc.

BringGo® is a registered trademark of EnGIS Technologies, Inc.

Google Inc.

Android™ and Google Play™ Store are trademarks of Google Inc.

Stitcher Inc.

Stitcher™ is a trademark of Stitcher, Inc.

Verband der Automobilindustrie e.V.

AdBlue® is a registered trademark of the VDA.

Vehicle data recording and privacy

Event data recorders

Electronic control units are installed in your vehicle. Control units process data which is received by vehicle sensors, for example, or which they generate themselves or exchange amongst themselves. Some control units are necessary for the safe functioning of your vehicle, others assist you while you drive (driver assistance systems), while others provide comfort or infotainment functions.

The following contains general information about data processing in the vehicle. You will find additional information as to which specific data is uploaded, stored and passed on to third parties and for what purpose in your vehicle under the key word Data Protection closely linked to the references for the affected functional characteristics in the relevant owner's manual or in the general terms of sale. These are also available online.

Operating data in the vehicle

Control units process data for operation of the vehicle.

This data includes, e.g.:

- vehicle status information (e.g. speed, movement delay, lateral acceleration, wheel rotation rate, "seat belts fastened" display)
- ambient conditions (e.g. temperature, rain sensor, distance sensor)

As a rule such data is transient, not stored for longer than an operational cycle, and only processed on board the vehicle itself. Control units often include data storage (including the vehicle key). This is used to allow information to be documented temporarily or permanently on vehicle condition, component stress, maintenance requirements and technical events and errors.

Depending on technical equipment level, the data stored is as follows:

- system component operating states (e.g. fill level, tyre pressure, battery status)
- faults and defects in important system components (e.g. lights, brakes)
- system reactions in special driving situations (e.g. triggering of an airbag, actuation of the stability control systems)
- information on events damaging the vehicle
- for electric vehicles the amount of charge in the high-voltage battery, estimated range

In special cases (e.g. if the vehicle has detected a malfunction), it may be necessary to save data that would otherwise just be volatile.

When you use services (e.g. repairs, maintenance), the operating data saved can be read together with the vehicle identification number and used when necessary. Staff working for the service network (e.g. garages, manufacturers) or third parties (e.g.

breakdown services) can read the data from the vehicle. The same applies to warranty work and quality assurance measures.

Data is generally read via the OBD (On-Board Diagnostics) port prescribed by law in the vehicle. The operating data which is read out, documents the technical condition of the vehicle or individual components and assists with fault diagnosis, compliance with warranty obligations and quality improvement. This data, in particular information on component stress, technical events, operator errors and other faults, is transmitted to the manufacturer where appropriate, together with the vehicle identification number. The manufacturer is also subject to product liability. The manufacturer potentially also uses operating data from vehicles for product recalls. This data can also be used to check customer warranty and guarantee claims.

Fault memories in the vehicle can be reset by a service company when carrying out servicing or repairs or at your request.

Comfort and infotainment functions

Comfort settings and custom settings can be stored in the vehicle and changed or reset at any time.

Depending on the equipment level in question, these include

- seat and steering wheel position settings
- chassis and air conditioning settings
- custom settings such as interior lighting

You can input your own data in the infotainment functions for your vehicle as part of the selected features.

Depending on the equipment level in question, these include

- multimedia data such as music, videos or photos for playback in an integrated multimedia system
- address book data for use with an integrated hands-free system or an integrated navigation system

- input destinations
- data on the use of online services

This data for comfort and infotainment functions can be stored locally in the vehicle or be kept on a device that you have connected to the vehicle (e.g. a smartphone, USB stick or MP3 player). Data that you have input yourself can be deleted at any time.

This data can only be transmitted out of the vehicle at your request, particularly when using online services in accordance with the settings selected by you.

Smartphone integration, e.g. Android Auto or Apple CarPlay

If your vehicle is equipped accordingly, you can connect your smartphone or another mobile device to the vehicle so that you can control it via the controls integrated in the vehicle. The smartphone image and sound can be output via the multimedia system in this case. At the same time, specific information is transmitted to your smartphone. Depending on the type of integration,

this includes data such as position data, day / night mode and other general vehicle information. For more information, please see the operating instructions for the vehicle / infotainment system.

Integration allows selected smartphone apps to be used, such as navigation or music playback. No further integration is possible between smartphone and vehicle, in particular active access to vehicle data. The nature of further data processing is determined by the provider of the app used. Whether you can define settings, and if so which ones, is dependent on the app in question and your smartphone's operating system.

Online services

If your vehicle has a radio network connection, this allows data to be exchanged between your vehicle and other systems. The radio network connection is made possible by means of a transmitter device in your vehicle or a mobile device provided by you (e.g. a smartphone). Online functions can be used via this radio network connection. These include online services and applications / apps provided to you by the manufacturer or other providers.

Proprietary services

In the case of the manufacturer's online services, the relevant functions are described by the manufacturer in an appropriate location (e.g. Owner's Manual, the manufacturer's website) and the associated data protection information is provided. Personal data may be used to provide online services. Data exchange for this purpose takes place via a protected connection, e.g. using the manufacturer's IT systems provided for the purpose. Collection,

processing and use of personal data for the purposes of preparation of services take place solely on the basis of legal permission, e.g. in the case of a legally prescribed emergency communication system or a contractual agreement, or by virtue of consent.

You can activate or deactivate the services and functions (which are subject to charges to some extent) and, in some cases, the vehicle's entire radio network connection. This does not include statutory functions and services such as an emergency communication system.

Third party services

If you make use of online services from other providers (third parties), these services are subject to the liability and data protection and usage conditions of the provider in question. The manufacturer frequently has no influence over the content exchanged in this regard.

Therefore, please note the nature, scope and purpose of the collection and use of personal data within the scope of third party services provided by the service provider in question.

Radio Frequency Identification (RFID)

RFID technology is used in some vehicles for functions such as tyre pressure monitoring and immobiliser. It is also used in connection with conveniences such as radio remote controls for door locking / unlocking and starting. RFID technology in Opel vehicles does not use or record personal information or link with any other Opel system containing personal information.

Index

- A**
- Accessories and vehicle modifications 209
 - Activating Bluetooth music..... 127
 - Activating phone..... 136
 - Activating radio..... 119
 - Activating USB audio..... 127
 - Activating USB movie..... 130
 - Activating USB picture..... 129
 - Active emergency braking..... 168
 - Adjustable air vents 145
 - Airbag and belt tensioners 78
 - Airbag deactivation 49, 78
 - Airbag label..... 45
 - Airbag system 45
 - Air conditioning regular operation 146
 - Air intake 146
 - Air vents..... 145
 - Antilock brake system 157
 - Antilock brake system (ABS) 79
 - Anti-theft alarm system 30
 - Anti-theft locking system 29
 - Appearance care..... 243
 - Armrest..... 40, 42
 - Armrest storage 58
 - Audio files..... 125
 - Automatic anti-dazzle 33
 - Automatic light control 99
 - Automatic locking 25
- Auto volume..... 115
- AUX**
- Connecting device..... 125
 - General information..... 125
- B**
- Basic operation..... 112
 - Battery discharge protection 104
 - Battery gauge..... 74
 - Battery voltage 90
 - Belts..... 42
 - Bluetooth
 - Bluetooth connection..... 133
 - Bluetooth music menu..... 127
 - Connecting device..... 125
 - General information..... 125
 - Pairing..... 133
 - Phone..... 136
 - Bluetooth connection..... 133
 - Bonnet 212
 - Brake fluid 215, 247
 - Brakes 157, 215
 - Brake system 79
 - Breakdown..... 242
 - BringGo..... 131
 - Bulb replacement 219
- C**
- Call
- Functions during a call..... 136
 - Incoming call..... 136

Initiating a phone call.....	136
Ring tone.....	136
Call history.....	136
Car wash mode.....	153
Central locking system	20
Centre console storage	58
Changing tyre and wheel size ...	235
Charge cord.....	205
Charge limit selection.....	196
Charge mode selection.....	196
Charge rate selection.....	196
Charging.....	192
Charging override.....	196
Charging status.....	203
Charging system	78
Child locks	26
Child restraint installation locations	53
Child restraints.....	51
Child restraint systems	51
Climate control	13
Clock.....	69
Control elements Infotainment system.....	107
Steering wheel.....	107
Control elements overview.....	107
Control indicators.....	77
Control of the vehicle	148
Controls.....	65
Convex shape	32

Coolant.....	213
Coolant and antifreeze.....	247
Cooling system.....	213
Cruise control	81, 163
Cupholders	57
Curtain airbag system	49

D

DAB.....	123
Danger, Warnings and Cautions ...	2
Daytime running lights	101
Declaration of conformity.....	254
Delayed locking.....	25
Digital audio broadcasting.....	123
Directional tyres.....	230
Displaying pictures.....	129
Display settings.....	129, 130
Door open	82
Doors.....	29
Drive modes.....	153
Driver assistance systems.....	163
Driver Information Centre.....	82
Driving economically.....	147
Driving efficiency gauge.....	74
Driving hints.....	147, 148

E

Electric adjustment	32
Electrical requirements.....	208
Electrical system.....	222
Electrical system overload	222

Electric drive unit.....	14, 153
Electric parking brake.....	79, 158
Electric parking brake fault.....	79
Electric rate schedule.....	196
Electric vehicle operation modes	153
Electronic climate control system	141
Electronic key system.....	19
Electronic Stability Control.....	162
Electronic Stability Control and Traction Control system.....	80
Electronic Stability Control off.....	80
Emergencies.....	148
Emergency call.....	135
End-of-life vehicle recovery	211
Engine compartment fuse box ...	224
Engine data	251
Entry lighting	104
Event data recorders.....	258
Exit lighting	104
Exterior care	243
Exterior light	81
Exterior lighting	10, 98
Exterior mirrors.....	32

F

File formats	
Audio files.....	125
Movie files.....	125
Picture files.....	125
First aid kit	61

Fixed air vents	145
Folding mirrors	32
Following distance indication.....	168
Forward collision alert.....	166
Front airbag system	48
Front pedestrian protection.....	171
Front seats.....	38
Front turn lights	219
Fuses	222

G

Gauges.....	74
General information....	125, 132, 133
AUX.....	125
Bluetooth.....	125
DAB.....	123
Infotainment system.....	105
Phone.....	133
Smartphone applications.....	125
USB.....	125
Glovebox	57

H

Halogen bulbs.....	219
Hand brake.....	157, 158
Hazard warning flashers	101
Headlight aiming.....	218
Headlight flash	101
Headlight range adjustment	101
Headlights.....	98
Headlights when driving abroad	101

Head restraint adjustment	6
Head restraints	37
Heated mirrors	33
Heated rear window	35
Heated steering wheel	65
Heating	41, 42
High beam	81, 99
High beam assist.....	81, 100
High voltage devices and wiring	222
Home menu.....	112
Horn	11, 66

I

Identification plate	249
Immobiliser	31, 81
Indicators.....	74
Inductive charging.....	70
Info Display.....	85
Information displays.....	82
Infotainment control panel.....	107
Instrument cluster	72
Instrument panel fuse box	227
Instrument panel illumination	
control	103
Instrument panel overview	8
Intellitext.....	123
Interior care	245
Interior lighting.....	103
Interior lights	103
Introduction	0

iPod.....	125
Connecting device.....	125

J

Jump starting	240
---------------------	-----

K

Key, memorised settings.....	20
KeyPass.....	27
Keys	16
Keys, locks.....	16

L

Lane change alert.....	181
Lane keep assist.....	80, 190
Lashing eyes	61
Lifting the vehicle.....	210
Light switch	98
Load compartment	29, 59
Load compartment cover	60
Loading information	62
Location based charging.....	196

M

Manual seat adjustment.....	39
Maximum speed.....	231
Maximum startup volume.....	115
Memorised settings.....	20
Menu operation.....	112
Mirror adjustment	6
Misted light covers	103

Mobile phones and CB radio equipment	139
Movie files.....	125
Mute.....	109

N

New vehicle running-in	148
Number plate light	221

O

Object detection systems.....	173
Odometer	74
One-pedal driving.....	153
OnStar.....	93
Operation.....	136, 153
External devices.....	125
Menu.....	112
Phone.....	136
Radio.....	119
Outside temperature	68

P

Pairing.....	133
Panoramic view system.....	183
Parking	15, 151
Parking assist	173
Parking brake	158
Parking lights	102
Pedestrian detection.....	81
Pedestrian safety alert.....	11, 66
Performance	251

Performing work	211
-----------------------	-----

Phone

Bluetooth.....	133
Bluetooth connection.....	133
Call history.....	136
Emergency calls.....	135
Entering a number.....	136
Functions during a call.....	136
General information.....	133
Incoming call.....	136
Phone book.....	136
Phone main menu.....	136
Selecting the ring tone.....	136
Speed dial number.....	136
Phone book.....	136
Phone projection.....	131
Picture files.....	125
Playing audio.....	127
Playing movies.....	130
Post-crash label.....	151
Power button.....	148
Power indicator gauge.....	76
Power outlets	69
Power windows	34
Programmable charging.....	196
Programmed charging override..	203
Propulsion system data.....	251

R**Radio**

Activating.....	119
Configuring DAB.....	123
Configuring RDS.....	122
DAB announcements.....	123
Digital audio broadcasting (DAB).....	123
Favourite lists.....	120
Intellitext.....	123
Radio data system (RDS).....	122
Regional.....	122
Regionalisation.....	122
Selecting the waveband.....	119
Station search.....	120
Station tuning.....	120
Usage.....	119
Radio data system	122
Radio Frequency Identification (RFID).....	261
Radio remote control	17
RDS.....	122
REACH.....	255
Reading lights	104
Rear cross traffic alert.....	186
Rear floor storage cover	60
Rear fog light	81, 102, 220
Rear seats.....	42
Rear view camera	184
Rear window wiper and washer . .	68

Recommended fluids and lubricants	247
Regenerative braking.....	76, 160
Regional.....	122
Regionalisation.....	122
Registered trademarks.....	258
Retained power off.....	150
Reversing lights	103
Ride control systems.....	161
Ring tone	
Changing the ring tone.....	136
Ring tone volume.....	115
Roof load.....	62
Roof rack	62

S

Safety belts.....	42
Seat adjustment	5
Seat belt	6
Seat belt reminder	77
Seat belts	42
Seat heating	
Seat heating, front.....	41
Seat heating, rear.....	42
Seat position	38
Self-sealing tyres.....	230
Service	146, 246
Service display	77
Service information	246
Service vehicle soon	79

Side airbag system	48
Side blind zone assistant.....	180
Sidelights.....	98
Side turn lights	220
Smartphone.....	125
Phone projection.....	131
Smartphone remote function.....	27
Software acknowledgement.....	256
Software update.....	257
Speech recognition.....	132
Speed dial numbers.....	136
Speed limiter.....	81, 164
Speedometer	74
Sport mode	80
Starting and operating.....	148
Starting and stopping the vehicle	150
Starting off	14
Station search.....	120
Steering wheel adjustment	7, 65
Steering wheel audio controls....	107
Steering wheel controls	65
Storage.....	57
Storage compartments.....	57
Sunvisor lights	104
Sun visors	36
Switching the Infotainment system on.....	109
Symbols	3
System settings.....	116

T

Tail lights	220
Target charge level.....	196
Temporary charge mode cancel.	196
Temporary charge mode override.....	196
Theft-deterrent feature	106
Three-point seat belt	43
Tone settings.....	114
Tools	230
Total vehicle range.....	77
Touch beep volume.....	115
Towing.....	242
Towing another vehicle	243
Towing the vehicle	242
TP volume.....	115
Traction Control system	161
Traction Control system off.....	80
Traffic sign assistant.....	82, 187
Tread depth	234
Turn lights	77, 102
Tyre chains	236
Tyre designations	231
Tyre pressure	231
Tyre pressure monitoring system.....	80, 232
Tyre pressures	253
Tyre repair kit	236
Tyres	230

- U**
- Ultrasonic parking assist..... 173
 - Upholstery..... 245
 - Usage..... 109, 119, 132
 - AUX..... 125
 - Bluetooth..... 125
 - iPod..... 125
 - Menu..... 112
 - Phone..... 136
 - Radio..... 119
 - USB..... 125
 - USB
 - Connecting device..... 125
 - General information..... 125
 - USB audio menu..... 127
 - USB movie menu..... 130
 - USB picture menu..... 129
 - USB port..... 69
 - Using smartphone applications. . 131
 - Using this manual 2
- V**
- Vehicle battery 216
 - Vehicle checks..... 211
 - Vehicle data recording and
 - privacy..... 258
 - Vehicle detected ahead..... 81
 - Vehicle dimensions 252
 - Vehicle Identification Number 249
 - Vehicle messages 89
 - Vehicle personalisation 90
 - Vehicle ready..... 81
 - Vehicle security..... 29
 - Vehicle storage..... 210
 - Vehicle tools..... 230
 - Vehicle unlocking 4
 - Vehicle weight 251
 - Voice recognition..... 132
 - Volume
 - Auto volume..... 115
 - Maximum startup volume..... 115
 - Mute function..... 109
 - Ring tone volume..... 115
 - Setting the volume..... 109
 - Speed compensated volume. . 115
 - Touch beep volume..... 115
 - TP volume..... 115
 - Volume limitation at high
 - temperatures..... 109
 - Volume settings..... 115
- W**
- Warning chimes 90
 - Warning lights..... 74
 - Warning triangle 61
 - Washer and wiper systems 12
 - Washer fluid 215
 - Waveband selection..... 119
 - Wheel covers 235
 - Wheels and tyres 230
 - Windows..... 33
 - Windscreen..... 33
 - Windscreen wiper and washer 66
 - Winter tyres 231
 - Wiper blade replacement 218
- X**
- Xenon headlights 219

www.opel.com

Copyright by Opel Automobile GmbH, Rüsselsheim, Germany.

The information contained in this publication is effective as of the date indicated below. Opel Automobile GmbH reserves the right to make changes to the technical specifications, features and design of the vehicles relative to the information in this publication as well as changes to the publication itself.

Edition: July 2018, Opel Automobile GmbH, Rüsselsheim.

Printed on chlorine-free bleached paper.

ID-OAMBOBSE1807-en

